

Paper Mill Lane Works

Access Management Plan

Requirement 16 (1) and 27 (1)(c)

(Applicable to Work Numbers 50 and 51)

Prepared by:	Checked by:	Approved by:
<i>K Griffin, SLR</i>		

Revision Summary				
Rev	Date	Prepared by	Checked by	Approved by
1	31/08/21	Kay Griffin	Phil Williamson Rew-	Catherine Sibley
2	28/01/22	Kay Griffin	Phil Williamson Rew-	Gareth Mills
3	01/04/22	Kay Griffin	Phil Williamson Rew-	Gareth Mills

Description of Revisions			
Rev	Page	Section	Description
1	ALL	ALL	New Document
2	ALL	ALL	Amended in accordance with stakeholder comments: MSDC (23/11/21) and SCC (6/10/21, 15/10/21)
3	ALL	ALL	Amended in accordance with stakeholder comments SCC (25/2/22)

FOR DISCHARGE

TABLE OF CONTENTS

1. INTRODUCTION AND SCOPE	4
1.1. Project Overview	4
1.2. Purpose and Scope.....	4
2. ABBREVIATIONS	5
3. ACCESS MANAGEMENT PLAN GOVERNANCE	6
4. LOCAL COMMUNITY LIAISON	6
5. REQUIREMENTS AND STANDARDS	7
6. CONSTRUCTION DETAILS	7
6.1. Cable Works – Overview	7
6.2. Paper Mill Lane Works	8
6.2.1. Accesses AP-AF and AP-AG, Access Track, Haul Road and Trackway (Work No. 50)	8
6.2.2. Primary Construction Consolidation Site (Work No. 51).....	9
6.2.3. Jointing Bay 4 (Work No. 51)	9
6.2.4. Reinstatement	10
6.3. Temporary Infrastructure Access Locations	10
6.4. Construction Traffic	11
6.4.1. HGV Movements.....	11
6.4.2. Abnormal Load Movements	12
7. ACCESS MANAGEMENT	12
7.1. Access Strategy	12
8. ACCESS IMPROVEMENTS	14
9. HIGHWAY IMPROVEMENTS	17
10. REFERENCES	17
APPENDIX 1 NKT UK EA3 HVDC ROUTE COMMENCEMENT WORKS TRANSPORT ASSESSMENT APRIL 2022	18
APPENDIX 2 EAST ANGLIA THREE CONVERTER STATION AND PAPER MILL LANE WORKS TRAFFIC AND TRANSPORT TECHNICAL NOTE	19

FIGURES

Figure 1 Site Context Plan

Figure 2 Construction Access Route

1. INTRODUCTION AND SCOPE

1.1. Project Overview

1. East Anglia Three Limited (EATL) was awarded a Development Consent Order (DCO) by the Secretary of State, Department of Business, Energy and Industrial Strategy (DBEIS) on 7 August 2017 for the East Anglia THREE Offshore Windfarm (EA THREE). The DCO granted consent for the development of a 1200MW offshore windfarm and associated infrastructure and is live until 28 August 2022. The DCO has now been subject to three non-material variations:

- In March 2019 EATL submitted a non-material change application to DBEIS to amend the consent to increase the maximum generating capacity from 1,200MW to 1,400MW and to limit the maximum number of gravity base foundations to 100. In June 2019 DBEIS authorised the proposed change application and issued an Amendments Order.
- In July 2020 EATL submitted a second non-material change application to DBEIS to amend the parameters of its offshore substations (reducing the number of these to one) and wind turbines (a decrease in the number of turbines and an increase in their hub height and rotor radius). On 15 April 2021 DBEIS authorised this proposed change application and issued an Amendments Order.
- In August 2021 EATL submitted a third non-material change application to DBEIS to amend the consent to remove the maximum generating capacity of 1,400MW and to amend the parameters of its wind turbines (a decrease in the number of turbines and an increase in their hub height and rotor radius). The application is currently in the consultation phase.

2. The onshore construction works associated with EA THREE will have a capacity of 1,400MW and transmission connection of 1,320MW. The construction works will be spread across a 37km corridor between the Suffolk coast at Bawdsey and the converter station at Bramford, passing the northern side of Ipswich. As a result of the strategic approach taken, the cables will be pulled through pre-installed ducts laid during the onshore works for East Anglia ONE Offshore Windfarm (EA ONE), thereby substantially reducing the impacts of connecting to the National Grid (NG) at the same location. The infrastructure to be installed for EA THREE, therefore, comprises:

- The landfall site with one associated transition bay location with two transition bays containing the connection between the offshore and onshore cables;
- Two onshore electrical cables (single core);
- Up to 62 jointing bay locations each with up to two jointing bays;
- One onshore converter station, adjacent to the EA ONE Substation;
- Three cables to link the converter station to the National Grid Bramford Substation;
- Up to three onshore fibre optic cables; and
- Landscaping and tree planting around the onshore converter station location.

3. Since the granting of the DCO, the decision has been made that the electrical connection for EA THREE will comprise a high voltage direct current (HVDC) cable rather than a high voltage alternating current cable and, therefore, the type of substation that will be required is a HVDC converter station. The substation will, therefore, be referred to here as a 'converter station' and this amended terminology has been agreed with the relevant authorities on 15 October 2020. It has also been determined that only one converter station will be constructed rather than two and that the converter station will be installed in a single construction phase.

1.2. Purpose and Scope

4. This Access Management Plan (AMP) focuses on the procedures for managing the impact of access to the EA THREE Paper Mill Lane Works Stage of the EA THREE onshore construction works. This document has been produced to discharge DCO Requirements 16 (1) and 27 (1) (c) which state:

Highway accesses and improvements

16.—(1) *No stage of the connection works may commence until for that stage written details (which accord with the outline access management plan) of the siting, design, layout and any access management measures for any new, permanent or temporary means of access to a highway to be used by vehicular traffic, or any alteration to an existing means of access to a highway used by vehicular traffic, has, after consultation with the highway authority, been submitted to and approved by the relevant planning authority.*

Traffic

27. (1) *No stage of the connection works may commence until for that stage the following have been submitted to and approved by the relevant local planning authority in consultation with the relevant highway authority—...*

(c) an access management plan which must be in accordance with the outline access management plan.

5. The scope of this document relates to the AMP associated with the Paper Mill Lane Works Stage of the EA THREE onshore construction works, as part of the onshore cable route that runs from the landfall location at Bawdsey to the Converter Station works located near Bramford, Suffolk. These works comprise Work No.s 50 and 51 (Figure 1 Site Context Plan). Separate AMPs have been produced for each stage of the onshore connection works and are provided under separate cover. Highway improvements are addressed in this AMP.
6. The Paper Mill Lane Works will be some of the first works to be undertaken along the cable route. These works have been designated as a stage in their own right to allow the works to commence at this location prior to works commencing along the cable route as a whole (i.e. the main cable works construction phase). The Primary Construction Consolidation Site (PCCS) and the access to it will be constructed in Summer 2022 and the additional access construction, jointing bay installation, cable pull through and reinstatement will be undertaken as part of the main cable works construction phase.
7. This AMP sets out the location, frontage, general layout and visibility available for access onto the existing road network from each access point. A unique identification number has been allocated to each identified access point (A to AL). It presents the requirements and standards that have been incorporated into the final access design.
8. This AMP also considers the need for highway improvements and confirms that no highway improvements are required for the Paper Mill Lane Works.
9. EATL will work with the Suffolk County Council (SCC) Highways Department to ensure appropriate resourcing is in place to monitor compliance with the provisions of this AMP.
10. The measures contained herein will be adhered to by the Principal Contractor (and thereby all tiers of the construction workforce) and the implementation and compliance will be monitored by the Construction Management Team. These measures will only be revised with the agreement of SCC and Mid Suffolk District Council (MSDC).
11. This AMP takes account of the route surveys, assessments and route evaluations undertaken and has been developed in accordance with the Outline Access Management Plan (Document Reference 8.9 of the DCO application). This AMP also takes account of the lessons learned from the East Anglia ONE construction works.
12. This AMP is complemented by a Traffic Management Plan (TMP) (EA3-LDC-CNS-REP-IBR-000032) which details additional measures to facilitate vehicles (particularly HGVs) to safely access the main distributor highway network via identified access routes.

2. ABBREVIATIONS

AMP	Access Management Plan
Chapter 8	Guidelines for (Public) Highways signing, lighting and guarding
DBEIS	Department of Business, Energy and Industrial Strategy
DCO	Development Consent Order
DfT	Department for Transport
EA THREE	East Anglia THREE
EATL	East Anglia THREE Limited
ES	Environmental Statement
HGV	Heavy goods vehicle
HVDC	High voltage direct current
HX	Highways Improvement Point

MfS	Manual for Streets
MSDC	Mid Suffolk District Council
MW	Megawatt
PCCS	Primary Construction Consolidation Site
RTK	Real Time Kinetic
SCC	Suffolk County Council
SCCS	Secondary Construction Consolidation Site
SDD	Stopping Sight Distance
TCM	Traffic Control Measures
TCo	Traffic Co-ordinator
TMP	Traffic Management Plan

3. ACCESS MANAGEMENT PLAN GOVERNANCE

13. Prior to the commencement of construction, a Traffic Co-ordinator (TCo) will be appointed by the Principal Contractor. Their key responsibilities will include:
- Managing the implementation of the AMP, the TMP and the Travel Plan;
 - Reporting on a quarterly basis to MSDC and SCC with respect to these plans and their monitoring targets; and
 - Acting as a point of contact for construction workers and sub-contractors.
14. Contact details for the TCo (and any subsequent personnel changes) will be submitted to stakeholders for their records prior to commencement of construction.

4. LOCAL COMMUNITY LIAISON

15. EATL is committed to providing clear communication to local residents and will manage public relations with local residents and businesses that will be affected by construction traffic. Proactive community liaison will be maintained, keeping local residents informed of the type and timing of works involved, the transport routes associated with the works, the hours of likely construction traffic movements and key traffic management measures. As outlined in the Code of Construction Practice (EA3--LDC-CNS-REP-IBR-000065), a combination of communication mechanisms such as posters, notices, exhibitions, letters, newsletters, website updates and parish council meetings will be employed to keep local residents and businesses informed.
16. A designated EA THREE Community Liaison Officer (CLO) will manage and respond to any public concerns, queries or complaints in a professional and diligent manner as set out in the Community Liaison and Public Relations Procedure contained within the Code of Construction Practice (EA3--LDC-CNS-REP-IBR-000065). The Complaints Procedure will be publicised and complaints will be directed to the EATL Community Liaison Officer. All enquiries will be logged, investigated and rectifying actions taken when deemed appropriate. Enquiries will be dealt with in an expedient and courteous manner. Details of complaints will be reported to MSDC and SCC within 48 hours.
17. The CLO will liaise with Parish Councils to identify any local activities that may overlap with the construction works. EATL's Land Team will also speak to landowners regarding the timing of harvest and agricultural activity.
18. Parish Councils, District Councillors and County Councillors including Ward Members and Portfolio Holders, in the area and the local liaison group will be contacted (in writing) in advance of the proposed works and ahead of key milestones in order to advise them of the ongoing works. The information provided will include a timetable of works, a schedule of working hours, the extent of the works, and a contact name, address and telephone number in case of complaint or query.
19. As part of the Traffic Management Plan (EA3-LDC-CNS-REP-IBR-000032) (TMP), all transport related to the construction of the EA THREE onshore connection will be registered and issued with a unique vehicle identification code. This will be included on an identification sticker/board that will be placed in a prominent position on the vehicle to enable the site management team and members of the public to identify the vehicle and its association to EA THREE. This will be monitored by the TCo (see Section 4 of the TMP). This scheme shall be submitted to and approved by SCC. Details of the scheme will also be shared with MSDC. SPR

construction vehicles will have a defined identification livery so that they are immediately identifiable to construction staff and third parties.

5. REQUIREMENTS AND STANDARDS

20. This AMP and the works detailed within comply with the following guidance and standards:

- New Roads and Street Works Act 1991;
- Highways Act 1980;
- Design Manual for Roads and Bridges;
- HSG47: Avoiding danger from underground Services (Third edition, 2014);
- Safety at Street Works and Road Works: A Code of Practice, 2014; and
- Department for Transport’s Chapter 8: Traffic Safety Measures and Signs for Road Works and Temporary Situations Parts 1 and 2.

21. The design of the access and highway improvement works presented in this document have been reviewed and approved by SCC Highways Authority prior to inclusion in this plan.

6. CONSTRUCTION DETAILS

6.1. Cable Works – Overview

22. The construction works will be spread across a 37km corridor between the Suffolk coast at Bawdsey and the Converter Station at Bramford, passing the northern side of Ipswich. The cables will be pulled through pre-installed ducts laid during the onshore works for East Anglia ONE. The construction activity within each section along the onshore cable route will be as follows:

- Any minor temporary modifications to the public road network;
- Establish the Construction Consolidation Sites (CCSs);
- Establish accesses to, and temporary haul road to, the jointing bay locations;
- Establish temporary jointing bay compounds;
- Excavate jointing bay pit to locate the existing ducts at each of the compounds;
- Construct jointing bay;
- Transport of cables to site, pull cables through ducts and undertake jointing;
- Topsoil replacement and seeding;
- Remove temporary compounds (jointing bays and CCS); and
- Reinstatement all disturbed land and permanent fences and hedges.

23. Some temporary modification of the existing road networks may be required such as localised widening, temporary widening or socketing of street signs and temporary moving of street furniture in order to allow larger vehicles than normal to access the jointing bays. This will be completed prior to the start of the main construction works within relevant sections of the cable corridor route.

24. EATL will require up to seven temporary construction compounds to aid in the construction of the proposed East Anglia THREE project. These have been designated as ‘Primary Construction Consolidation Site’ (PCCS) and ‘Secondary Construction Consolidation Site’ (SCCS) depending on their uses. Two PCCS and up to five SCCS will be installed, which will all be temporary and will be removed once construction is complete.

Table 6-1 – Construction Consolidation Site Locations

CCS Type	ID	Address
Secondary	A	Bullen Lane, Bramford, Ipswich, Suffolk IP8
Primary	B	Paper Mill Lane, Claydon, Ipswich, Suffolk IP6 0AP
Secondary	C	Witnesham Road, Ipswich, Suffolk IP6
Secondary	D	Playford Corner, Playford Mount, Ipswich, Suffolk IP6 9DS
Primary	E	Top Street, Martlesham, Suffolk IP12
Secondary	F	Clappits, Woodbridge Road, Newbourne, Woodbridge, Suffolk IP12 4PA
Secondary	G	Park Lane, Ipswich, Suffolk IP10

25. The PCCSs will:

- Form the main point of access onto the linear construction site;
- Provide areas for the storage of materials and equipment;
- House site administration and welfare facilities for the labour resources;
- Form an interchange hub for deliveries of material, equipment and resources; and
- Allow HGVs to park prior to entering the local road network during peak hours.

26. The SCCSs will act as hubs for the delivery of materials, equipment and resources along the route and will enable access to the cable route for construction. They will be of sufficient size to accommodate limited storage of materials, equipment and labour welfare facilities.
27. It is anticipated that 29 jointing bays will be required along the 37km cable route, in addition to a transition bay at the landfall. Each jointing bay will comprise a concrete box 10m long by 3m wide by 1.5m high buried so that the base is 2.5m below ground level. A jointing bay construction compound will be required adjacent to each jointing bay and will have hardstanding areas of up to 900m² within the compound which would typically measure 24m x 115m i.e. 2,760m². (in accordance with Requirement 12(11) which stipulates that the footprint must not exceed 3,740m²). The compounds will have hardstanding and accommodate containers, drum trailer movement, parking, and welfare. A typical layout is shown in Figure 2 of the Code of Construction Practice (EA3-LDC-CNS-REP-IBR-000065).
28. Existing accesses and farm tracks will be upgraded and used where possible to access the jointing bay locations. Once these accesses reach the cable corridor, the routes to connect to the jointing bays are referred to as 'haul road'. The length of haul road for the cable route is limited by Requirement 12(12) of the DCO to 18.05km.
29. In addition, the ducts to be used for EA THREE, which were installed during the EA ONE project construction works, will require to be 'proved' to ensure that they are intact and free of debris. This will be undertaken by the use of foam pigs which will be driven under pressure from jointing bay to jointing bay. Each stretch of duct that was installed using Horizontal Direct Drilling (HDD) will, however, require duct-proving excavations at each end of the HDD, to allow the use of different size foam pigs, due to a difference in the diameter of these compared to the ducting installed using open trench techniques.

6.2. Paper Mill Lane Works

30. Paper Mill Lane Works comprise a stage of the onshore connection works and cover Work No.s 50 and 51. The infrastructure within these work no.s comprises:
- The Paper Mill Lane PCCS in Work No. 51;
 - Jointing Bay 4 in Work No. 50;
 - Two new accesses with the public road (Paper Mill Lane) as follows:
 - Access AP-AF to the east of Paper Mill Lane, to access the PCCS and Jointing Bay 4; and
 - Access AP-AG to the west of Paper Mill Lane to access the ends of the HDD ducts;
 - The access track/haul road required to access the PCCS and Jointing Bay 4;
 - Two stretches of trackway to reach duct proving excavations at the ends of the HDD ducts in the Work No.s to the east and west of the Paper Mill Lane Works; and
 - Turning circle and HGV parking area in Work No 51 to allow HGV movements to be safely coordinated.

31. These works are shown on Figure 1.

32. Paper Mill Lane PCCS and the two accesses from Paper Mill Lane were used as part of the EA ONE construction works and have now been reinstated, other than part of the access to the east which has been partially reinstated, and so will need to be constructed again under the EA THREE DCO. There are no public rights of way within the site.

6.2.1. Accesses AP-AF and AP-AG, Access Track, Haul Road and Trackway (Work No. 50)

33. Paper Mill Lane PCCS and the Jointing Bay will be accessed from Paper Mill Lane using Access AP-AF. This access was used for the EA ONE project and has now been partially reinstated. Planning permission has been granted for the access that remains (Reference DC/20/05669). From Access AP-AF, a new temporary vehicular access track of 180m length and 5.5m width will be used to access the Paper Mill Lane PCCS and also reach the edge of the cable corridor (Work No. 50), where 90m of 5.5m wide haul road will link to the jointing bay. From here, 140m of 5.5m wide trackway will be installed to reach the excavation point on the HDD ducts in Work No. 49. Of this trackway, 90m will be within Work No. 49 and is not part of the Paper Mill Lane Works.

34. An access (Access AP-AG) will also be required on the west side of Paper Mill Lane, along with a 185m length of trackway to reach the proposed HDD duct proving excavation in Work No. 52 during the main cable works. Only 33m of this trackway will be within the Paper Mill Lane Works.

35. No watercourse crossings will be required for the Paper Mill Lane Works.

36. The construction methodologies associated with the access, access track and haul roads are typically as follows:

- Set out the access and track/haul road with the use of Global Positioning Systems (GPS) Real Time Kinematic (RTK) equipment;
- Locate, divert and cap any existing field drains;
- Set out and install drainage features the length of track to be constructed;
- Remove vegetation, then remove and locally store topsoil material over the working width; seeding topsoil if it is to be stored for longer than 6 months;
- Excavate to formation level and store any excess material;
- Under-track drainage will be installed where necessary and in accordance with drainage requirements;
- Place a geotextile onto existing subsoil to improve the bearing capacity of the sub-soil, depending on ground conditions, programme and landowner requirements;
- Place imported stone in accordance with the design to form the track structure; and
- For the trackway, following the setting out of the route using GPS RTK, the trackmatting would be installed directly on the existing ground surface.

6.2.2. Primary Construction Consolidation Site (Work No. 51)

37. The Paper Mill Lane PCCS (CCS B) will be a designated storage and delivery facility and also the main administrative compound for the onshore cable works. The dimensions of the PCCS at Paper Mill Lane will be 90m long by 40m wide covering a surface area of 3,600m², this is in accordance with Requirement 12(9)(a) which limits the size of each PCCS to 3,600m². The Paper Mill Lane PCCS will also be within the area previously used for the EA ONE PCCS in this location.

38. The construction of the PCCSs involves stripping of topsoil, importing and laying stone for the compound base and installing cabins and welfare facilities. Construction of the Paper Mill Lane PCCS will take approximately 3 weeks and the methodology will be as follows:

- The extent of PCCS will be marked out with the use of GPS RTK equipment;
- Any existing field drains will be located, diverted and capped;
- Drainage features will be set out and installed as required;
- Security fencing will be erected around the perimeter of the PCCS;
- Once vegetation has been removed, topsoil material over the PCCS area will be removed and locally stored and seeded if it is to be stored for longer than 6 months;
- Any excess material will be excavated to formation level and stored; and
- Imported stone will be placed in accordance with the design of the PCCS base structure.

39. An HGV queuing area (195m²), turning circle (303m²) and parking up area (447m²) will also be required adjacent to the PCCS. This will enable a key part of the EA THREE traffic strategy which requires any HGVs arriving via the strategic road network during peak hours to park up at the Primary CCS, as HGVs will only be permitted to enter the local road network during permitted delivery windows (generally 9am-4.30pm (see Table 6-2 of the Traffic Management Plan (EA3 LDC-CNS-REP-IBR-000039))).

40. The Paper Mill Lane PCCS will be constructed first in summer 2022, with the duct proving, jointing bay and cable pull through occurring at a later date (anticipated in 2024). It is intended that the PCCS will provide an early onsite presence for the onshore cable construction works and will be used as a base for mitigation and survey works being undertaken as well as for the construction team to visit site during the later stages of the planning and design process. It will also be used for stakeholder and other site meetings.

41. The Paper Mill Lane PCCS will remain in situ for the duration of the onshore cable works, prior to being restored as described in Section 6.2.4.

6.2.3. Jointing Bay 4 (Work No. 51)

42. The jointing bay will be located within Work No. 50, 150m to the south east of the PCCS at OS Grid Reference 613067, 248933.

43. Once the location of the jointing bay compound has been established (using GPS RTK equipment), creation of the compound will commence with erection of temporary security fencing, removal of topsoil layer and installation of hardstanding areas.
44. The jointing bay will then be excavated to a depth of up to 2.5m with adequate slope batter or shoring on all sides of the excavation to prevent the soil from collapse. The existing ducts will be uncovered and concrete slabs constructed to provide a level working area. Two sump pits will be included to facilitate drainage and dewatering and water will be treated, where necessary, before being discharged. Installation and jointing of the cables will then take place, along with installation of earthing link boxes and fibre optic cable chambers, before the area is back filled with subsoil.
45. The creation of the jointing bay compound and excavation of the jointing bay will each take a week.

6.2.3.1. Cable Installation

46. The electrical transmission cables will be delivered to the CCS, from where they will be transferred to the jointing bay compound when needed. The cable drums will comprise abnormal loads and their delivery will be managed as set out in the Traffic Management Plan (EA3-LDC-ONCS-REP-IBR-000032). Two cable lengths of approximately 1,260m will be required to pull through between each pair of jointing bays. The cable ducts will be proved before the cable is pulled through. Once the cables are received at the jointing bay compound, they will be temporarily stored on the hardstanding area prior to installation in the pre-installed ducts.
47. Installation of the cables into the ducts between Jointing Bay 4 and Jointing Bay 3 (not part of the Paper Mill Lane Works) will begin with a cable pulling system being installed into the bay. A steel bond and winching system with free spinning rollers will be installed along the bottom of the bay. Hydraulic jacks will raise the cable drum off the ground and a winch will be used to pull in cable using a pulling rope. A dynamometer will ensure the maximum pulling tension is not exceeded. Tension on the cable will be reduced using a biodegradable water-based lubricant. This process will be repeated for the second cable being installed in the duct. The cables will then be jointed once 2 cable sections (4 cables) have been installed.
48. It is expected that pulling and jointing operations would take approximately 2.5 weeks, typically spread over a three to four week period, with approximately five workers for each jointing bay. These works will then be repeated to install the cables between Jointing Bays 4 and 5.

6.2.4. Reinstatement

49. Following installation and jointing of the cables, the jointing bay, jointing bay compound, access and haul road will be reinstated with the stored topsoil and subsoil following trenching. If necessary, the subsoil will be 'ripped' prior to placement if compaction had occurred. Topsoil will be spread in such a way as to ensure that it does not become compacted. The topsoil will then be cultivated and reseeded (if required) and suitable hedgerow species replanted during the first appropriate planting season, in accordance with the Landscape Management Plan (EA3- LDC-ONCS-REP-IBR-000064). Temporary fencing around any new planting would be removed once reinstatement was established.
50. Trackway will be removed following installation of the cables in the adjacent Work No.s.
51. The PCCS will remain in situ for the duration of the cable works and will then be removed and reinstated as outlined above..

6.3. Temporary Infrastructure Access Locations

52. Figure 1 and Table 6-2 present the location of the two accesses required for the Paper Mill Lane Works. These accesses were both used for the EA ONE construction works. All new junctions will be finished with an Asphalt Surface Course with the minimum length of surfacing from the existing road channel to the security gate being 20m. The access road from the security gate at Access AP-AF into the car park of the PCCS will also be bound surfacing.

Table 6-2 Temporary Infrastructure Access Locations

ID	Address/Location	Easting	Northing	Access ID
Paper Mill Lane CCS	Paper Mill Lane, Claydon, Ipswich, Suffolk IP6 0AP	612843	249077	AP-AF
HDD (HDD-4) Excavation	Paper Mill Lane, Claydon, Mid Suffolk, Suffolk, IP8 4DE	612805	248970	AP-AG

6.4. Construction Traffic

6.4.1. HGV Movements

53. Chapter 27 Traffic and Transport of the ES for the East Anglia THREE project has assessed the environmental impact of traffic on the routes within the onshore highway study area across a range of effects, namely:

- Pedestrian amenity;
- Severance;
- Road safety; and
- Driver delay.

54. The ES included peak hour assessments (i.e. between 08:00-09:00 and 17:00-18:00) which give details of the maximum peak hour HGV movements. The overall assessment concluded that appropriate mitigation measures would ensure that the environmental impacts would not be 'significant'.

55. Following further design works by the selected Principal Contractor for the cable works (NKT) and also by the Principal Contractor for the converter station (Siemens Energy), an updated transport assessment (the scope for which is set out in paragraph 56) has now been carried out and is included here as Appendix 2 East Anglia Three Converter Station and Paper Mill Lane Works Traffic And Transport Technical Note (the Traffic and Transport Technical Note). The Traffic and Transport Technical Note provides an overview of the changes to the vehicle numbers associated with the construction of the Paper Mill Lane Works, the nearby cable works and also the Converter Station Stage in order to consider all project-related traffic on the road network to be used for the Paper Mill Lane Works.

56. The Traffic and Transport Technical Note sets out the following:

- A summary of the assessment assumptions and resulting vehicle numbers associated with the construction of the Paper Mill Lane Works, the Converter Station Stage and also relevant cable works as identified in the ES;
- A summary of the assessment of vehicular impact associated with the construction of these EA THREE works, on the highway network in the ES;
- A summary of the potential assessment requirements of vehicular impact associated with the construction of these EA THREE connection works on the highway network, following the issue of the DCO;
- A summary of the difference between the vehicle movements identified in the ES and the actual vehicle movements identified by NKT and Siemens Energy, based on a lower car occupancy (1.5) than presented in the ES (2.5), for a robust assessment;
- A summary of the anticipated total vehicle movements associated with the construction of these EA THREE works including the revised vehicle movements, at the locations potentially requiring assessment on the highway network;
- A review of the likely impacts at the sensitive junctions on the highway network that are likely to be used by traffic associated with the construction of the Paper Mill Lane Works and Converter Station Stage (including for relevant cable works).
- A junction capacity assessment is included of the identified sensitive junction (Junction 1: A14/B1113 Claydon Interchange) to test the impact of the confirmed EA THREE traffic data at this junction, using the most recent baseline traffic data available and incorporating vehicle movements associated with various committed developments. The assessment confirmed there would be no capacity issues at the junction with the addition of the EA THREE vehicle movements.
- A review of road safety on the routes that would be used by the construction traffic associated with the construction of the Paper Mill Lane Works, the Converter Station Stage and the relevant cable installation works (Sections 8 to 11) shows there are no road safety issues that would be exacerbated by an increase in traffic flows and that no additional traffic management measures are required.

57. The maximum daily and evening peak vehicle movements presented in Appendix 2 are summarised in Table 6-3. This is based on a car occupancy of 1.5, which has been identified from lessons learnt from the East Anglia TWO and East Anglia ONE North Offshore Windfarm' Environmental Statements and DCO Examinations, advice from SCC and through discussions with NKT and Siemens Energy, who have suggested that a 2.5 car occupancy is unlikely to be achievable.

Table 6-3 Confirmed Maximum Figures (NKT and Siemens Energy)

	Employees				HGV Movements	
	Number		Vehicle Movements		Daily	PM Peak
	Daily	PM Peak	Daily	PM Peak		
Paper Mill Lane Works including relevant cable installation works (Sections 8 to 11)	60	60	80	40	20	2
Converter Station Stage	130	130	174	87	68	8
	190	190	254	127	88	10

58. A Construction Access Route Assessment (ref 371024-TRNS-REP-002, Rev 002) was undertaken prior to the construction of the EA ONE onshore electrical connection to evaluate the Local Access Routes of the construction road network, which do not form part of the Suffolk Lorry Route Network. The assessment included:

- An on-site engineering survey;
- An assessment and route evaluation of the construction access routes for the delivery of equipment, construction plant, materials; and
- The construction workforce along the Local Access Routes.

59. The assessment determined that the local access roads identified present viable and safe routes for use by the EA ONE construction traffic over the duration of the onshore construction works, subject to the implementation of mitigating measures and temporary road improvements. A further route assessment has been undertaken for, *inter alia*, Paper Mill Lane Works by Fairhursts on behalf of NKT and is included as Appendix 1 (NKT UK, EA3 HVDC Route Commencement Works Transport Assessment, April 2022). The route assessment considered safe access arrangements, the use of passing places and the requirements for advance warning signage, together with any weight restrictions, and any obstructions which may compromise the transportation of equipment. This confirms the suitability of the route between Access AP-AF and Access AP-AG and the main road network (i.e. the Suffolk Lorry Route Network) such that no highway improvements are required.

60. Mitigating measures have been developed in sufficient detail within this AMP and also the TMP to enable the Highway Authority, and other affected parties, to maintain the safety and level of service upon the existing transport network.

6.4.2. Abnormal Load Movements

61. The installation of the cables for EA THREE are likely to require the delivery of 4 cable drums to the Paper Mill Lane CCS. Due to their weight (likely to be in excess of 50 tonnes), these will comprise Abnormal Indivisible Loads (AIL) (either Category 2 or Category 3). These will be delivered via specialist means and offloaded, for example by use of a mobile crane (see Section 6.3 of the TMP for details of abnormal load transport procedures). The SCC Highways Structures Team will be consulted to confirm that the highways structures can carry the proposed loads. Delivery of AIL will be undertaken in consultation with Suffolk Constabulary.

7. ACCESS MANAGEMENT

7.1. Access Strategy

62. The EA THREE access strategy is predicated on using the most efficient payload vehicle for delivery of materials (e.g. 20 tonne payload for stone deliveries) and therefore negates the need to downsize to smaller vehicles and double handle materials, minimising potential HGV movements on the highway network.

63. This has meant the scale of accesses has to be suitably sized to enable HGVs to gain access. During consultation, the public expressed concerns on access scale, fearing large over designed accesses which would look out of character with the surrounding landscape causing irrevocable environmental impacts. With this in mind, all access designs have taken a sensitive approach and hard engineering methods have been minimised to reduce impact on the surrounding environment.
64. The EA THREE Environmental Statement identified 37 potential points of access for the construction of the onshore cable route, in order to allow points of access for HGV traffic to access the two Primary CCS, five Secondary CCS, and up to 62 jointing bay locations. Where possible, existing points of access situated close to the jointing bay locations were selected. Where a suitable route / track is not available, a temporary haul road will be used to access the jointing bays. This strategy has resulted in a reduction in the amount of temporary haul road required from approximately 35km for East Anglia ONE to a maximum of 18.05km for the proposed EA THREE project (actual length is to be calculated following completion of the design of the cable route as a whole) in accordance with Requirement 12 (12) of the DCO. Noting that the transport of stone for temporary haul roads is one of the largest traffic generators for the project (approximately 600 two-way HGV movements to install and remove a kilometre of haul road) this strategy serves to significantly reduce the daily demand for HGV traffic.
65. A number of the accesses have been utilised for the construction of the East Anglia ONE onshore electrical transmission works, however the majority of these have now been removed and restored to their original condition.
66. Two accesses are required for the Paper Mill Lane Works. These are referred to as Accesses AP-AF and AP-AG (See Figure 1 and Table 7-1). The location of these differ slightly to the locations shown on the Access to Works Plans submitted as part of the DCO application. The accesses have been re-located to the accesses used during the EA ONE project to minimise ground and habitat disturbance and so that the previously agreed access designs can be utilised. Access AP-AF was previously known as AX-05 and will be used to access the PCCS. This access benefits from planning permission which allows it to be retained in part. Access AP-AG was previously known as AX-04 and will be used to access the HDD excavation (HDD-4) in Work No. 52.
67. The locations of these accesses are summarised within Table 7-1. Figure 2 graphically depicts the access locations in relation to the project and the wider highway network.

Table 7-1 Proposed Access Details

Access ID	Location of Access	Destination of Access	Used on EA ONE?	Description of Access Use
AP-AF	Paper Mill Lane	CCS B, Jointing Bay 4 and HDD-5	Yes -Access AP-AF was known as access AX-05 and is currently subject to a planning application to become a permanent access	Access to CCS site and cable route east from Paper Mill Lane
AP-AG	Paper Mill Lane	HDD 4	Yes – Access AP-AG was known as Access AX-04 but has now been fully reinstated.	To be used to access HDD-04 in Work No. 52

68. Maintenance of the access points will be carried out via daily inspections by the site management team reporting of defects. Maintenance of access points within the highway boundary shall be in accordance with the Suffolk Highways Highway Maintenance Operational Plan (2021). Regular road sweeping and use of portable wheel washing facilities at strategic locations shall prevent contamination of the adjacent highways.
69. The following procedures shall be adopted to manage the impact of access during the construction works:
- All access arrangements (including permitted access times) will be included in the briefing to all site staff at induction stage;
 - All access routes will be given a unique identification number and each will have signage displaying the identification number;
 - The access point will have appropriate advance warning signage;
 - All gates will be manned or locked daily when there is no construction activity;
 - The access point will have grit bins placed at the entrance way;
 - Wheel wash facilities will be installed at strategically selected access points, including Access AP-AF and used when necessary to prevent mud or debris being carried onto the public highway;
 - Drainage will be provided to prevent water flowing from the site access onto the public highway; and
 - All Contractors will be advised of the TMP (EA3-LDC-CNS-REP-IBR-000032) and this AMP prior to engagement by EATL.

70. Following construction (and unless otherwise agreed with SCC and the relevant planning authority), access AP-AG be reinstated to their original condition. Access AP-AF will be reinstated to the layout set out in the associated planning permission. Any works identified by SCC as having legacy benefit (e.g. by improving road safety or increasing asset life) would also be retained.

8. ACCESS IMPROVEMENTS

71. The layouts of both AP-AF and AP-AG were previously approved by SCC prior to the commencement of the EA ONE construction works and also underwent a Stage 1/2 Road Safety Audit, along with a Stage 3 Road Safety Audit, in accordance with the requirements of the DMRB publication GG119. Due to the successful operation of these previously approved junctions, the proposal is to reinstate each junction to the exact specification of those previously approved (Refer to drawing number 146103/1000 for details (Appendix 1).
72. The layout for these accesses onto the public highway has been designed for the level of traffic flows predicted at time of use of the access and the predicted level of turning movements and sizes of vehicles required during the construction period. All access arrangements have been designed to accommodate two-way traffic and provide for standing vehicles clear of the through carriageway. Each access gateway will be off-set to a minimum of 20m from the existing carriageway edge so that vehicles arriving can wait in front of the gates without queuing on the highway. Gates will, in all cases, open away from the highway.
73. Advance hazard warning signs will be provided in accordance with the Traffic Signs Manual, Chapter 8, Traffic safety measures and Signs for Road Works and Temporary solutions, Parts 1 and 2, commonly referred to as Chapter 8. This signage will encourage drivers to slow in the knowledge that there is a temporary hazard ahead such as the potential for turning vehicles. It is noted that despite the provision of 30mph speed limit signs, not all drivers may reduce their speed accordingly. It is therefore proposed that road safety at the junction is continuously reviewed (for example through consideration of records of near misses) and if required, the need for further traffic calming measures will be agreed with SCC.
74. The TMP (EA3-LDC-CNS-REP-IBR-000032) details the measures to facilitate vehicles (particularly HGVs) to safely access the main distributor highway network via the identified access tracks and minor routes. Additional measures such as pilot vehicles, highway widening and passing places are not required to access the Paper Mill Lane Works.
75. Drawings 146103-1000 provided in Appendix 1 show the full details of the access improvements, including extent of the highway frontage. These drawings detail the junction layout, achievable visibility splays and the maximum speed compliant visibility splay achievable. Table 8-2 cross references to the drawings and details the traffic management measures required for each access.

Table 8-2 Access Measures

Access ID	Access Drg	Peak hourly HGV flows	Existing speed limit (mph)	Visibility compliance* for existing design speed (Y/N)	Temp. speed Limit (mph)	Visibility compliance* for proposed design Speed (Y/N)	50kph characteristic (Y/N)	Further traffic control measures (Y/N)	Notes
AP-F	14610 3-1000	3	60	Yes	30	Yes	Yes	Yes	<p>AX-05 to the east of Paper Mill Lane, was used during the construction of the EA ONE works. This junction has been partially reinstated by removing the filter lane, however the majority of the asphalt surfaced junction and security gate remain in position. In order to reinstate the junction to the previously approved standard, the filter lane on approach from the north will require to be fully reinstated.</p> <p>Install new asphalt surfaced filter lane to 3.5m width beyond the existing channel line of Paper Mill Lane. Adjust junction radii to the northern side of the junction to be 15.5m. Filter lane length to be 24.5m, with a 22.4m taper back to the channel line of Paper Mill Lane.</p> <p>Install advance warning signage on approach to and at the new junction location.</p> <p>It is not anticipated that any vegetation trimming will be required in order to achieve the require visibility splay of 2.4m x 90m in each direction from the centerline of the junction.</p>

Access ID	Access Drg	Peak hourly HGV flows	Existing speed limit (mph)	Visibility compliance* for existing design speed (Y/N)	Temp. speed Limit (mph)	Visibility compliance* for proposed design Speed (Y/N)	50kph characteristic (Y/N)	Further traffic control measures (Y/N)	Notes
AP-AG	146103-1000	3	60	No	30	Yes	Yes	Yes	<p>Access AX-04, to the west of Paper Mill Lane, was used during the construction of the EA ONE works. This junction has been fully removed and will require to be fully reinstated to the same standard as previously approved under EA ONE.</p> <p>Install new asphalt surfaced bellmouth to a minimum width of 8.0m and length of 20m, with junction radii of 10m. Install security gate at change from asphalt surface to stone haul road.</p> <p>Install advance warning signage on approach to and at the new junction location.</p> <p>It is not anticipated that any vegetation trimming will be required in order to achieve the require visibility splay of 2.4m x 90m in each direction from the centerline of the junction.</p>
<p>*Visibility stopping sight distance in accordance with DMRB TD9/93 design speed of major road</p>									

9. HIGHWAY IMPROVEMENTS

76. To facilitate access to the onshore cable works, a number of highway improvements are required across the existing highway network, however, as noted in Section 6.4.1, none are required to enable safe access to the Paper Mill Lane Works.

10. REFERENCES

DfT, 2007, *Manual for Streets*, London, TSO

DfT, 2009, *Traffic Signs Manual, Chapter 8, Traffic Safety Measures and Signs for Road Works and Temporary Situations, Part 1: Design*. London, TSO

DfT, 2009, *Traffic Signs Manual, Chapter 8, Traffic Safety Measures and Signs for Road Works and Temporary Situations, Part 2: Operations*. London, TSO

DfT, 2014, *Safety at Street Works and Road Works: A Code of Practice*, London, TSO

Highways England, 2020, *Design Manual for Roads and Bridges CD 123 Geometric design of at-grade priority and signal-controlled junctions*, Revision 2, TSO

Highways England, 2020, *Design Manual for Roads and Bridges CD -109, Highway Link Design*, Revision 1, TSO.

Highways England, 2020, *Design Manual for Roads and Bridges GG 119 Road Safety Audit*, Revision 2. TSO

Suffolk County Council, Suffolk Guidance for Parking, Technical Guidance, Third Edition – May 2019, <https://www.suffolk.gov.uk/assets/planning-waste-and-environment/planning-and-development-advice/Suffolk-Guidance-for-Parking-2019-Adopted-by-SCC.pdf>

Suffolk Highways, *Highway Maintenance Operational Plan*, v2.1 May 2021 <https://www.suffolk.gov.uk/assets/Roads-and-transport/how-we-manage-highway-maintenance/Highway-Maintenance-Operational-Plan-May-2021.pdf>

**APPENDIX 1 NKT UK EA3 HVDC ROUTE COMMENCEMENT WORKS TRANSPORT
ASSESSMENT APRIL 2022**

FOR DISCHARGE

NKT UK

**EA3 HVDC Route
Commencement Works**

Transport Assessment

November 2021



NKT





**SCOTTISHPOWER
RENEWABLES**

FAIRHURST

CONTROL SHEET

CLIENT: NKT UK
PROJECT TITLE: EA3 HVDC Route, Commencement Works
REPORT TITLE: Transport Assessment
PROJECT REFERENCE: 146103
DOCUMENT NUMBER: 146103-DOC-02
STATUS: FINAL⁵

Issue & Approval Schedule			Name	Signature	Date	
	Prepared by	G Park			12/11/2021	
	Checked by	A Madden			12/11/2021	
	Approved by	S G Dickson			12/11/2021	
Revision Record	Rev.	Date	Status	Description	Signature	
	1	17/11/21	DRAFT 2	Design Team comments incorporated. Section 4 added in relation to Existing Services.	By	G Park
					Check	A Madden
					Approve	S G Dickson
	2	22/11/21	FINAL ¹	Section 3.4 relating to AP-W updated	By	G Park
					Check	A Madden
					Approve	S G Dickson
	3	23/12/21	FINAL ²	Drawings contained within Appendix 1 updated to take account of Red Line Boundary	By	G Park
					Check	A Madden
					Approve	S G Dickson
	4	11/03/22	FINAL ³	Reference to visibility splay dimensions updated	By	G Park
					Check	A Madden
					Approve	S G Dickson
	5	11/03/22	FINAL ⁴	Section 3.5 AP-H amendment to text	By	A Madden
					Check	G Park
					Approve	S G Dickson
	6	25/04/22	FINAL ⁵	Section 3.4 updated to reference the STOP/GO Method Statement. Appendix 2 added. All drawings contained in Appendix 1 updated.	By	G Park
					Check	A Madden
					Approve	S G Dickson

This document has been prepared in accordance with procedure OP/P02 of the *Fairhurst Quality and Environmental Management System*

This document has been prepared in accordance with the instructions of the client, NKT UK, for the client's sole and specific use. Any other persons who use any information contained herein do so at their own risk.

Contents

1.0 Introduction	1
2.0 Route Assessment	4
3.0 Access Junction Design & Public Road Crossings	9
4.0 Existing Services	14

Appendix 1 - Drawings

Appendix 2 - 146103-DOC-04 Method Statement for Traffic Control at Holly Lane

1.0 Introduction

1.1. Transportation Assessment Overview

Fairhurst has been appointed by NKT UK, on behalf of Scottish Power Renewables, to undertake an assessment of the transportation requirements associated with the commencement works for the East Anglia Three (EA3) cable installation project.

During construction of the East Anglia One project (EA1), ducts required for the future EA3 project were installed in the cable corridor from the landfall site at Bawdsey, to the new substation compound at Bullen Lane, Bramford. As part of the EA1 project, several sections of the existing local road network were upgraded to accommodate construction traffic, along with the construction of new access junctions into the cable corridor Construction Consolidation Sites (CCS). Improvement works included designated passing places and vegetation removal. On completion of the EA1 project, the majority the new access junctions were removed, however all of the passing places which were constructed on the local road network were retained at the request of Suffolk County Council.

This next phase of construction (EA3), will again require construction access into the cable corridor in order to re-establish various CCS compounds and sections of Haul Road, to facilitate access to the proposed Jointing Bay locations, to construct the Jointing Bays, and pull new cables through the previously installed ducts.

Several of the previously designed and approved access points which were constructed during the EA1 project will be re-instated to facilitate access, along with any new access points which were not part of the original scheme.

This document covers the assessment of the following commencement works:

Access Points:

- AP-F Paper Mill Lane (former AX-05 partially reinstated)
- AP-G Paper Mill Lane (former AX-04 reinstated)
- AP-H Newbourne Road (former AX-14 partially reinstated)
- AP-I Newbourne Road (New Access)
- AP-W Holly Lane (New Access)
- AP-X Playford (former AX-08 reinstated)

Public Road Crossing for the Haul Road:

- CR1 & CR2 (The Street, Newbourne)
- CR8 & CR9 (Church Road)

Route Assessment:

- B1079 at Grundisburgh, south towards AP-X, through to AP-W Holly Lane.

- A12 Roundabout west along Newbourne Road toward junction with Ipswich Road, then South along Newbourne Road towards AP-I and AP-H
- A14 Roundabout, southwards along Paper Mill Lane to AP-F and AP-G.

The location of the above commencement works is illustrated in Figure 1.

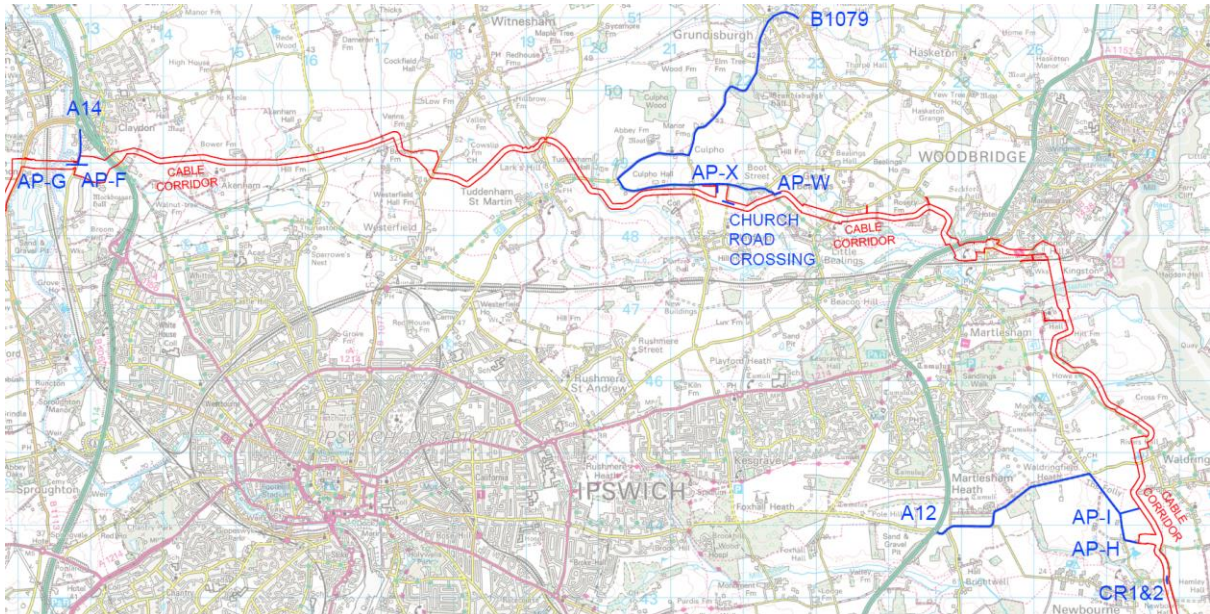
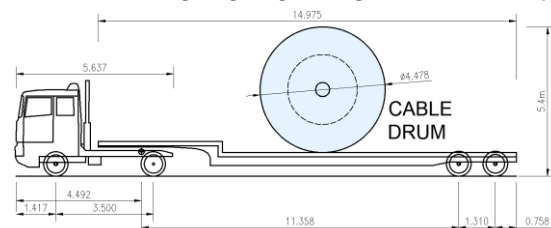

Figure 1: Location Plan

1.2. Scope of assessment

Route Assessment:

The proposed routes will be assessed from where they join the main road network, as indicated on the Suffolk Lorry Route Plan, along minor roads and towards each access point. The route assessment will consider safe access arrangements, the use of passing places and the requirements for advance warning signage, together with any weight restrictions, and any obstructions which may compromise the transportation of equipment. For the purpose of this assessment an articulated low-loader vehicle transporting a cable drum has been taken as the worst case scenario.



Access Point/Junction Design:

Two new access junctions will be designed. These are AP-I, located on Newbourne Road and AP-W, located on Holly Lane. Design of each new junction will take cognisance of the existing topography, existing vegetation, required visibility sightlines, and the minimum turning required to accommodate the low-loader vehicle.

A review of the previously installed access points used during the EA1 project will also be undertaken (AP-F, AP-G, AP-H, AP-X), along with the two areas where the proposed Haul Road will cross the public highway (CR1 & 2, and CR8 & 9).

1.3. Reference Documents

The findings of this report will be used as supplementary information to the following Scottish Power Renewables documents:

Table 1: Reference Documents

Document Reference	Title
EA3-LDC-CNS-REP-IBR-000023	Paper Mill Lane Commencement Works Access Management Plan
EA3-LDC-CNS-REP-IBR-000032	Paper Mill Lane Commencement Works Traffic Management Plan
EA3-LDC-CNS-REP-IBR-000036	Playford Commencement Works Access Management Plan
EA3-LDC-CNS-REP-IBR-000039	Playford Commencement Works Traffic Management Plan
EA3-LDC-CNS-REP-IBR-000050	Clappits Commencement Works Access Management Plan
EA3-LDC-CNS-REP-IBR-000053	Clappits Commencement Works Traffic Management Plan

2.0 Route Assessment

2.1. General Description

Three Access Routes have been assessed as part of this investigation. The location of each route is indicated on Figure 1, Section 1.1, and each route is described as follows:

1. From the roundabout at Junction 52 of the A14 to Access Points AP-F and AP-G.
2. From the junction of the B1079 & Woodbridge Rd to Access Points AP-X & AP-W
3. From the roundabout on the A12 at junction with Newbourne Road, to AP-H & AP-I

Each route provides access from the major road networks surrounding Ipswich, as identified on the Suffolk Lorry Route plan, to all access points required for the commencement cable works, based on the scope outlined in section 1.2 of this report.

2.2. Access to AP-F & AP-G (Paper Mill Lane)

Paper Mill Lane is accessed off the roundabout at junction 52 of the A14 Trunk Road. Access points AP-F & AP-G are around 530m south of the A14, along Paper Mill Lane.

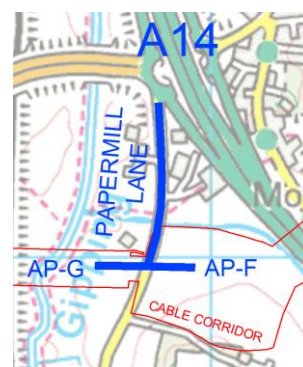

The width of carriageway on Paper Mill Lane is suitable for the majority of vehicles to pass each other safely, however there are also several passing places to assist with the passing of larger vehicles. No physical obstructions were noted during the survey which would prevent construction vehicles from reaching the access points.

Advance warning signage should be erected to warn/advise other road users of the presence of construction vehicles for the duration of the works.

Paper Mill Lane is currently subject to the National Speed Limit (60mph). Vehicle speed through the works area will therefore require to be reduced to 30mph, with the appropriate signage installed, and an application made to Suffolk County Council for a TTRO (Temporary Traffic Regulation Order).

No weight restrictions have been identified for this access route.

Table 2: Access to AP-F & AP-G Route Summary:

Question	Answer	Comments
Is access route suitable in width	YES	Route is supplemented with existing passing places
Any obstruction to prevent access	NO	No physical obstructions observed.
Are there any weight restrictions	NO	No weight restrictions identified.
Is advance warning signage required	YES	Install as per Drg No. 146103/1000
Is 30mph Speed restriction required	YES	Install as per Drg No. 146103/1000

2.3. Access to AP-W & AP-X

Access Point AP-W is located on Holly Lane. Access Point AP-X is located on an unnamed road near Playford Mount.

The access route to both AP-W & AP-X commences at the northern side of Grundisburgh, at the junction of Woodbridge Road and the B1079. All construction vehicles will proceed west along Woodbridge Road, which merges into The Street, then Rose Hill, then Ipswich Road towards Culpho Hall.

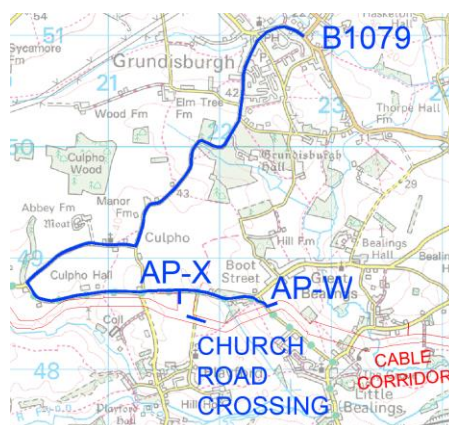

Access Point AP-X, which is located on the southern side of an unnamed road, is the first to be approached by construction vehicles using this route. Access Point AP-W will be reached by continuing east along the unnamed road to the first junction with Holly Lane. Holly lane has two junctions however the east most junction is not suitable for access and the western junction must be used. From the junction into Holly Lane, AP-W is around 170m further on and located to the east side of Holly Lane.

The route from the B1079 south to AP-X was used during the construction of the cable corridor as part of the EA1 project, with AP-X being referred to formerly as AX-08. Ten passing places were installed along this route as part of the EA1 project, and these have remained in place at the request of Suffolk County Council. Continuing on along the unnamed road towards Holly Lane and AP-W, the carriageway width would appear to be suitable for two way traffic. There are also several informal passing places which will assist during any construction traffic movements. However, given the rural nature of these roads, it is recommended that all abnormal load movements, including transport of the cable drum, are accompanied by a pilot/escort vehicle.

Ten locations along the route from the B1079 to AP-W have been identified where overhanging tree branches will impact on the transportation of the cable drum based on the use of a low-loader carrying a cable drum measuring 4.478m dia. Each location has been annotated on drawing number 146103/1010 (appendix 1), and scheduled Table 3 below:

Table 3: Grundisburgh Tree Survey

Tree Ref	Clear height to branches	Easting	Northing
GR-001	5.048m	622164.643	250217.530
GR-002	5.105m	622121.115	250136.692
GR-003	4.642m	621905.161	250032.894
GR-004	4.874m	621559.932	249559.654
GR-005	5.207m	621303.907	249278.577
GR-006	5.472m	621287.003	249223.463
GR-007	4.996m	620840.762	249114.734

GR-008	5.400m	621971.671	248633.448
GR-009	4.693m	622399.644	248568.431
GR-010	4.537m	622412.504	248547.329

The contractor should liaise with Suffolk County Council regarding trimming works to the tree locations noted above, and if required, obtain the necessary permissions to remove all branches which will impact on the cable drum transportation.

Advance warning signage should be erected to warn/advise other road users of the presence of construction vehicles for the duration of the works. Reference should be made to drawing numbers 146103/1001 and 146103/1003 (Appendix 1) associated with AP-X and AP-W.

The existing roads along the frontage of both AP-W and AP-X are currently subject to the National Speed Limit. Vehicle speed through the works area will therefore require to be reduced to 30mph, with the appropriate signage installed, and an application made to Suffolk County Council for a TTRO (Temporary Traffic Regulation Order). Speed restriction signage is indication on drawing numbers 146103/1001 and 146103/1003 (Appendix 1) associated with AP-X and AP-W.

No weight restrictions have been identified for this access route.

Table 4: Access to AP-W & AP-X Route Summary:

Question	Answer	Comments
Is access route suitable in width	YES	Route is supplemented with existing passing places
Any obstruction to prevent access	YES	Tree canopies will require trimming.
Are there any weight restrictions	NO	No weight restrictions identified.
Is advance warning signage required	YES	Install as per Drg No. 146103/1001 & 146103/1003
Is 30mph Speed restriction required	YES	Install as per Drg No. 146103/1001 & 146103/1003

2.4. Access to AP-H & AP-I

Access Points AP-H and AP-I are located on Newbourne Road. Access Point AP-H was used during the EA1 construction works, and has been partially reinstated and is now to be fully reinstated. AP-I is a new AFccess Point.

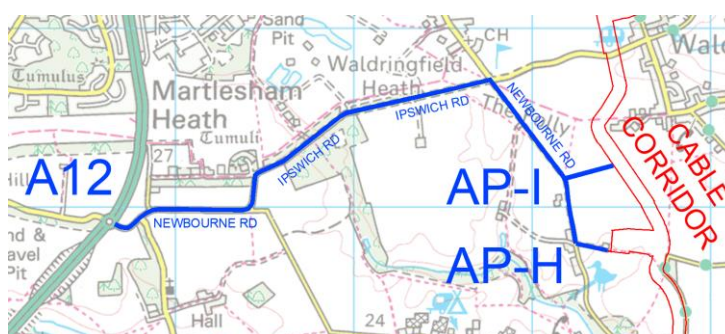

The access route to both AP-H & AP-I will commence at the A12 Roundabout, with construction traffic heading east along Newbourne Road for approximately 760m at which point the road sweeps left into Ipswich Road. Construction traffic will continue along Ipswich Road for approximately 1.7km taking the next junction with Newbourne Road, to the south. Travelling along Newbourne Road, AP-I is located approximately

690m to the south on the left hand side, with AP-H being a further 400m south, on the left hand side.

The route from the A12 east along Newbourne Road to AP-H was used for the construction of the cable corridor as part of the EA1 project, with AP-H formerly being referred to as AX-14. The first section of the route from the A12 roundabout, to the junction of Ipswich Road and Newbourne Road (1.46km) is suitable in width for two vehicles passing each other. There are also several informal passing places which will assist during any construction traffic movements. From the junction of Ipswich Road and Newbourne Road, the route south towards AP-H & AP-I was upgraded to provide passing places as part of the EA1 project and these have remained in place. Forward visibility is good throughout this access route. However, given the rural nature of these roads, it is recommended that all abnormal load movements, including transport of the cable drum, are accompanied by a pilot/escort vehicle.

Eleven locations along the route from the A12 Roundabout to AP-H have been identified where overhanging tree branches will impact on the transportation of the cable drum based on the use of a low-loader carrying a cable drum measuring 4.478m dia. Each location has been annotated on Drg No. 146103/1009 (appendix 1), and scheduled in Table 5 below:

Table 5: Newbourne Tree Survey

Tree Ref	Clear height to branches	Easting	Northing
NR-001	5.030m	624995.904	243961.979
NR-002	5.090m	625008.917	243961.959
NR-003	5.125m	625873.272	244440.355
NR-004	5.119m	625939.255	244495.424
NR-005	5.429m	626034.063	244523.986
NR-006	5.311m	626089.759	244537.138
NR-007	5.253m	626117.577	244543.562
NR-008	4.926m	626152.238	244551.566
NR-009	4.835m	626198.780	244562.264
NR-010	5.103m	626223.212	244567.772
NR-011	4.777m	626410.008	244610.381

The contractor should liaise with Suffolk County Council regarding trimming works to the tree locations noted above, and if required, obtain the necessary permissions to remove all branches which will impact on the cable drum transportation.

Advance warning signs should be erected to warn all road users of the presence of construction vehicles during the works. Reference should be made to drawing numbers 146103/1004 and 146103/1005 (Appendix 1) associated with AP-I and AP-H.

The existing roads along the frontage of both AP-H and AP-I are currently subject to the National Speed Limit. Vehicle speed through the works area will therefore require to be reduced to 30mph, with the appropriate signage installed, and an application made to Suffolk County Council for a TTRO (Temporary Traffic Regulation Order).

Speed restriction signage is indicated on drawing numbers 146103/1004 and 146103/1005 (Appendix 1) associated with AP-I and AP-H.

No weight restrictions have been identified for this access route.

Table 6: Access to AP-H & AP-I Route Summary:

Question	Answer	Comments
Is access route suitable in width	YES	Route is supplemented with existing passing places
Any obstruction to prevent access	YES	Tree canopies will require trimming.
Are there any weight restrictions	NO	No weight restrictions identified.
Is advance warning signage required	YES	Install as per Drg No. 146103/1004 & 146103/1005
Is 30mph Speed restriction required	YES	Install as per Drg No. 146103/1004 & 146103/1005

2.5. Overall Route Summary

Based on the findings of the route assessment, the only works which will be required in order to accommodate the abnormal load movement (Cable Drum), are trimming of tree canopies as noted in Tables 3 and 5.

The passing places which were constructed during the installation of the cable corridor associated with EA1 have been retained at the request of Suffolk County Council, and these will assist with the abnormal load movement in a similar way to EA1.

The use of a pilot/escort vehicle for all abnormal load movements is recommended.

3.0 Access Junction Design & Public Road Crossings

3.1. General Description

Six Access Junctions and Two public road crossings have been assessed as part of this investigation and are indicated on Figure 1, Section 1.1.

Each junction provides access from the local road network into the cable corridor for the required commencement works. In addition, two locations where the proposed cable corridor haul road crosses the public highway have been assessed. All based on the scope outlined in section 1.2 of this report.

3.2. AP-F & AP-G

Access Points AP-F and AP-G, were previously used for the construction of the cable corridor associated with the EA1 project. AP-F was previously designated as AX-05 with AP-G being designated as AX-04.

AX-04 (AP-G) was fully removed on completion of the EA1 project, with all verges and field reinstated.

AX-05 (AP-F) was partially removed. The filter/deceleration lane was removed and the junction radii reconfigured to tie in with the channel of Paper Mill Lane.

Both AX-04 and AX-05 (AP-g and AP-F) were previously approved by Suffolk County Council and also underwent a Stage 1/2 Road Safety Audit, along with a Stage 3 Road Safety Audit.

Due to the successful operation of the previously approved junctions, the proposal for this phase of works associated with EA3 is to simply reinstate each junction to the exact specification of those previously approved.

Refer to drawing number 146103/1000 for details (Appendix1).

3.3. AP-X

Access Point AP-X, was previously used for the construction of the cable corridor associated with the EA1 project. AP-X was previously designated as AX-08.

AX-08 (AP-X) was fully removed on completion of the EA1 project, with all verges and field reinstated.

AX-08 (AP-X) was previously approved by Suffolk County Council and also underwent a Stage 1/2 Road Safety Audit, along with a Stage 3 Road Safety Audit.

Due to the successful operation of the previously approved junction, the proposal for this phase of works associated with EA3 is to simply reinstate the junction to the exact specification of that previously approved.

Refer to drawing number 146103/1001 for details (Appendix1).

3.4. AP-W

AP-W is a proposed new access point, located to the east side of Holly Lane, and will provide access to cable corridor.

All new access junctions must take cognisance of the following design parameters:

- Junction radii designed to suit the requirements of an articulated low-loader.
- Allowance for sufficient length of hardstanding surface off the adjoining carriageway in order to prevent vehicles from blocking the public highway
- Designed with suitable junction visibility to suit the speed of the main road
- Junction to be within the width of the confines of the cable corridor.
- An access gate to be located across the end of the junction which opens in towards the cable corridor.

Vehicle swept path analysis has been undertaken to prove that an articulated low-loader HGV can access each junction, without the need to over-run and verges.

The extent of hard surfacing to the junction has been set back 20.0m from the eastern channel line of Holly Lane. This will allow the articulated low-loader, which is 17.918m in length, to sit fully off the public highway when the haul road access gates are closed, and not impact any other road users on Holly Lane.

Holly lane is currently subject to the National Speed Limit. However, Suffolk County Council has previously advised that all public roads, in the vicinity of any access points, should be reduced to 30mph. Accordingly, junction visibility splays should be set with an X-distance of 2.4m and a Y-distance of 90m, which would comply with the requirements of DMRB CD123 & CD109. However, if the compliant visibility splay is to be implemented, this would result in the loss of three mature trees as shown opposite. An alternative proposal has therefore been designed to minimise the loss of trees.



A system of temporary STOP/GO boards will be implemented for all vehicles exiting access AP-W. These will be installed and operated in strict accordance with the requirements of "The Traffic Signs Manual, Chapter 8, Part 1, Section D5.8" The use of the STOP/GO system will allow the minimal traffic on Holly Lane to be held at a suitable location on the public road whilst vehicles exit AP-W in a safe controlled manner. The STOP/GO system will be in addition to the advance warning signage. A Method Statement for the implementation and operation of the proposed STOP/GO system is included in Appendix 2.

Refer to drawing number 146103/1003 for details of AP-W (Appendix1).

3.5. AP-H

Access Point AP-H, was previously used for the construction of the cable corridor associated with the EA1 project. AP-H was previously designated as AX-14.

AX-14 (AP-H) was partially removed, with the access into Clapitts retained. The remainder of AX-14 was removed on completion of the EA1 project, with all verges and field reinstated with a Type 1 sub-base finish.

AX-14 (AP-H) was previously approved by Suffolk County Council and also underwent a Stage 1/2 Road Safety Audit, along with a Stage 3 Road Safety Audit.

Due to the successful operation of the previously approved junction, the proposal for this phase of works associated with EA3 is to install a new junction in exactly the same location as the previous EA1 access, albeit to a slightly reduced size to comply with the different Order Limits pertaining to EA3.

Refer to drawing number 146103/1005 for details (Appendix1).

3.6. AP-I

AP-I is a proposed new access point, located to the east side of Newbourne Road, which will provide access to the cable corridor. The location of AP-I replaces one of the passing places (HX-08-PP-05), which was constructed as part of the EA1 project.

All new access junctions must take cognisance of the following:

- Junction radii designed to suit the requirements of an articulated low-loader.
- Allowance for sufficient length of hardstanding surface off the adjoining carriageway in order to prevent vehicles from blocking the public highway
- Designed with suitable junction visibility to suit the speed of the main road
- Junction to be within the width of the confines of the cable corridor.
- An access gate to be located across the end of the junction which opens in towards the cable corridor.

In order to accommodate the turning manoeuvre into the junction, the junction radii have been set at 10.0m. This allows the articulated low-loader vehicle to turn into the junction without over-running any verges on Newbourne Road.

The extent of hard surfacing to the junction has been set back 20.0m from the eastern channel line of Holly Lane. This will allow the articulated low-loader, which is 17.918m in length, to sit fully off the public highway when the haul road access gates are closed, and not impact any other road users on Newbourne Road.

Newbourne is currently subject to the National Speed Limit. However, Suffolk County Council has previously advised that all public roads, in the vicinity of any access points, should be reduced to 30mph. Accordingly, junction visibility splays have been set with an X-distance of 2.4m and a Y-distance of 90m, which complies with the requirements of DMRB CD123 & CD109. The proposed junction fully complies with the visibility splay requirements with no vegetation clearance required.

Refer to drawing number 146103/1004 for details of AP-I (Appendix1).

3.7.

3.8. CR1 & 2

CR1 & CR2 will be used for continuity of the Haul Road where it crosses the public highway (The Street, Newbourne). Only construction traffic requiring to cross the road will be permitted to use the crossings. No construction traffic will be permitted to enter the crossing point via the public highway.

The crossing points each side of the public highway will consist of a 6.5m wide asphalt finished surface, which will extend a minimum of 20.0m beyond the channel line of the public highway.

Gates will be provided at the 20m set back, which will be manned at all times when construction traffic is using the crossing.

The safe working procedures for using public road crossing should be as follows:

- Open access gate on side of approach from haul road.
- Drive through access gate onto asphalt surfacing and stop before public road.
- Gate staff will operate stop/go boards on the public road when safe to do so.
- Vehicle will proceed across public road upon gate staff instructions.
- Vehicle to stop within asphalt surface on opposite side and ensure vehicle is fully off the public road.
- Access gates opened and proceed onto next section of haul road.
- All gates are to be securely closed to prevent public access.

Due to the operational procedures noted above, visibility splays are not considered to be relevant, however as an added safety measure, these have been included in the designs, with the requirements for vegetation clearance within the visibility splay noted.

Fairhurst has obtained the As-Built survey file for the previously design public road crossings installed by Roadbridge, on behalf of SPR, during the course of the EA1 project. The proposed arrangement has therefore been based on the crossing being established in the exact same location to that previously used for the EA1 works.

Refer to drawing number 146103/1006 for details of AP-I (Appendix1).

3.9. Haul Road Crossing at Church Road

The crossing of Church Road will be used to provide continuity of the Haul Road, and will only be used for the crossing of construction traffic. No construction traffic will be permitted to enter the crossing point via the public highway.

The crossing points each side of the public highway will consist of a 6.5m wide asphalt finished surface, which will extend a minimum of 20.0m beyond the channel line of the public highway.

Gates will be provided at the 20m set back, which will be manned at all times when construction traffic is using the crossing.

The safe working procedures for using public road crossing will be as per 3.7.

Due to the operational procedures noted above, visibility splays are not considered to be relevant, however as an added safety measure, these have been included in the designs, with the requirements for vegetation clearance within the visibility splay noted.

Fairhurst has obtained the As-Built survey file for the previously design public road crossings installed by Roadbridge, on behalf of SPR, during the course of the EA1 project. The proposed arrangement has therefore been based on the crossing being established in the exact same location to that previously used for the EA1 works.

Refer to drawing number 146103/1002 for details of the Church Road Crossing (Appendix1).

4.0 Existing Services

4.1. Electrical and Telecom Services

During the site survey works, overhead electrical cables and telecom cables, which cross the public highway, were observed in numerous locations. No survey information was obtained as to the height of each service cable, as this would have required specialist non-contact measuring devices.

Published guidance notes indicate that overhead power lines should be at a minimum clearance from the ground of 5.8 metres where they cross public roads. Telecom Cables can vary in height from 4m to 7m.



The potential for existing overhead services to clash with any abnormal load movement along the public roads will require to be assessed and confirmed using specialist non-contact survey equipment, with all works taking full cognisance of the requirements of GSE Guidance Note GS6 (Fourth Edition).

Woodbridge Road **Grundisburgh**



APPENDIX 1

DRAWINGS:

Drawing No.	Title:
146103-1000	ACCESS POINT AP=F & AP-G JUNCTION LAYOUT AND LOCATION PLAN
146103-1001	ACCESS POINT AP-X JUNCTION LAYOUT AND LOCATION PLAN
146103-1002	PUBLIC ROAD CROSSING, CHURCH ROAD, LOCATION PLAN AND DETAILS
146103-1003	ACCESS POINT AP-W JUNCTION LAYOUT AND LOCATION PLAN
146103-1004	ACCESS POINT AP-I JUNCTION LAYOUT AND LOCATION PLAN
146103-1005	ACCESS POINT AP-H JUNCTION LAYOUT AND LOCATION PLAN
146103-1006	PUBLIC ROAD CROSSING, CR1 & CR2, THE STREET, LOCATION PLAN AND DETAILS
146103-1007	ROAD CONSTRUCTION DETAILS
146103-1008	ROAD SIGNAGE
146103-1009	NEWBOURNE ROAD ACCESS ROUTE TO AP-H AND AP-I
146103-1010	GRUNDISBURGH ROAD ACCESS ROUTE TO AP-X AND AP-W
146103-1011	A14 TO PAPER MILL LANE ROAD ACCESS ROUTE TO AP-F AND AP-G
146103-1012	ACCESS POINT AP-AF AND AP-AG SWEPT PATH
146103-1013	ACCESS POINT AP-X SWEPT PATH
146103-1014	ACCESS POINT AP-W SWEPT PATH
146103-1015	ACCESS POINT AP-I SWEPT PATH
146103-1016	ACCESS POINT AP-H SWEPT PATH

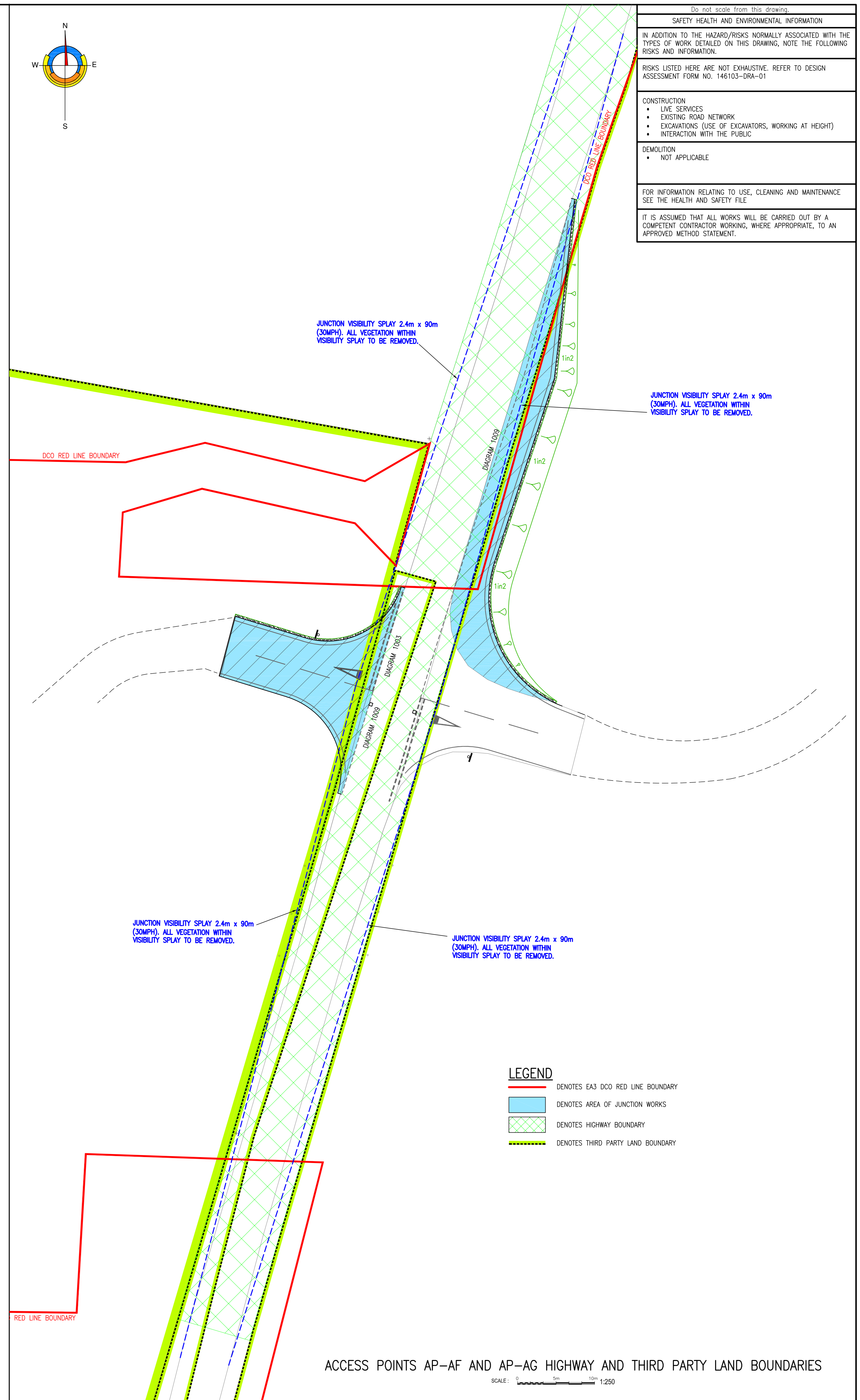
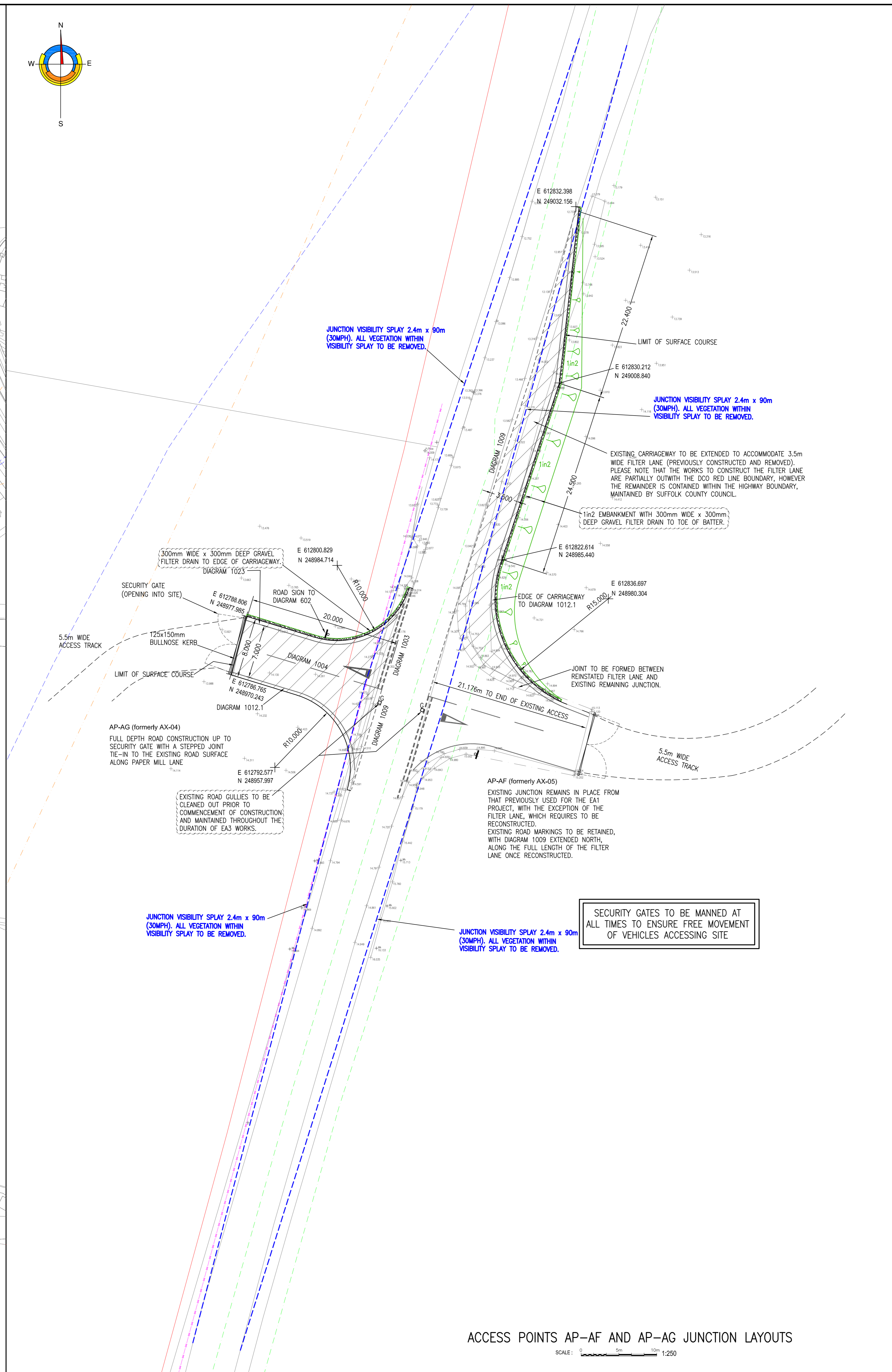
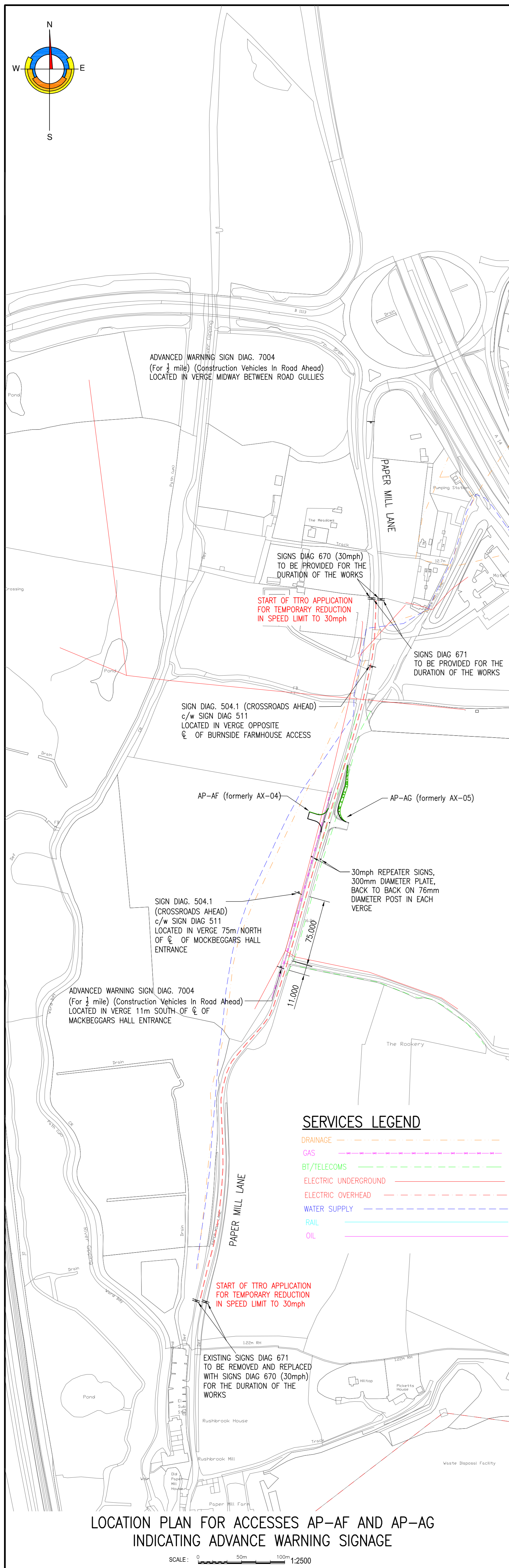

Do not scale from this drawing.

SAFETY HEALTH AND ENVIRONMENTAL INFORMATION

IN ADDITION TO THE HAZARD/RISKS NORMALLY ASSOCIATED WITH THE TYPES OF WORK DETAILED ON THIS DRAWING, NOTE THE FOLLOWING RISKS AND INFORMATION:

RISKS LISTED HERE ARE NOT EXHAUSTIVE. REFER TO DESIGN ASSESSMENT FORM NO. 146103-DRA-01

CONSTRUCTION

- LIVE SERVICES
- EXISTING ROAD NETWORK
- EXCAVATIONS (USE OF EXCAVATORS, WORKING AT HEIGHT)
- INTERACTION WITH THE PUBLIC

DEMOLITION

- NOT APPLICABLE

FOR INFORMATION RELATING TO USE, CLEANING AND MAINTENANCE SEE THE HEALTH AND SAFETY FILE

IT IS ASSUMED THAT ALL WORKS WILL BE CARRIED OUT BY A COMPETENT CONTRACTOR WORKING, WHERE APPROPRIATE, TO AN APPROVED METHOD STATEMENT.

Rev.	Date	Description	Drawn	Checked	Approved
F	15.04.22	EXTENTS OF VISIBILITY SPLAYS NOW SHOWN. NOTES REGARDING EXISTING GULLIES AND NEW FILTER DRAINS ADDED. ALL SHOWN CLOUDED.	ACM	GAV	GAV
E	06.04.22	FILTER STRIP ADDED TO TOE OF EMBANKMENT AT FILTER LANE. 30mph REPEATER SIGNS ADDED.	SC	GAV	GAV
D	24.03.22	GENERAL UPDATE FOLLOWING COMMENTS FROM CLIENT AND SCC.	ACM	GAV	GAV
C	18.03.22	UPDATED TO SHOW NKT ACCESS TRACK ALIGNMENT SWEEP PATHS REMOVED. REFER TO DRG 146103/1012 FOR DETAILS.	ACM	GAV	GAV
B	11.03.22	JUNCTION VISIBILITY SPLAYS UPDATED TO BE 2.4m x 90m HIGHWAY AND THIRD PARTY LAND BOUNDARY PLAN ADDED.	ACM	GAV	GAV
A	20.12.21	DCO RED BOUNDARY LINE ADDED TO JUNCTION LAYOUT DETAIL.	ACM	GAV	GAV

Notes

- THIS DRAWING IS TO BE READ IN CONJUNCTION WITH ALL RELEVANT DRAWINGS AND SPECIFICATIONS.
- ALL WORKS ARE TO BE CARRIED OUT IN ACCORDANCE WITH 'THE SPECIFICATION FOR HIGHWAY WORKS'.
- FOR ROAD CONSTRUCTION DETAILS AND NOTES, REFER TO DRAWING No. 146103/1007.
- FOR ROAD SIGNAGE DETAILS AND NOTES REFER TO DRAWING No. 146103/1008.
- PROPOSED SIGN LOCATIONS SHOWN ARE INDICATIVE ONLY. FINAL POSITIONS TO BE ESTABLISHED ON SITE IN CONJUNCTION WITH SUFFOLK COUNTY COUNCIL.
- REGULAR SIGNAGE INSPECTIONS AND MAINTENANCE TO BE CARRIED OUT, FOR THE DURATION OF THE WORKS, TO AVOID POSSIBLE OBSTRUCTION BY SEASONAL VEGETATION GROWTH.
- FOR SWEEP PATH ANALYSIS PLEASE REFER TO DRAWING 146103/1012

Project Title: EA3 HVDC ROUTE PRE-COMMENCEMENT WORKS TRANSPORT ASSESSMENT		Drawing Title: ACCESS POINTS AP-F AND AP-G JUNCTION LAYOUTS AND LOCATION PLAN	
Date: 12/11/21	Date: 12/11/21	Date: 12/11/21	Date: 12/11/21
Drawing No.: 146103/1000		Project No.: F	

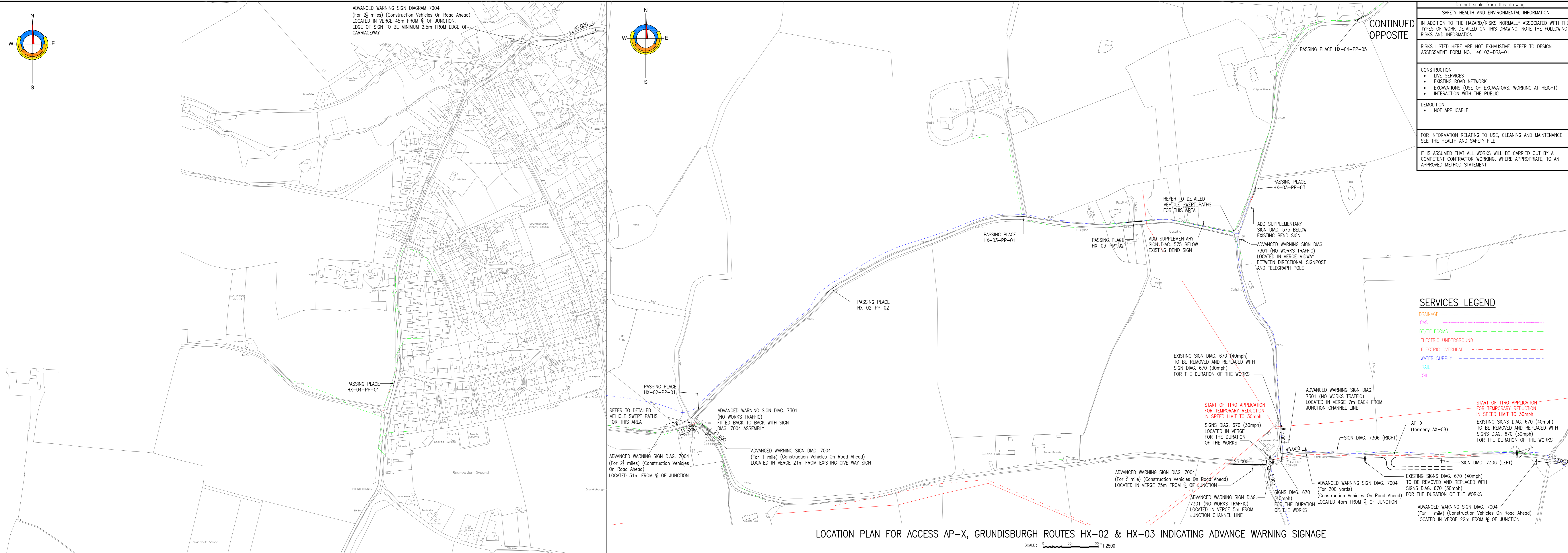

Do not scale from this drawing.

SAFETY HEALTH AND ENVIRONMENTAL INFORMATION

IN ADDITION TO THE HAZARD/RISKS NORMALLY ASSOCIATED WITH THE TYPES OF WORK DETAILED ON THIS DRAWING, NOTE THE FOLLOWING RISKS AND INFORMATION.

RISKS LISTED HERE ARE NOT EXHAUSTIVE. REFER TO DESIGN ASSESSMENT FORM NO. 146103-01A-01

CONSTRUCTION

- LIVE SERVICES
- EXISTING ROAD NETWORK
- EXCAVATIONS (USE OF EXCAVATORS, WORKING AT HEIGHT)
- INTERACTION WITH THE PUBLIC

DEMOLITION

- NOT APPLICABLE

FOR INFORMATION RELATING TO USE, CLEANING AND MAINTENANCE SEE THE HEALTH AND SAFETY FILE

IT IS ASSUMED THAT ALL WORKS WILL BE CARRIED OUT BY AN COMPETENT CONTRACTOR WORKING, WHERE APPROPRIATE, TO AN APPROVED METHOD STATEMENT.

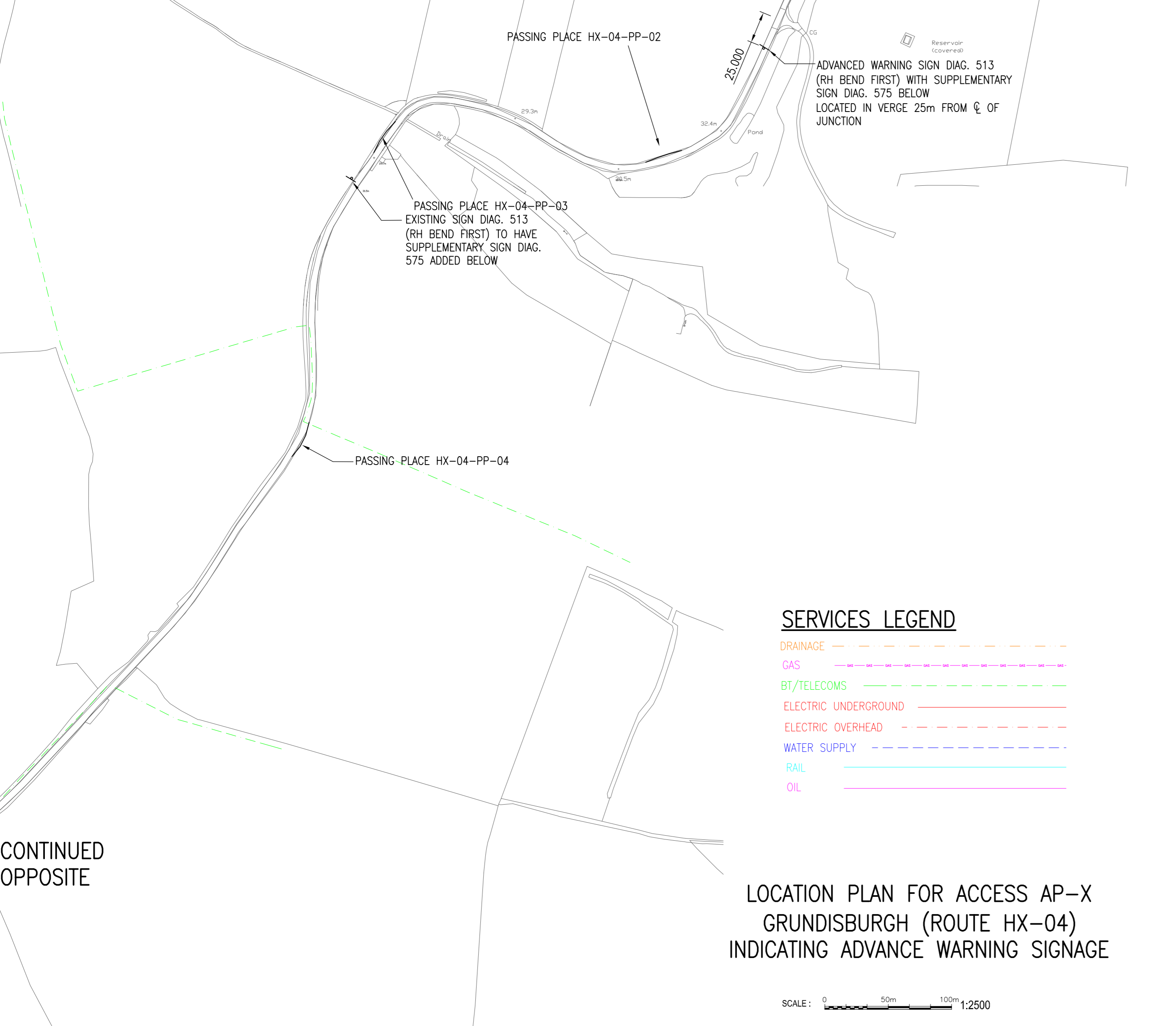
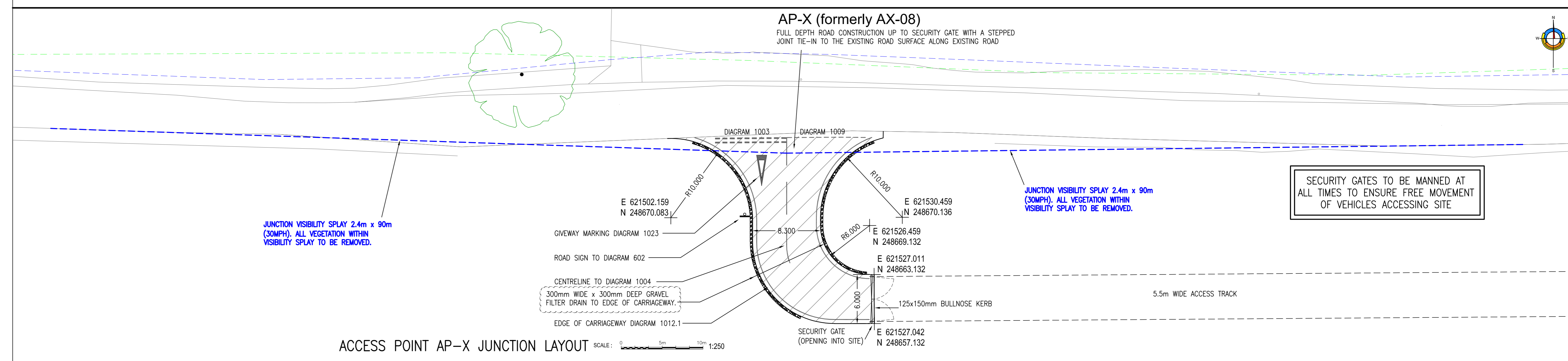
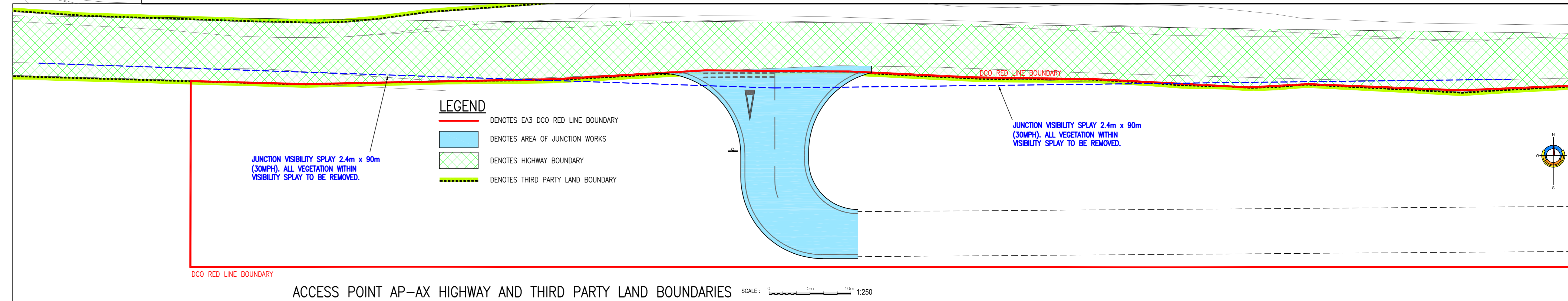
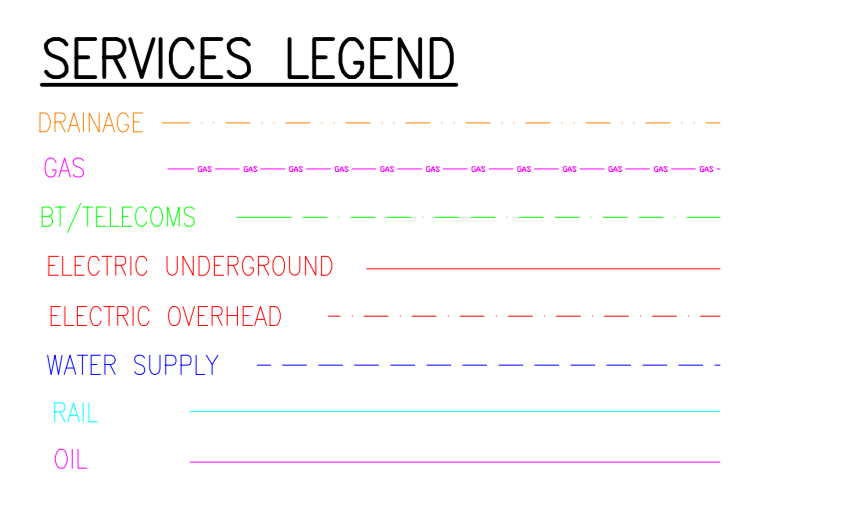

Rev.	Date	Description	Drawn	Checked	Approved
F	15.04.22	EXTENTS OF VISIBILITY SPLAYS NOW SHOWN. NOTES REGARDING NEW FILTER DRAINS ADDED. ALL SHOWN CLOUDED.	ACM	GAV	GAV
E	06.04.22	FILTER STRIP ADDED TO OUTER EDGE OF JUNCTION.	SC	GAV	GAV
D	24.03.22	GENERAL UPDATE FOLLOWING COMMENTS FROM CLIENT AND SOC.	ACM	GAV	GAV
C	18.03.22	UPDATED TO SHOW NKT ACCESS TRACK ALIGNMENT SWEEP PATHS REMOVED. REFER TO DRG 146103/1013 FOR DETAILS	ACM	GAV	GAV
B	11.03.22	JUNCTION VISIBILITY SPLAYS UPDATED TO BE 2.4m x 90m HIGHWAY AND THIRD PARTY LAND BOUNDARY PLAN ADDED.	ACM	GAV	GAV
A	20.12.21	DCO RED BOUNDARY LINE ADDED TO JUNCTION LAYOUT DETAIL.	ACM	GAV	GAV

- Notes:
- THIS DRAWING IS TO BE READ IN CONJUNCTION WITH ALL RELEVANT DRAWINGS AND SPECIFICATIONS.
 - ALL WORKS ARE TO BE CARRIED OUT IN ACCORDANCE WITH 'THE SPECIFICATION FOR HIGHWAY WORKS'.
 - FOR ROAD CONSTRUCTION DETAILS AND NOTES, REFER TO DRAWING NO. 146103/1007.
 - FOR ROAD SIGNAGE DETAILS AND NOTES REFER TO DRAWING NO. 146103/1008.
 - PROPOSED SIGN LOCATIONS SHOWN ARE INDICATIVE ONLY. FINAL POSITIONS TO BE ESTABLISHED ON SITE IN CONJUNCTION WITH SUFFOLK COUNTY COUNCIL.
 - REGULAR SIGNAGE INSPECTIONS AND MAINTENANCE TO BE CARRIED OUT, FOR THE DURATION OF THE WORKS, TO AVOID POSSIBLE OBSTRUCTION BY SEASONAL VEGETATION GROWTH.
 - FOR SWEEP PATH ANALYSIS PLEASE REFER TO DRAWING 146103/1013

Project Title: **EA3 HVDC ROUTE PRE-COMMENCEMENT WORKS TRANSPORT ASSESSMENT**

Client: **NKT**

Contractor: **SCOTTISHPOWER RENEWABLES**

Project No: **146103/1001**

Sheet No: **F**

Revision History:

Rev.	Date	Description	Drawn	Checked	Approved
1	12/11/21				
2	11/11/21				
3	11/11/21				

FAIRHURST

Southampton Road, SURREY, GU4 7JH
Tel: 01882 453300 Fax: 0844 281 4412

Author: [Name] Date: [Date]
AS SHOWN FOR APPROVAL

Drawn: [Name] Date: [Date]
Checked: [Name] Date: [Date]
Approved: [Name] Date: [Date]

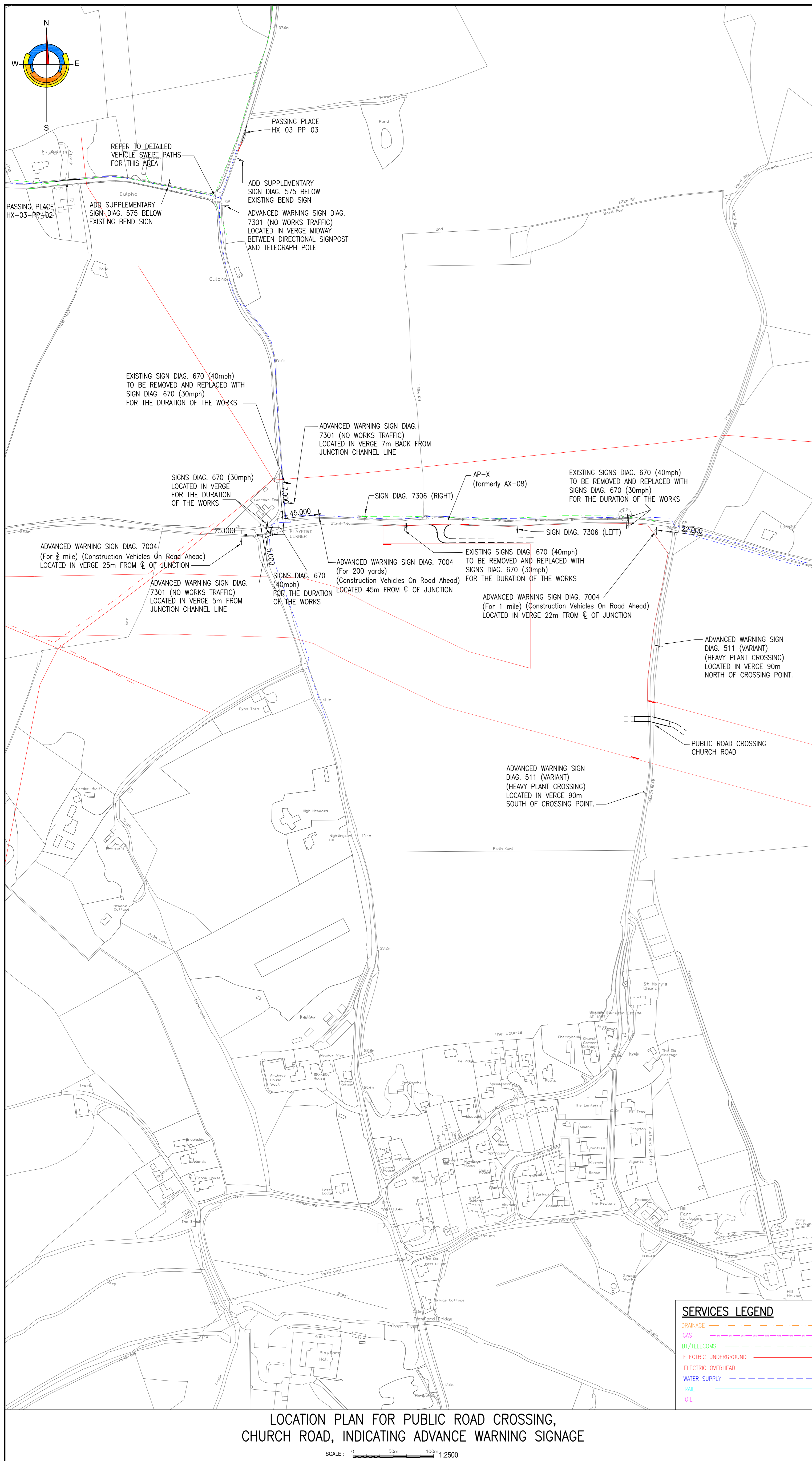

SCALE: 0 10m 20m 1:2500

SERVICES LEGEND

- GAS
- BT/TELECOMS
- ELECTRIC UNDERGROUND
- ELECTRIC OVERHEAD
- WATER SUPPLY
- FIBRE
- OIL

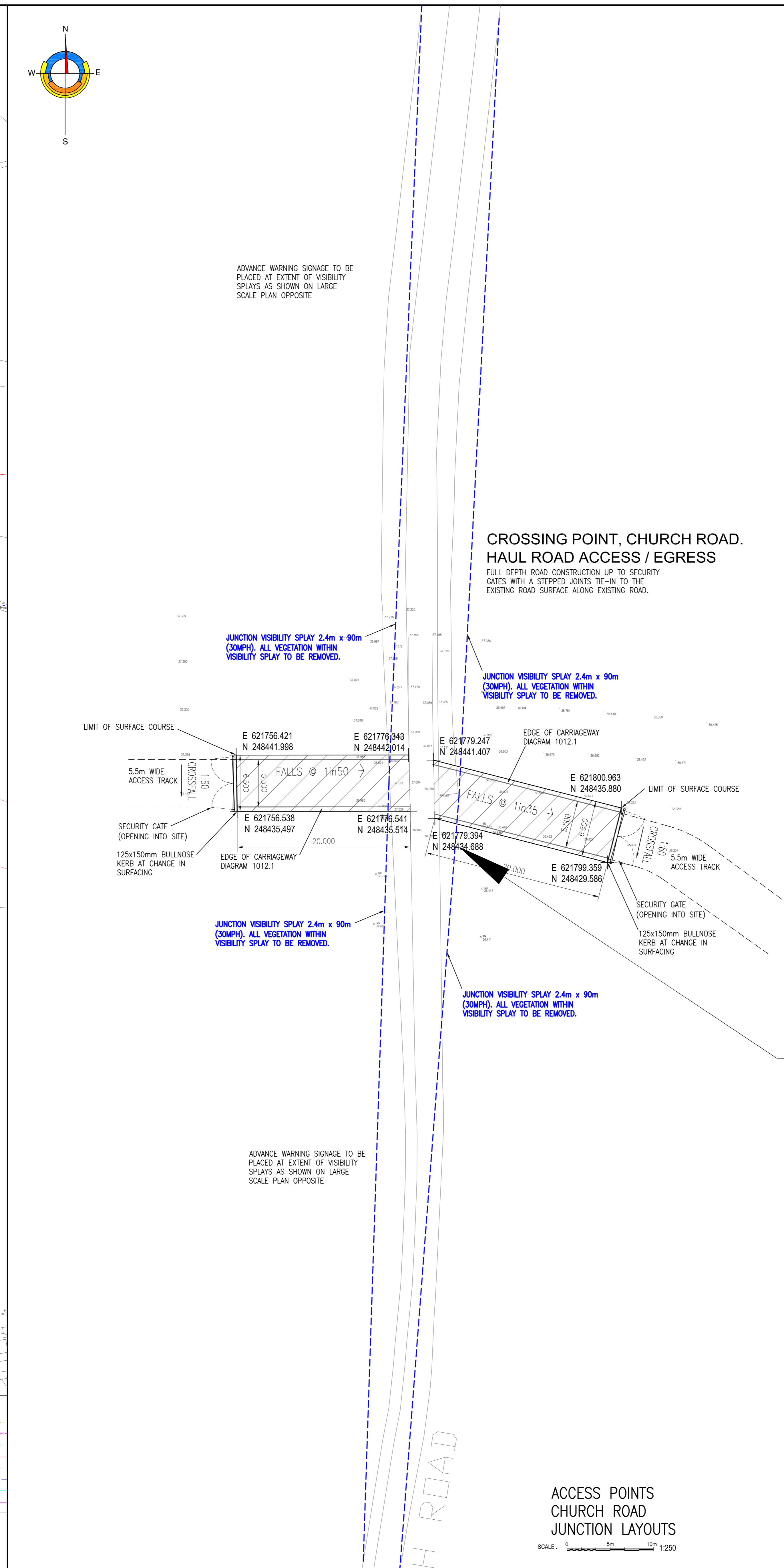

CROSSING POINT, CHURCH ROAD. HAUL ROAD ACCESS / EGRESS

FULL DEPTH ROAD CONSTRUCTION UP TO SECURITY GATES WITH A STEPPED JOINTS TIE-IN TO THE EXISTING ROAD SURFACE ALONG EXISTING ROAD.

ACCESS POINTS CHURCH ROAD JUNCTION LAYOUTS

SCALE: 0 5m 10m 1:250

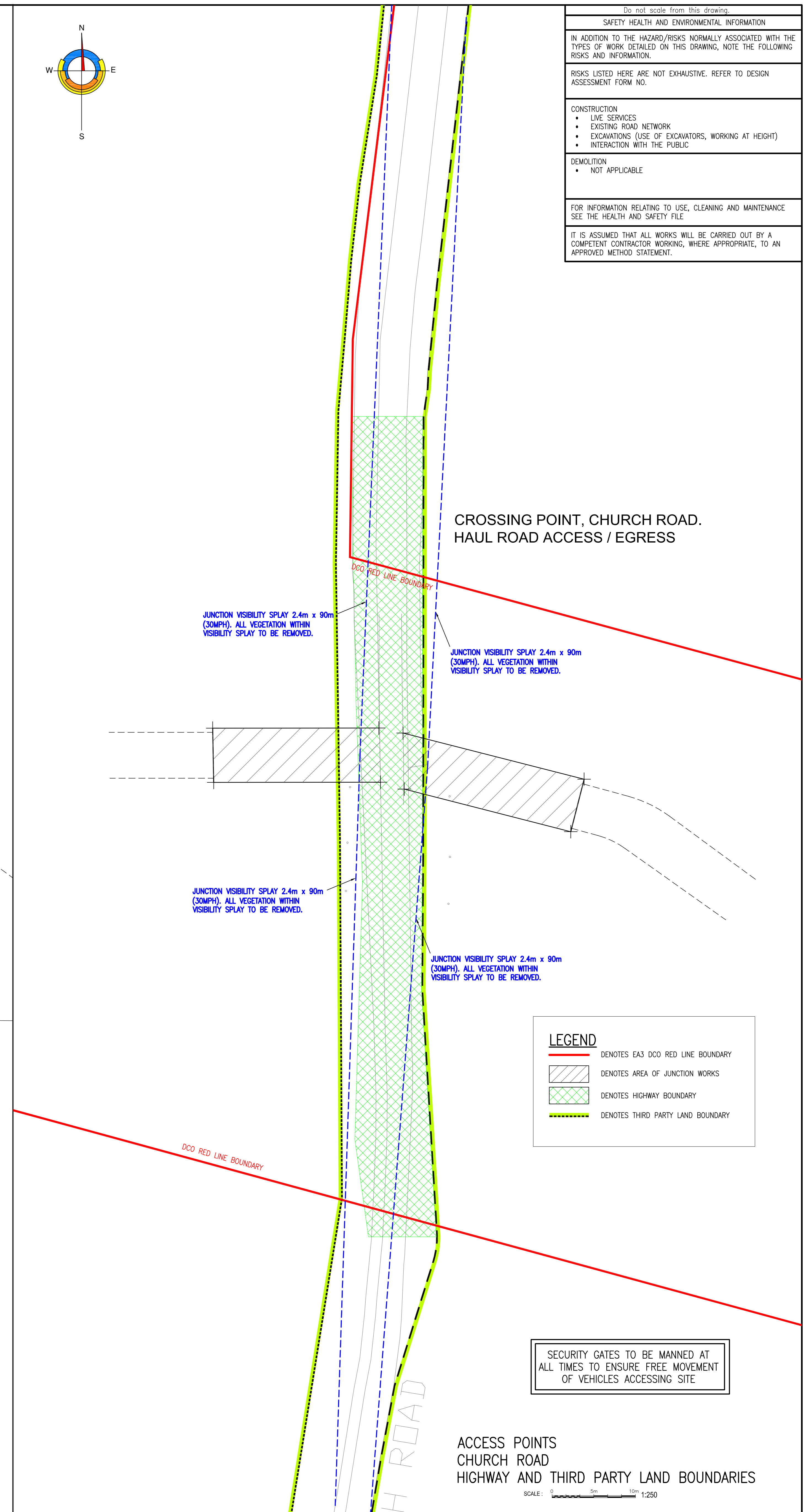

CROSSING POINT, CHURCH ROAD. HAUL ROAD ACCESS / EGRESS

FULL DEPTH ROAD CONSTRUCTION UP TO SECURITY GATES WITH A STEPPED JOINTS TIE-IN TO THE EXISTING ROAD SURFACE ALONG EXISTING ROAD.

LEGEND

- DENOTES EA3 DCO RED LINE BOUNDARY
- DENOTES AREA OF JUNCTION WORKS
- DENOTES HIGHWAY BOUNDARY
- DENOTES THIRD PARTY LAND BOUNDARY

SECURITY GATES TO BE MANNED AT ALL TIMES TO ENSURE FREE MOVEMENT OF VEHICLES ACCESSING SITE

ACCESS POINTS CHURCH ROAD HIGHWAY AND THIRD PARTY LAND BOUNDARIES

SCALE: 0 5m 10m 1:250

Rev.	Date	Description	Drawn	Checked	Approved
D	25.04.22	UPDATED TO SHOW FULL EXTENTS OF VISIBILITY SPLAYS.	ACM	GAV	GAV
C	18.03.22	UPDATED TO SHOW NKT ACCESS TRACK ALIGNMENT	ACM	GAV	GAV
B	11.03.22	JUNCTION VISIBILITY SPLAYS ADDED (2.4m x 90m)	ACM	GAV	GAV
A	20.12.21	DCO RED BOUNDARY LINE ADDED TO JUNCTION LAYOUT DETAIL.	ACM	GAV	GAV

- Notes:
- THIS DRAWING IS TO BE READ IN CONJUNCTION WITH ALL RELEVANT DRAWINGS AND SPECIFICATIONS.
 - ALL WORKS ARE TO BE CARRIED OUT IN ACCORDANCE WITH 'THE SPECIFICATION FOR HIGHWAY WORKS'.
 - FOR ROAD CONSTRUCTION DETAILS AND NOTES, REFER TO DRAWING No. 146103/1007.
 - FOR ROAD SIGNAGE DETAILS AND NOTES REFER TO DRAWING No. 146103/1008.
 - PROPOSED SIGN LOCATIONS SHOWN ARE INDICATIVE ONLY. FINAL POSITIONS TO BE ESTABLISHED ON SITE IN CONJUNCTION WITH SUFFOLK COUNTY COUNCIL.
 - REGULAR SIGNAGE INSPECTIONS AND MAINTENANCE TO BE CARRIED OUT, FOR THE DURATION OF THE WORKS, TO AVOID POSSIBLE OBSTRUCTION BY SEASONAL VEGETATION GROWTH.

		EA3 HVDC ROUTE PRE-COMMENCEMENT WORKS TRANSPORT ASSESSMENT	
	Project Title: PUBLIC ROAD CROSSING CHURCH ROAD JUNCTION LAYOUTS AND LOCATION PLAN	Drawing No: 146103/1002	Date: 17/03/2022

Do not scale from this drawing.

SAFETY HEALTH AND ENVIRONMENTAL INFORMATION

IN ADDITION TO THE HAZARD/RISKS NORMALLY ASSOCIATED WITH THE TYPES OF WORK DETAILED ON THIS DRAWING, NOTE THE FOLLOWING RISKS AND INFORMATION.

RISKS LISTED HERE ARE NOT EXHAUSTIVE. REFER TO DESIGN ASSESSMENT FORM NO.

CONSTRUCTION

- LIVE SERVICES
- EXISTING ROAD NETWORK
- EXCAVATIONS (USE OF EXCAVATORS, WORKING AT HEIGHT)
- INTERACTION WITH THE PUBLIC

DEMOLITION

- NOT APPLICABLE

FOR INFORMATION RELATING TO USE, CLEANING AND MAINTENANCE SEE THE HEALTH AND SAFETY FILE

IT IS ASSUMED THAT ALL WORKS WILL BE CARRIED OUT BY A COMPETENT CONTRACTOR WORKING, WHERE APPROPRIATE, TO AN APPROVED METHOD STATEMENT

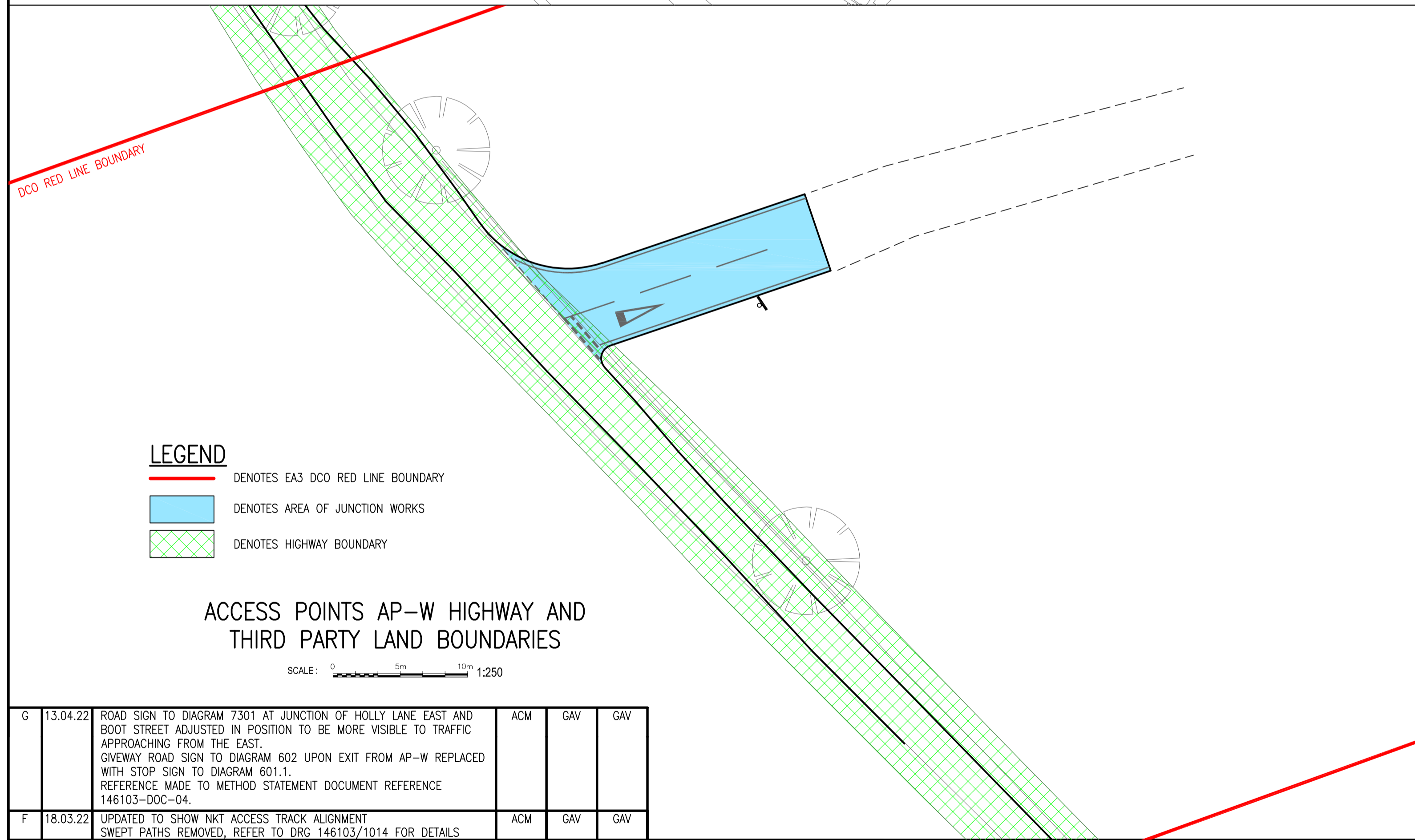
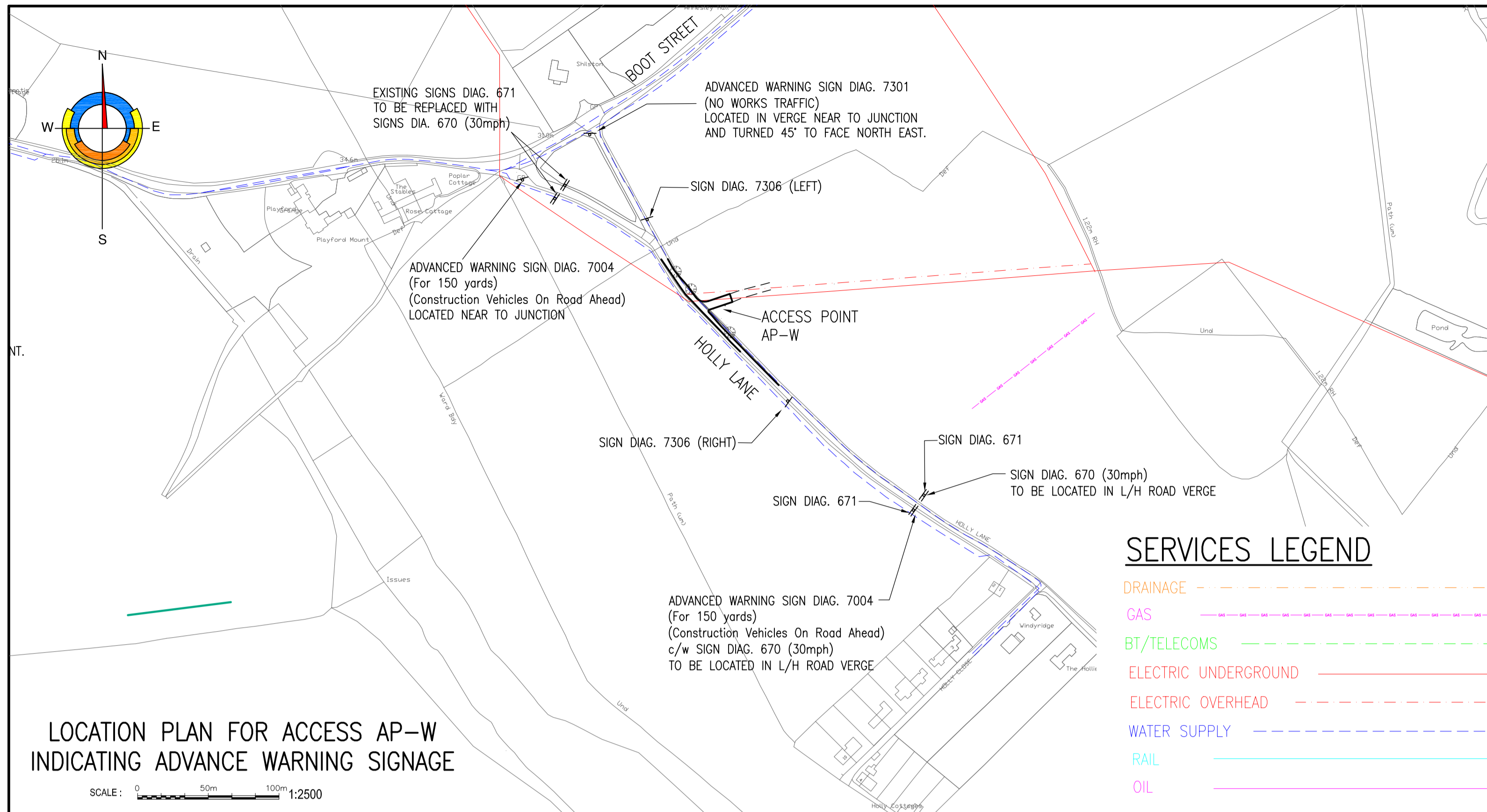

Rev.	Date	Description	Drawn	Checked	Approved
G	13.04.22	ROAD SIGN TO DIAGRAM 7301 AT JUNCTION OF HOLLY LANE EAST AND BOOT STREET ADJUSTED IN POSITION TO BE MORE VISIBLE TO TRAFFIC APPROACHING FROM THE EAST. GIVEWAY ROAD SIGN TO DIAGRAM 602 UPON EXIT FROM AP-W REPLACED WITH STOP SIGN TO DIAGRAM 601.1. REFERENCE MADE TO METHOD STATEMENT DOCUMENT REFERENCE 146103-DOC-04.	ACM	GAV	GAV
F	18.03.22	UPDATED TO SHOW NKT ACCESS TRACK ALIGNMENT SWEEP PATHS REMOVED. REFER TO DRG 146103/1014 FOR DETAILS	ACM	GAV	GAV
E	11.03.22	JUNCTION VISIBILITY SPLAYS ADDED (2.4m x 90m) HIGHWAY BOUNDARY INFORMATION ADDED	ACM	GAV	GAV
D	06.01.22	JUNCTION ARRANGEMENT UPDATED TO MINIMISE IMPACT OF EXISTING TREE IMMEDIATELY NORTH OF JUNCTION FOLLOWING RECEIPT OF ARBORICULTURAL REPORT BY BOWLAND TREE CONSULTANCY LTD.	ACM	GAV	GAV
C	20.12.21	DCO RED BOUNDARY LINE ADDED TO JUNCTION LAYOUT DETAIL. TRAFFIC SIGN TO Dia. 7301 REMOVED FROM NO ENTRY LIMB OF NORTHBOUND CHURCH LANE AS PER SCC EMAIL DATED 13/12/2021	ACM	GAV	GAV
B	19.11.21	TO SUIT THE REQUIREMENTS TO RETAIN THE EXISTING MATURE TREES, WHICH SIGNIFICANTLY IMPACT ON THE AVAILABLE JUNCTION VISIBILITY. CHAPTER 8 COMPLIANT STOP/GO BOARDS HAVE BEEN PROPOSED AS ADDITIONAL SAFETY MEASURES.	ACM	GAV	GAV
A	12.11.21	ADDITIONAL SIGNS DIAG. 7301 ADDED TO HOLLY LANE EAST, FACING NORTHBOUND TRAFFIC. DESIGN PHILOSOPHY FOR JUNCTION UPDATED.	ACM	GAV	GAV

- Notes:
- THIS DRAWING IS TO BE READ IN CONJUNCTION WITH ALL RELEVANT DRAWINGS AND SPECIFICATIONS.
 - ALL WORKS ARE TO BE CARRIED OUT IN ACCORDANCE WITH 'THE SPECIFICATION FOR HIGHWAY WORKS'.
 - FOR ROAD CONSTRUCTION DETAILS AND NOTES, REFER TO DRAWING No. 146103/1007.
 - FOR ROAD SIGNAGE DETAILS AND NOTES REFER TO DRAWING No. 146103/1008.
 - PROPOSED SIGN LOCATIONS SHOWN ARE INDICATIVE ONLY. FINAL POSITIONS TO BE ESTABLISHED ON SITE IN CONJUNCTION WITH SUFFOLK COUNTY COUNCIL.
 - REGULAR SIGNAGE INSPECTIONS AND MAINTENANCE TO BE CARRIED OUT, FOR THE DURATION OF THE WORKS, TO AVOID POSSIBLE OBSTRUCTION BY SEASONAL VEGETATION GROWTH.
 - FOR SWEEP PATH ANALYSIS PLEASE REFER TO DRAWING 146103/1014

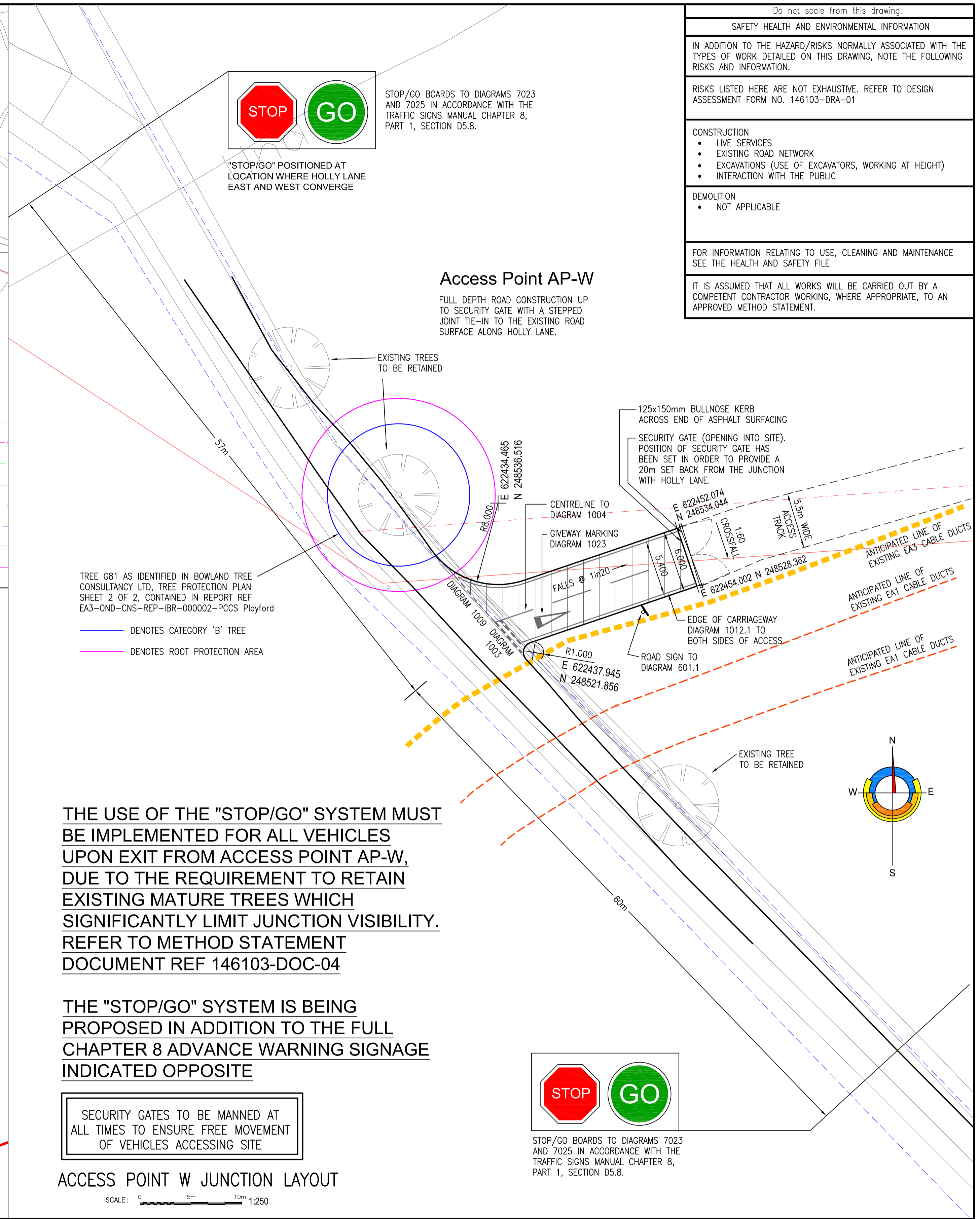

THE USE OF THE "STOP/GO" SYSTEM MUST BE IMPLEMENTED FOR ALL VEHICLES UPON EXIT FROM ACCESS POINT AP-W, DUE TO THE REQUIREMENT TO RETAIN EXISTING MATURE TREES WHICH SIGNIFICANTLY LIMIT JUNCTION VISIBILITY. REFER TO METHOD STATEMENT DOCUMENT REF 146103-DOC-04

THE "STOP/GO" SYSTEM IS BEING PROPOSED IN ADDITION TO THE FULL CHAPTER 8 ADVANCE WARNING SIGNAGE INDICATED OPPOSITE

SECURITY GATES TO BE MANNED AT ALL TIMES TO ENSURE FREE MOVEMENT OF VEHICLES ACCESSING SITE

ACCESS POINT W JUNCTION LAYOUT

Do not scale from this drawing.

SAFETY HEALTH AND ENVIRONMENTAL INFORMATION

IN ADDITION TO THE HAZARD/RISKS NORMALLY ASSOCIATED WITH THE TYPES OF WORK DETAILED ON THIS DRAWING, NOTE THE FOLLOWING RISKS AND INFORMATION:

RISKS LISTED HERE ARE NOT EXHAUSTIVE. REFER TO DESIGN ASSESSMENT FORM NO. 146103-DRA-01

CONSTRUCTION

- LIVE SERVICES
- EXISTING ROAD NETWORK
- EXCAVATIONS (USE OF EXCAVATORS, WORKING AT HEIGHT)
- INTERACTION WITH THE PUBLIC

DEMOLITION

- NOT APPLICABLE

FOR INFORMATION RELATING TO USE, CLEANING AND MAINTENANCE SEE THE HEALTH AND SAFETY FILE

IT IS ASSUMED THAT ALL WORKS WILL BE CARRIED OUT BY A COMPETENT CONTRACTOR WORKING, WHERE APPROPRIATE, TO AN APPROVED METHOD STATEMENT.

	Client:	EA3 HVDC ROUTE PRE-COMMENCEMENT WORKS TRANSPORT ASSESSMENT	
		Project Title:	
Scale at A1: AS SHOWN		Status: FOR APPROVAL	Drawing No.: 146103/1003
Drawn: ACM		Checked: GAV	Approved: GAV
Date: 09/11/21		Date: 09/11/21	Date: 09/11/21
Rev.		Description	Revision: G

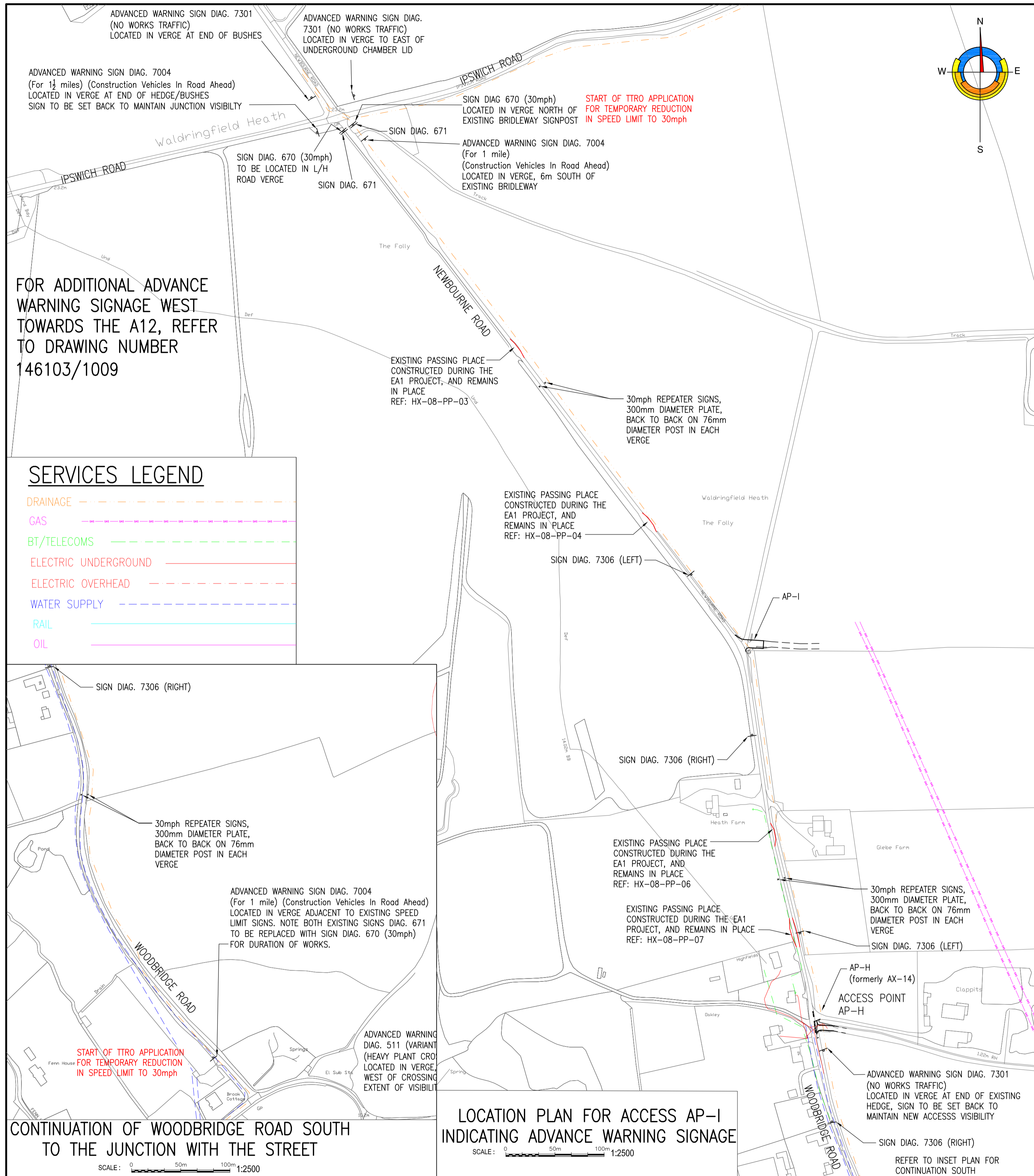

FOR ADDITIONAL ADVANCE WARNING SIGNAGE WEST TOWARDS THE A12, REFER TO DRAWING NUMBER 146103/1009

SERVICES LEGEND	
DRAINAGE	---
GAS	---
BT/TELECOMS	---
ELECTRIC UNDERGROUND	---
ELECTRIC OVERHEAD	---
WATER SUPPLY	---
RAIL	---
OIL	---

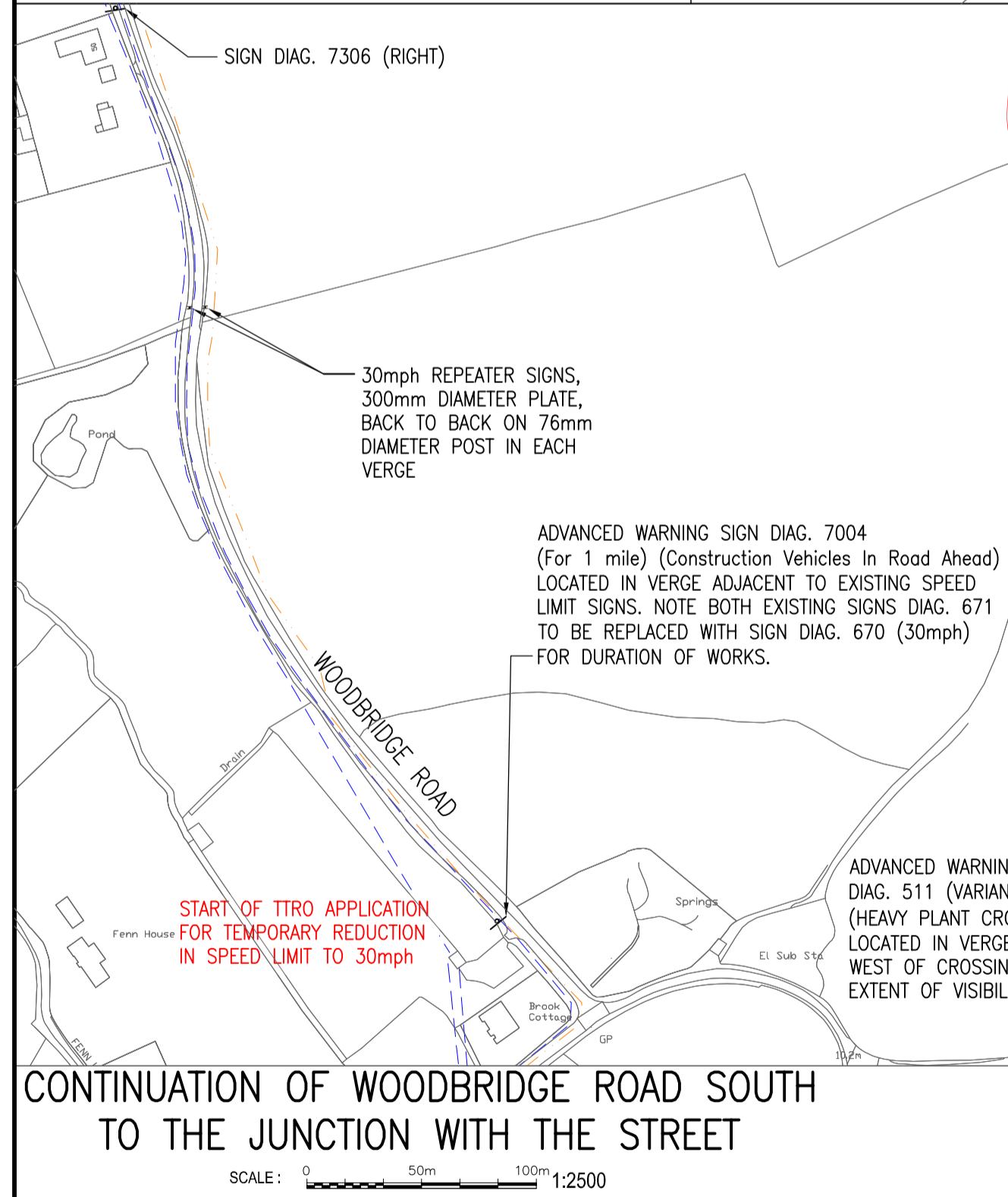

CONTINUATION OF WOODBRIDGE ROAD SOUTH TO THE JUNCTION WITH THE STREET
SCALE: 0 50m 100m 1:2500

LOCATION PLAN FOR ACCESS AP-I INDICATING ADVANCE WARNING SIGNAGE
SCALE: 0 50m 100m 1:2500

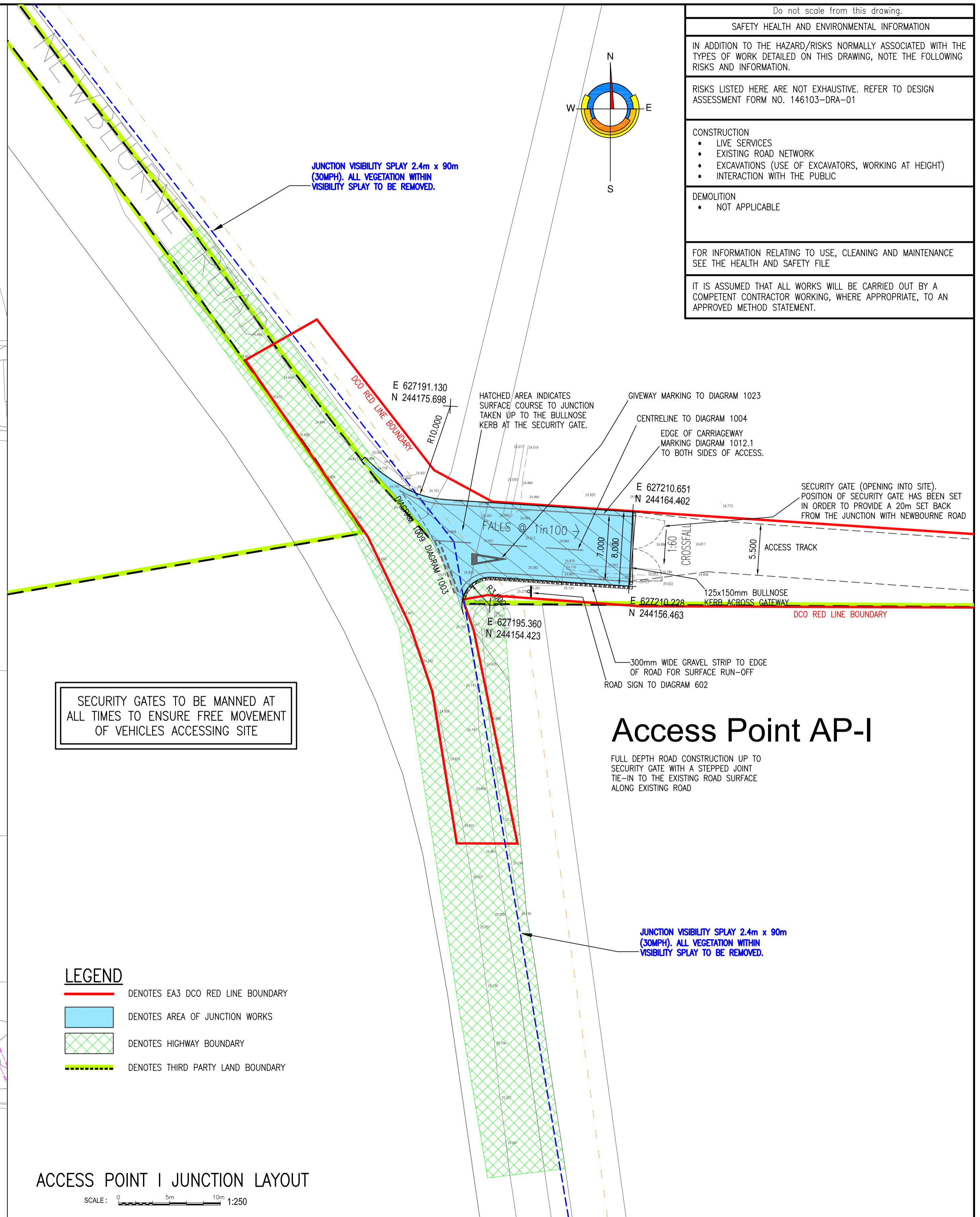

SECURITY GATES TO BE MANNED AT ALL TIMES TO ENSURE FREE MOVEMENT OF VEHICLES ACCESSING SITE

LEGEND	
[Red dashed line]	DENOTES EA3 DCO RED LINE BOUNDARY
[Blue hatched area]	DENOTES AREA OF JUNCTION WORKS
[Green hatched area]	DENOTES HIGHWAY BOUNDARY
[Yellow dashed line]	DENOTES THIRD PARTY LAND BOUNDARY

ACCESS POINT I JUNCTION LAYOUT
SCALE: 0 5m 10m 1:250

Do not scale from this drawing.	
SAFETY HEALTH AND ENVIRONMENTAL INFORMATION	
IN ADDITION TO THE HAZARD/RISKS NORMALLY ASSOCIATED WITH THE TYPES OF WORK DETAILED ON THIS DRAWING, NOTE THE FOLLOWING RISKS AND INFORMATION:	
RISKS LISTED HERE ARE NOT EXHAUSTIVE. REFER TO DESIGN ASSESSMENT FORM NO. 146103-DRA-01	
CONSTRUCTION	
<ul style="list-style-type: none"> LIVE SERVICES EXISTING ROAD NETWORK EXCAVATIONS (USE OF EXCAVATORS, WORKING AT HEIGHT) INTERACTION WITH THE PUBLIC 	
DEMOLITION	
<ul style="list-style-type: none"> NOT APPLICABLE 	
FOR INFORMATION RELATING TO USE, CLEANING AND MAINTENANCE SEE THE HEALTH AND SAFETY FILE	
IT IS ASSUMED THAT ALL WORKS WILL BE CARRIED OUT BY A COMPETENT CONTRACTOR WORKING, WHERE APPROPRIATE, TO AN APPROVED METHOD STATEMENT.	

Rev.	Date	Description	Drawn	Checked	Approved
C	18.03.22	UPDATED TO SHKW NKT ACCESS TRACK ALIGNMENT SWEEP PATHS REMOVED, REFER TO DRG 146103/1015 FOR DETAILS	ACM	GAV	GAV
B	11.03.22	JUNCTION VISIBILITY SPLAYS ADDED (2.4m x 90m) HIGHWAY BOUNDARY INFORMATION ADDED	ACM	GAV	GAV
A	20.12.21	DCO RED BOUNDARY LINE ADDED TO JUNCTION LAYOUT DETAIL. JUNCTION LAYOUT AMENDED TO REMAIN WITHIN RED LINE BOUNDARY.	ACM	GAV	GAV

Notes:	
1.	THIS DRAWING IS TO BE READ IN CONJUNCTION WITH ALL RELEVANT DRAWINGS AND SPECIFICATIONS.
2.	ALL WORKS ARE TO BE CARRIED OUT IN ACCORDANCE WITH 'THE SPECIFICATION FOR HIGHWAY WORKS'.
3.	FOR ROAD CONSTRUCTION DETAILS AND NOTES, REFER TO DRAWING No. 146103/1007.
4.	FOR ROAD SIGNAGE DETAILS AND NOTES REFER TO DRAWING No. 146103/1008.
5.	PROPOSED SIGN LOCATIONS SHOWN ARE INDICATIVE ONLY. FINAL POSITIONS TO BE ESTABLISHED ON SITE IN CONJUNCTION WITH SUFFOLK COUNTY COUNCIL.
6.	REGULAR SIGNAGE INSPECTIONS AND MAINTENANCE TO BE CARRIED OUT, FOR THE DURATION OF THE WORKS, TO AVOID POSSIBLE OBSTRUCTION BY SEASONAL VEGETATION GROWTH.

	Client: EA3 HVDC ROUTE PRE-COMMENCEMENT WORKS TRANSPORT ASSESSMENT		
		Westerton of Craigie, Southampton Road, DUNDEE, DD4 7PN Tel: 01382 453300 Fax: 0844 381 4412	
	Project Title: ACCESS POINT AP-I JUNCTION LAYOUT AND LOCATION PLAN	Scale at A1: AS SHOWN	Status: FOR APPROVAL
		Drawing No.: 146103/1004	Revision: C

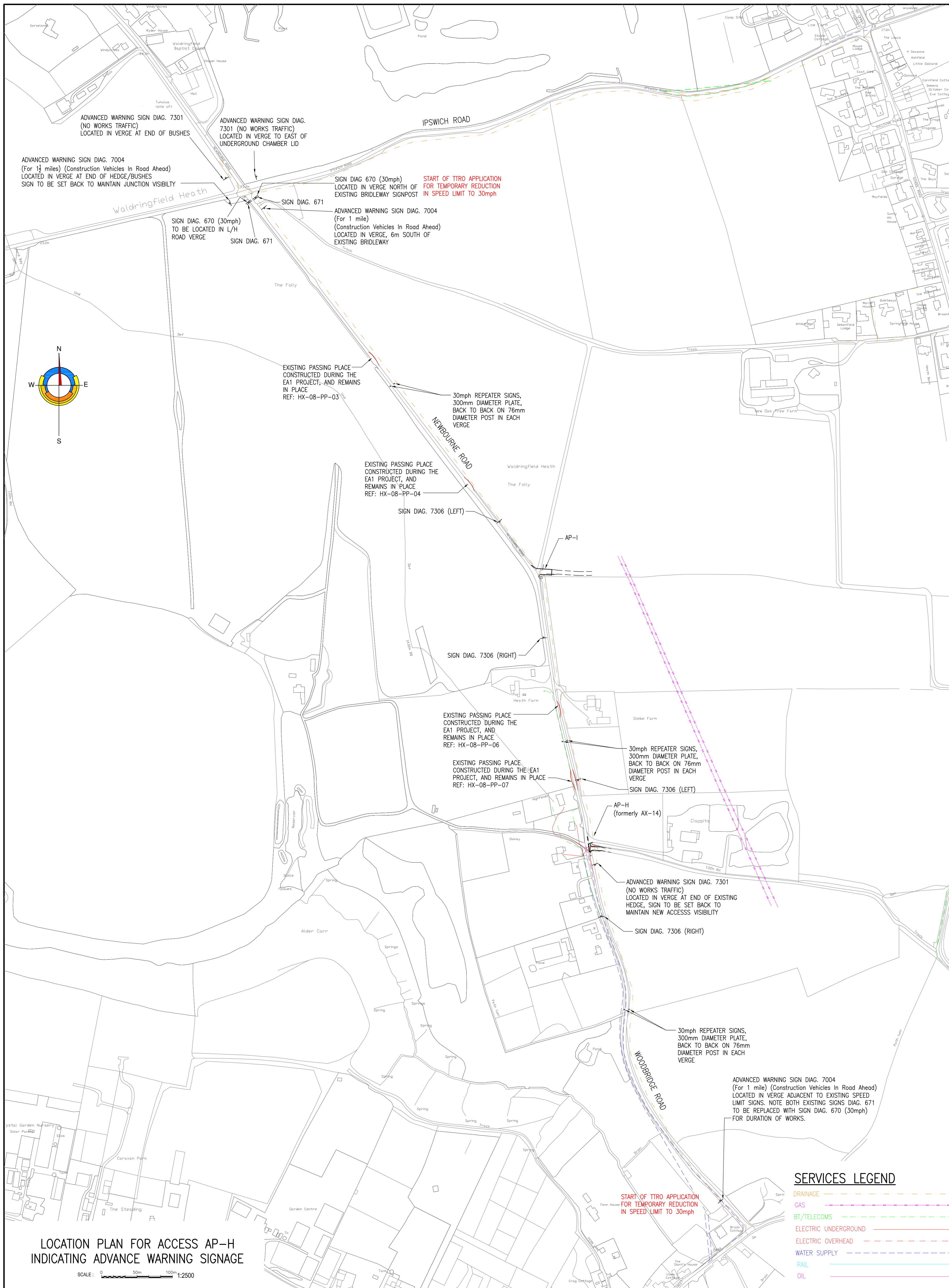

Rev	Date	Description	Drawn	Checked	Approved
G	21.04.22	EDGE OF CARRIAGEWAY FOR NORTH VISIBILITY SPLAY CLARIFIED.	ACM	MW	MW
F	15.04.22	EXTENTS OF VISIBILITY SPLAYS NOW SHOWN.	ACM	GAV	GAV
E	06.04.22	EXISTING PARISH SIGN RELOCATED. 30mph REPEATER SIGNS ADDED.	SC	GAV	GAV
D	24.03.22	GENERAL UPDATE FOLLOWING COMMENTS FROM CLIENT AND SCC.	ACM	GAV	GAV
C	18.03.22	UPDATED TO SHOW NKT ACCESS TRACK ALIGNMENT SWEEP PATHS REMOVED. REFER TO DRG 146103/1016 FOR DETAILS.	ACM	GAV	GAV
B	11.03.22	JUNCTION VISIBILITY SPLAYS UPDATED TO BE 2.4m x 90m. HIGHWAY AND THIRD PARTY LAND BOUNDARY PLAN ADDED.	ACM	GAV	GAV
A	20.12.21	DCO RED BOUNDARY LINE ADDED TO JUNCTION LAYOUT DETAIL. JUNCTION LAYOUT AMENDED TO REMAIN WITH RED LINE BOUNDARY.	ACM	GAV	GAV

Notes

- THIS DRAWING IS TO BE READ IN CONJUNCTION WITH ALL RELEVANT DRAWINGS AND SPECIFICATIONS.
- ALL WORKS ARE TO BE CARRIED OUT IN ACCORDANCE WITH 'THE SPECIFICATION FOR HIGHWAY WORKS'.
- FOR ROAD CONSTRUCTION DETAILS AND NOTES, REFER TO DRAWING NO. 146103/1007.
- FOR ROAD SIGNAGE DETAILS AND NOTES REFER TO DRAWING NO. 146103/1008.
- PROPOSED SIGN LOCATIONS SHOWN ARE INDICATIVE ONLY. FINAL POSITIONS TO BE ESTABLISHED ON SITE IN CONJUNCTION WITH SUFFOLK COUNTY COUNCIL.
- REGULAR SIGNAGE INSPECTIONS AND MAINTENANCE TO BE CARRIED OUT, FOR THE DURATION OF THE WORKS, TO AVOID POSSIBLE OBSTRUCTION BY SEASONAL VEGETATION GROWTH.
- FOR SWEEP PATH ANALYSIS PLEASE REFER TO DRAWING 146103/1016

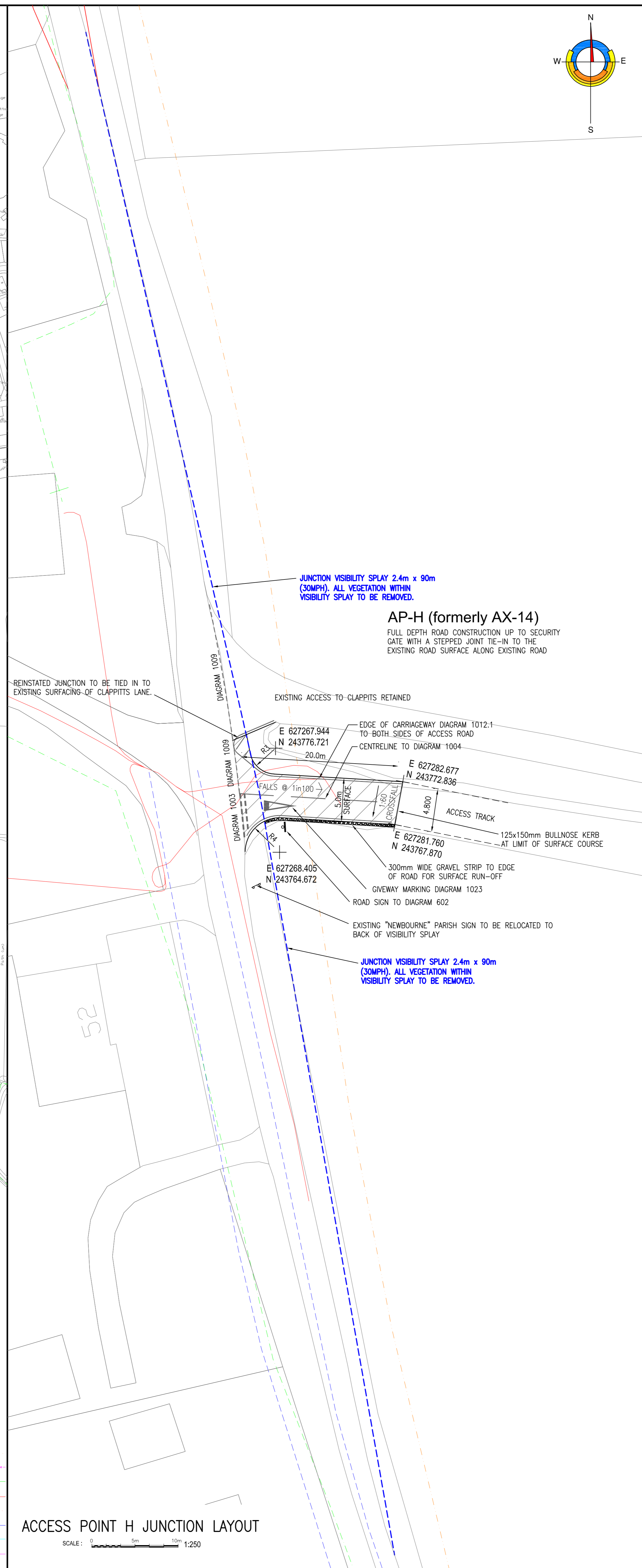
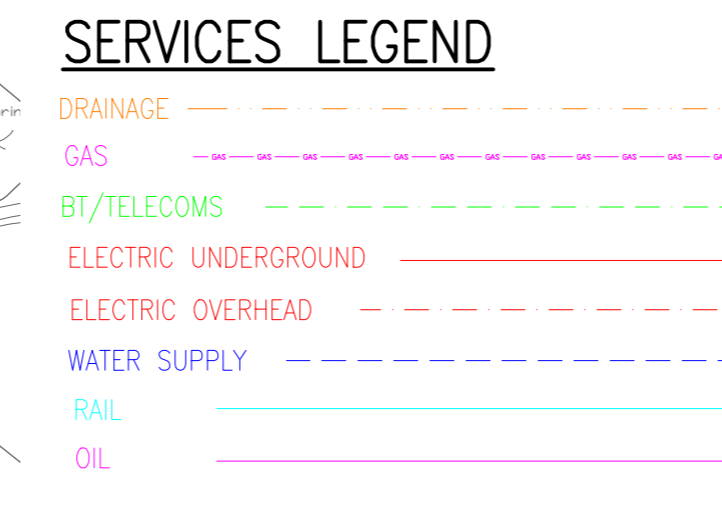

Notes

- THIS DRAWING IS TO BE READ IN CONJUNCTION WITH ALL RELEVANT DRAWINGS AND SPECIFICATIONS.
- ALL WORKS ARE TO BE CARRIED OUT IN ACCORDANCE WITH 'THE SPECIFICATION FOR HIGHWAY WORKS'.
- FOR ROAD CONSTRUCTION DETAILS AND NOTES, REFER TO DRAWING NO. 146103/1007.
- FOR ROAD SIGNAGE DETAILS AND NOTES REFER TO DRAWING NO. 146103/1008.
- PROPOSED SIGN LOCATIONS SHOWN ARE INDICATIVE ONLY. FINAL POSITIONS TO BE ESTABLISHED ON SITE IN CONJUNCTION WITH SUFFOLK COUNTY COUNCIL.
- REGULAR SIGNAGE INSPECTIONS AND MAINTENANCE TO BE CARRIED OUT, FOR THE DURATION OF THE WORKS, TO AVOID POSSIBLE OBSTRUCTION BY SEASONAL VEGETATION GROWTH.
- FOR SWEEP PATH ANALYSIS PLEASE REFER TO DRAWING 146103/1016

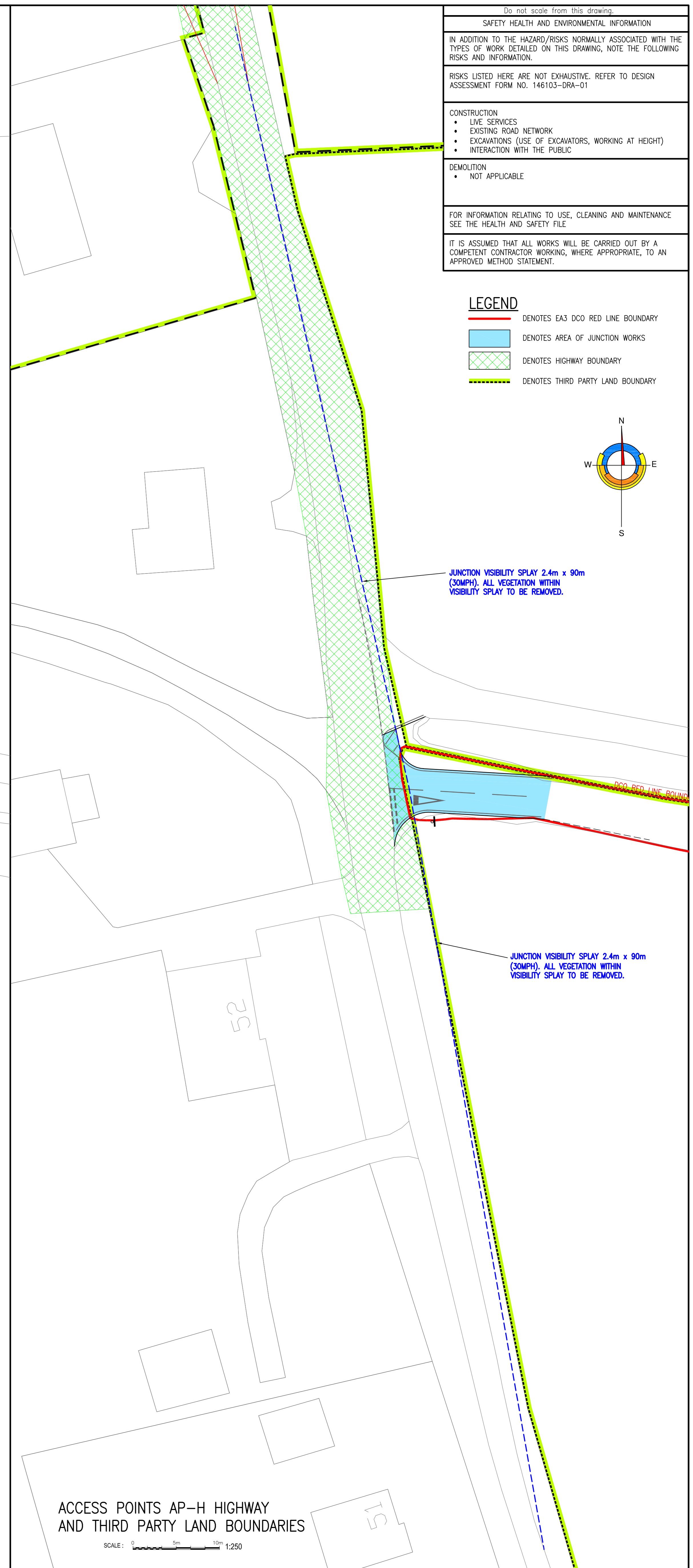

	Client:	EA3 HVDC ROUTE PRE-COMMENCEMENT WORKS TRANSPORT ASSESSMENT
	Project Title:	ACCESS POINT AP-H JUNCTION LAYOUT AND LOCATION PLAN
	Drawn:	ACM
	Checked:	GAV
	Date:	12/11/21
	Issue:	11/11/21
Drawing No.: 146103/1005		Project: FOR APPROVAL Date: 11/11/21 Issue: 11/11/21

Do not scale from this drawing.

SAFETY HEALTH AND ENVIRONMENTAL INFORMATION

IN ADDITION TO THE HAZARD/RISKS NORMALLY ASSOCIATED WITH THE TYPES OF WORK DETAILED ON THIS DRAWING, NOTE THE FOLLOWING RISKS AND INFORMATION:

RISKS LISTED HERE ARE NOT EXHAUSTIVE. REFER TO DESIGN ASSESSMENT FORM NO. 146103-00A-01

CONSTRUCTION

- LIVE SERVICES
- EXISTING ROAD NETWORK
- EXCAVATIONS (USE OF EXCAVATORS, WORKING AT HEIGHT)
- INTERACTION WITH THE PUBLIC

DEMOLITION

- NOT APPLICABLE

FOR INFORMATION RELATING TO USE, CLEANING AND MAINTENANCE SEE THE HEALTH AND SAFETY FILE

IT IS ASSUMED THAT ALL WORKS WILL BE CARRIED OUT BY AN COMPETENT CONTRACTOR WORKING, WHERE APPROPRIATE, TO AN APPROVED METHOD STATEMENT.

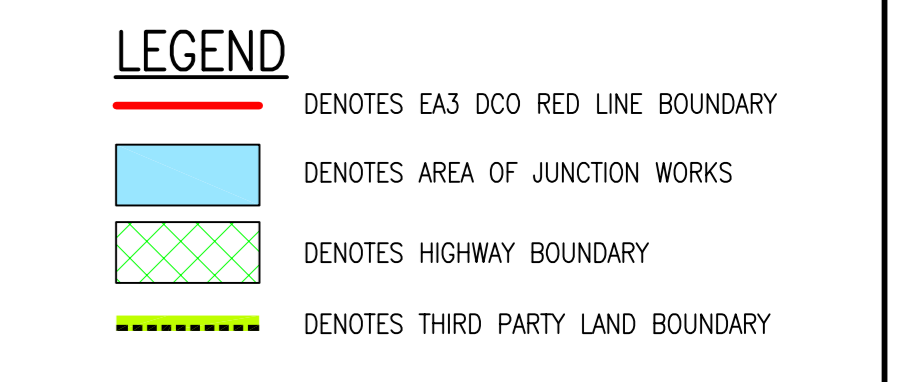

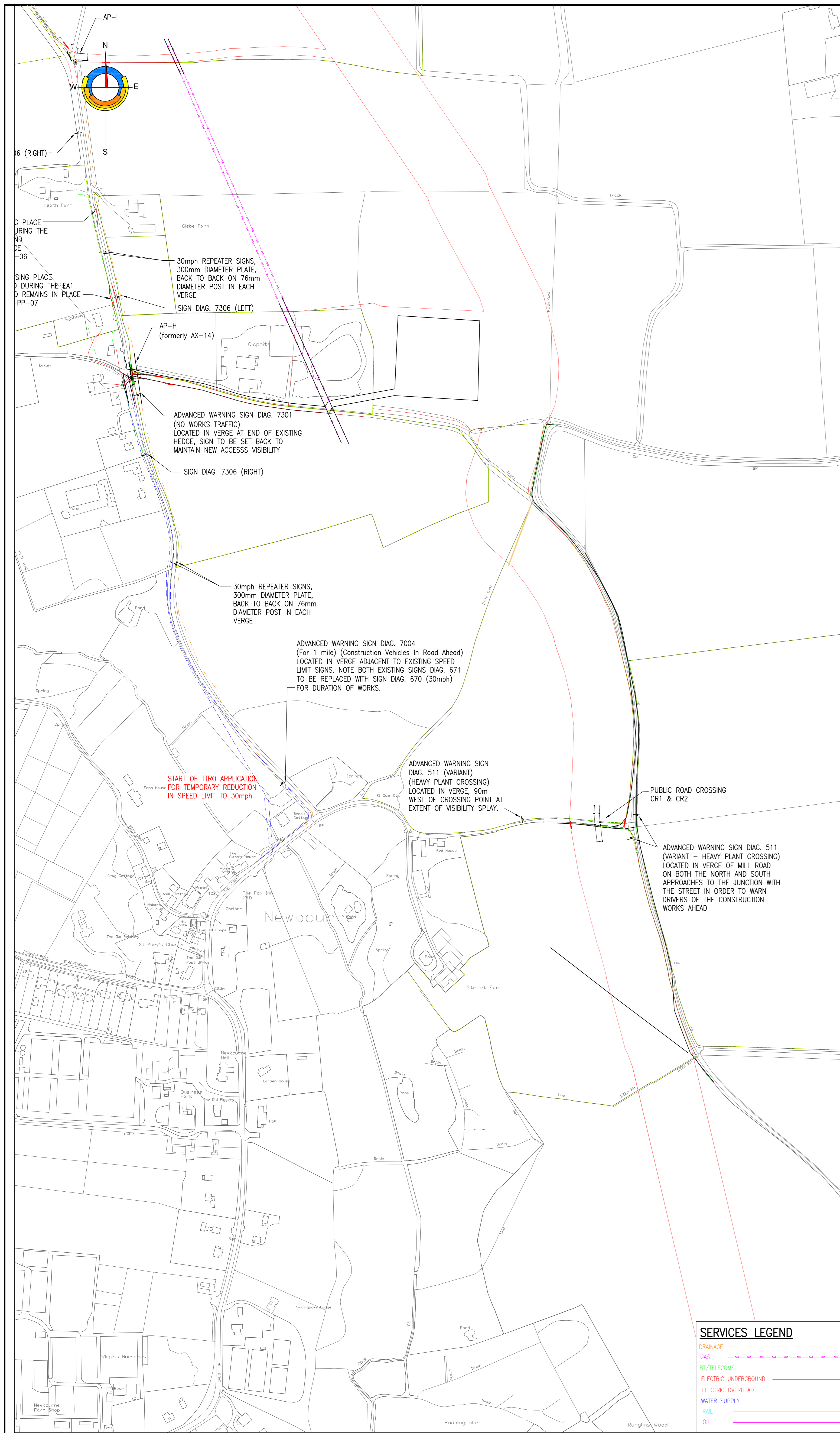

LOCATION PLAN FOR PUBLIC ROAD CROSSING, THE STREET, INDICATING ADVANCE WARNING SIGNAGE

SCALE: 1:2500

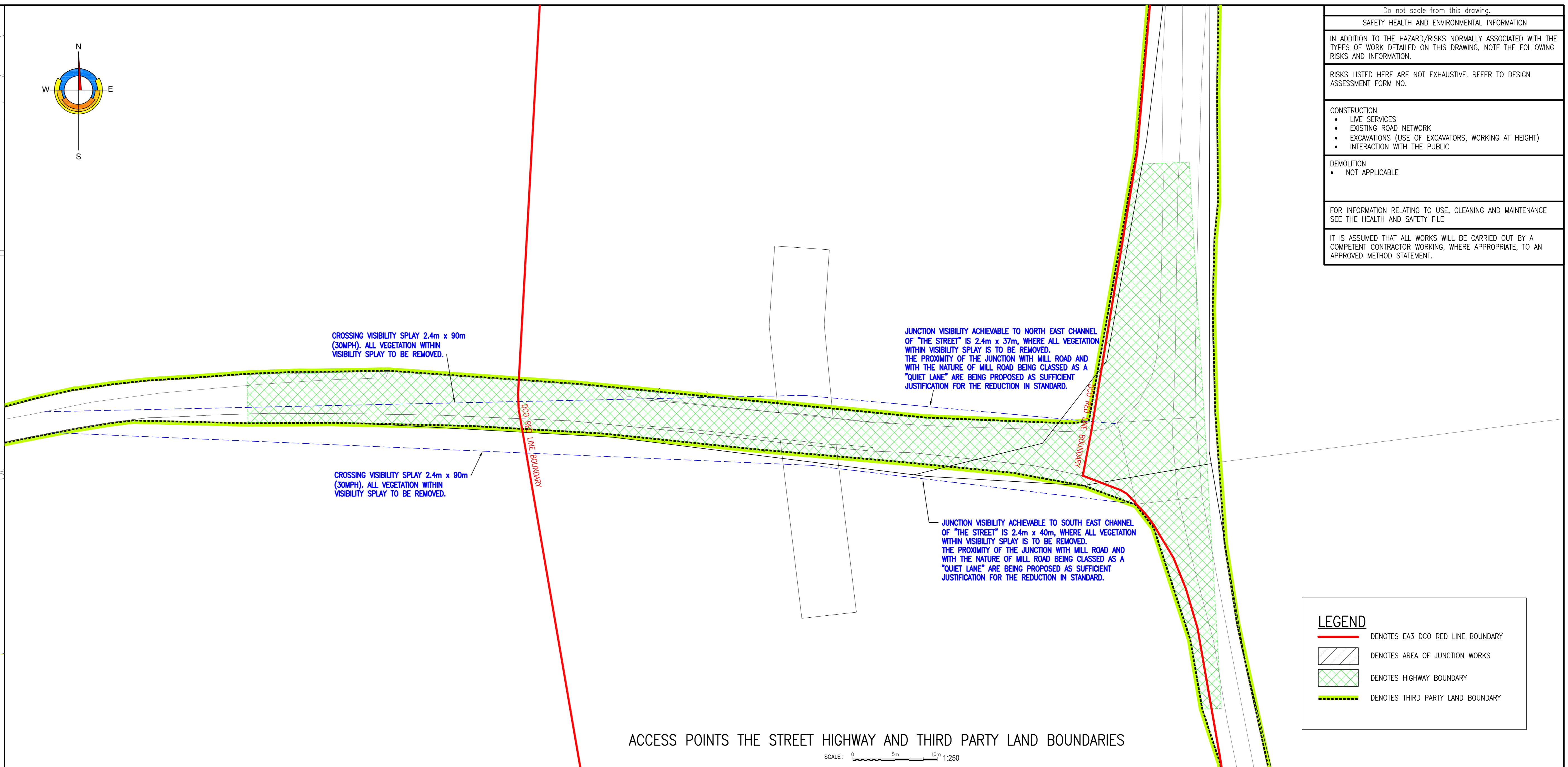

ACCESS POINTS THE STREET HIGHWAY AND THIRD PARTY LAND BOUNDARIES

SCALE: 1:250

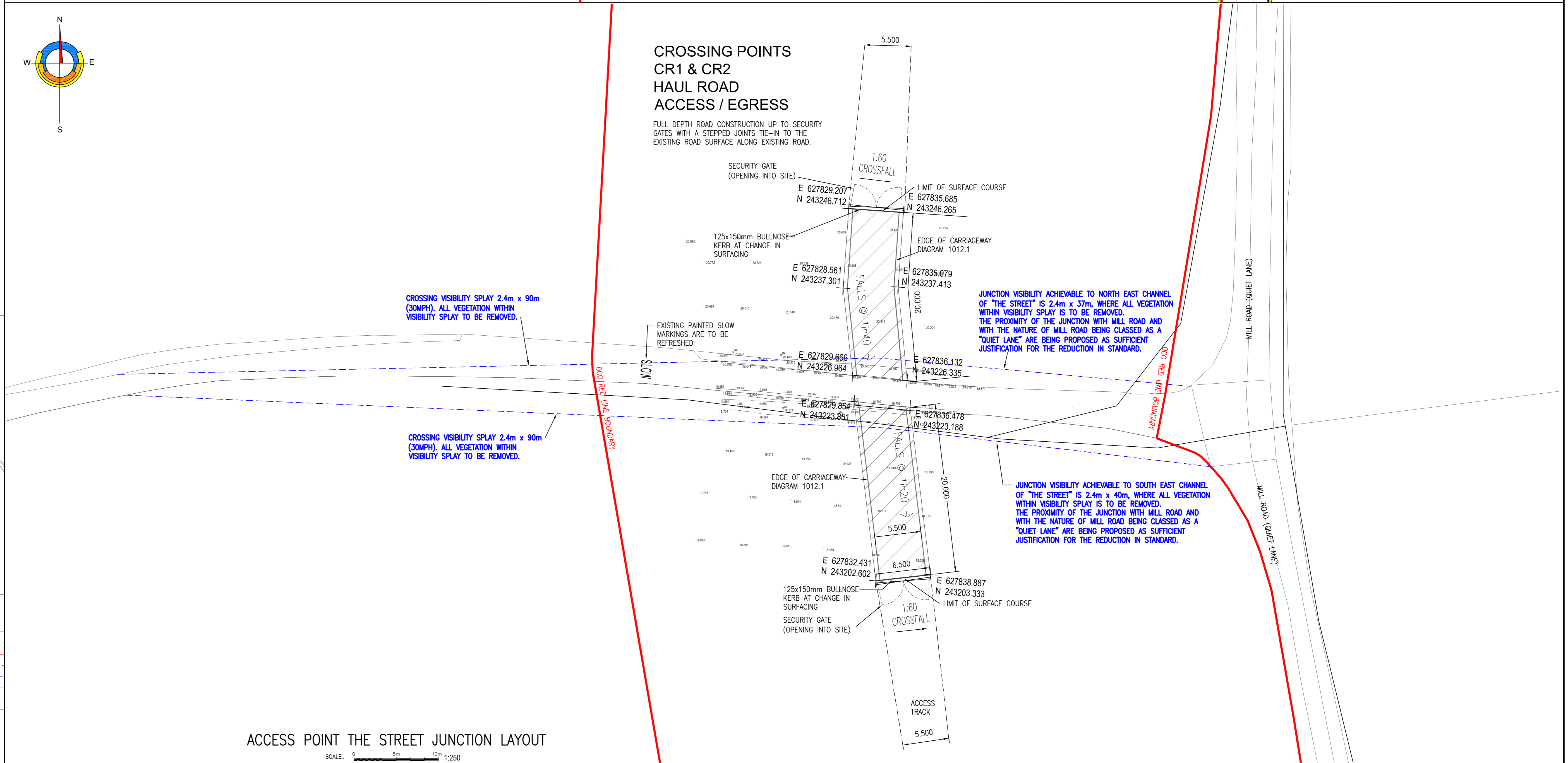

ACCESS POINT THE STREET JUNCTION LAYOUT

SCALE: 1:250

Do not scale from this drawing.

SAFETY HEALTH AND ENVIRONMENTAL INFORMATION

IN ADDITION TO THE HAZARD/RISKS NORMALLY ASSOCIATED WITH THE TYPES OF WORK DETAILED ON THIS DRAWING, NOTE THE FOLLOWING RISKS AND INFORMATION:

RISKS LISTED HERE ARE NOT EXHAUSTIVE. REFER TO DESIGN ASSESSMENT FORM NO.

CONSTRUCTION

- LIVE SERVICES
- EXISTING ROAD NETWORK
- EXCAVATIONS (USE OF EXCAVATORS, WORKING AT HEIGHT)
- INTERACTION WITH THE PUBLIC

DEMOLITION

- NOT APPLICABLE

FOR INFORMATION RELATING TO USE, CLEANING AND MAINTENANCE SEE THE HEALTH AND SAFETY FILE

IT IS ASSUMED THAT ALL WORKS WILL BE CARRIED OUT BY A COMPETENT CONTRACTOR WORKING, WHERE APPROPRIATE, TO AN APPROVED METHOD STATEMENT.

LEGEND

- DENOTES EAS DCO RED LINE BOUNDARY
- DENOTES AREA OF JUNCTION WORKS
- DENOTES HIGHWAY BOUNDARY
- DENOTES THIRD PARTY LAND BOUNDARY

Rev.	Date	Description	Drawn	Checked	Approved
D	25.04.22	UPDATED TO SHOW FULL EXTENT OF VISIBILITY SPLAYS	ACM	GAV	GAV
C	18.03.22	UPDATED TO SHOW NKT ACCESS TRACK ALIGNMENT	ACM	GAV	GAV
B	11.03.22	VISIBILITY SPLAYS ADDED TO CROSSING, ADVANCE WARNING SIGNS UPDATED	ACM	GAV	GAV
A	20.12.21	DCO RED BOUNDARY LINE ADDED TO JUNCTION LAYOUT DETAIL.	ACM	GAV	GAV

- Notes:
- THIS DRAWING IS TO BE READ IN CONJUNCTION WITH ALL RELEVANT DRAWINGS AND SPECIFICATIONS.
 - ALL WORKS ARE TO BE CARRIED OUT IN ACCORDANCE WITH 'THE SPECIFICATION FOR HIGHWAY WORKS'.
 - FOR ROAD CONSTRUCTION DETAILS AND NOTES, REFER TO DRAWING No. 146103/1007.
 - FOR ROAD SIGNAGE DETAILS AND NOTES REFER TO DRAWING No. 146103/1008.
 - PROPOSED SIGN LOCATIONS SHOWN ARE INDICATIVE ONLY. FINAL POSITIONS TO BE ESTABLISHED ON SITE IN CONJUNCTION WITH SUFFOLK COUNTY COUNCIL.
 - REGULAR SIGNAGE INSPECTIONS AND MAINTENANCE TO BE CARRIED OUT, FOR THE DURATION OF THE WORKS, TO AVOID POSSIBLE OBSTRUCTION BY SEASONAL VEGETATION GROWTH.

Project Title: **EA3 HVDC ROUTE PRE-COMMENCEMENT WORKS TRANSPORT ASSESSMENT**

Client: **NIKT**

Contractor: **SCOTTISHPOWER RENEWABLES**

Revision: 146103/1006

Date: 17/03/2022

Scale: 1:2500

Author: ACM

Checked: GAV

Approved: GAV

Project No: 146103/1006

Sheet No: D

FAIRHURST

Station of Grange, Southampton Road, BUNBLE, SO4 79U
Tel: 01382 453300 Fax: 0844 281 4412

Rev.	Date	Description	Drawn	Checked	Approved
AS SHOWN					

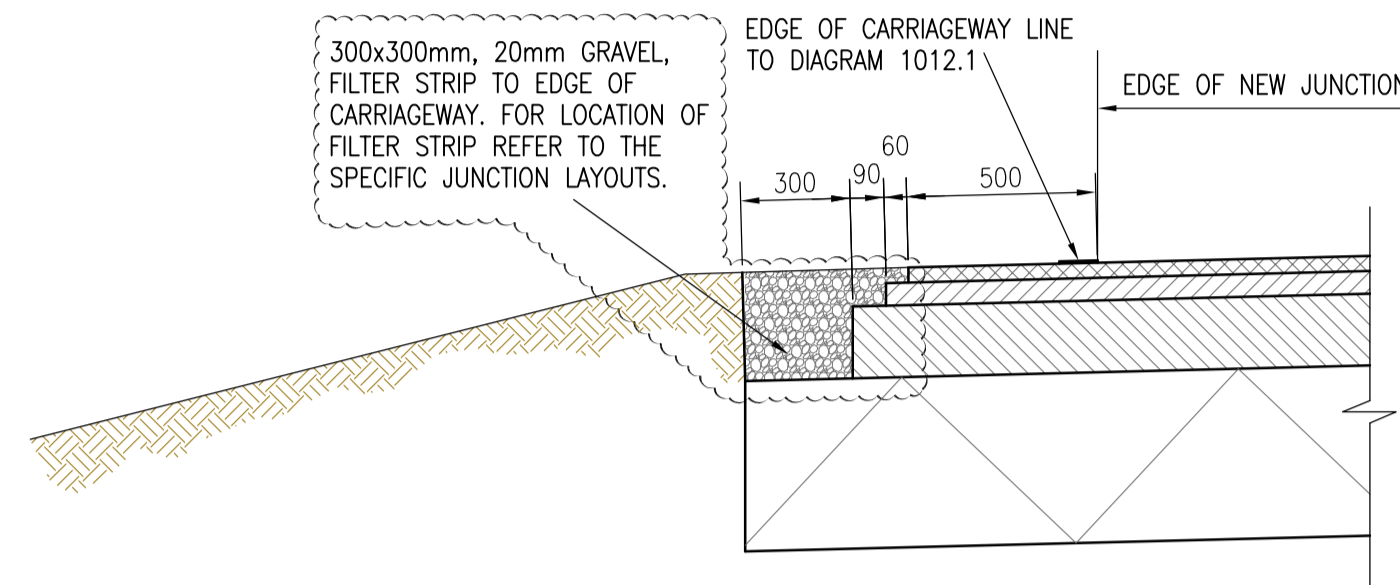

CROSS SECTION THROUGH EDGE OF NEW ACCESS CONSTRUCTION

SCALE 1:20

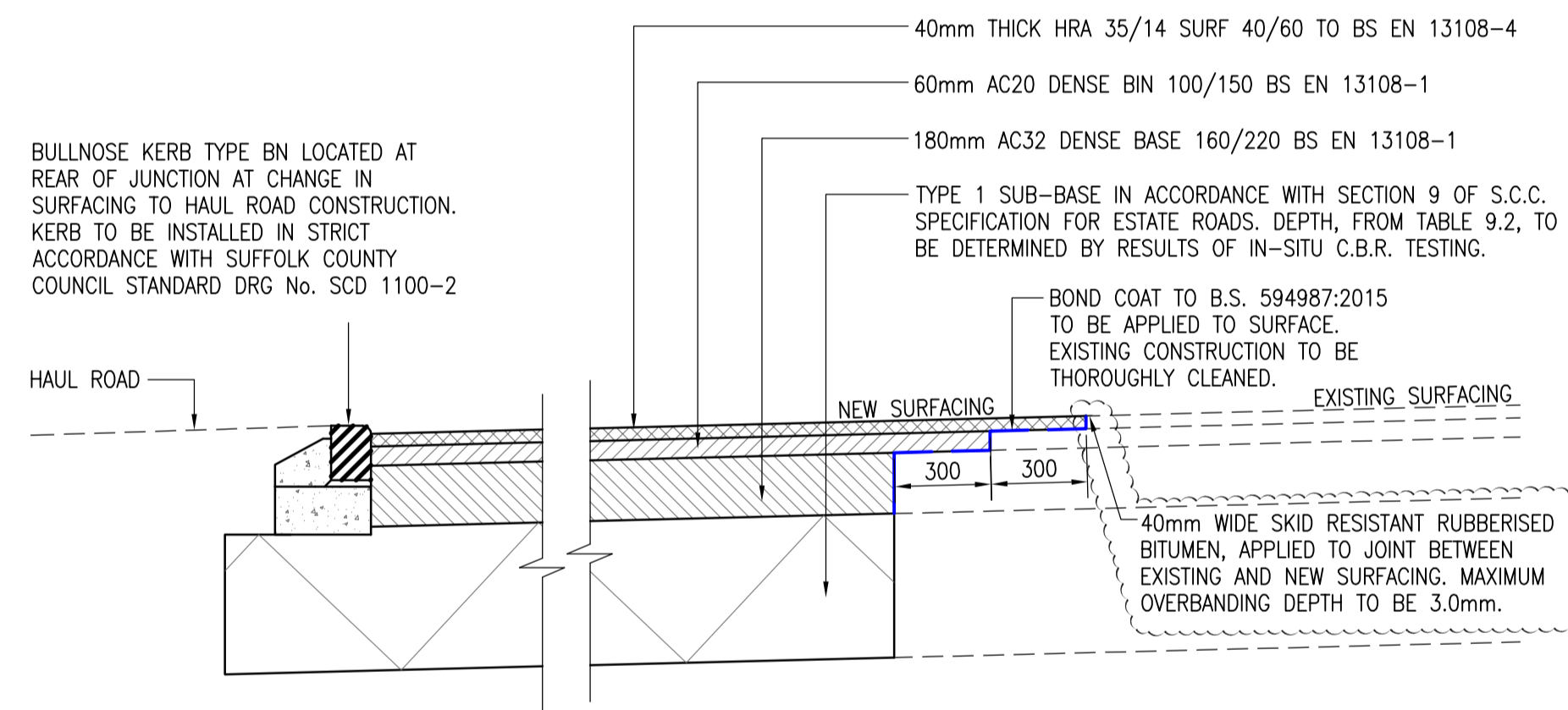

SECTION THROUGH NEW ACCESS CONSTRUCTION AT TIE-IN TO EXISTING CARRIAGEWAY

SCALE 1:20

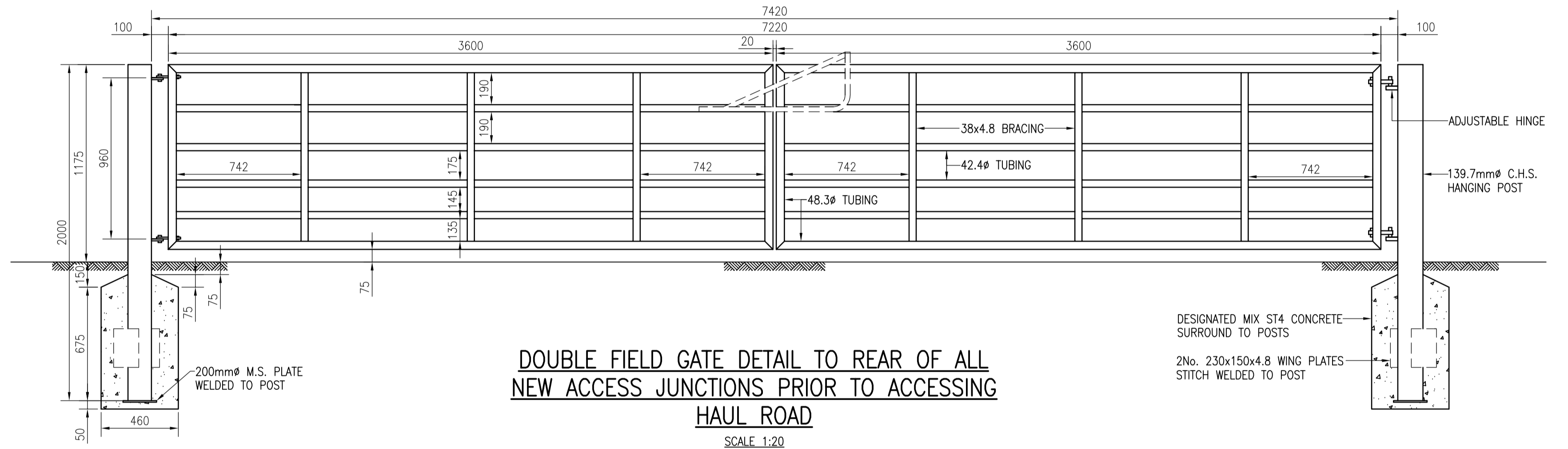

DOUBLE FIELD GATE DETAIL TO REAR OF ALL NEW ACCESS JUNCTIONS PRIOR TO ACCESSING HAUL ROAD

SCALE 1:20

- Notes:
- FOR ACCESS POINT W REFER TO DRAWING 146103/1003.
 - FOR ACCESS POINT I REFER TO DRAWING 146103/1004.

Rev.	Date	Description	Drawn	Checked	Approved
B	15.04.22	FILTER DRAIN AND JOINT SEAL DETAILS ADDED TO SECTIONS. AMENDMENTS SHOWN CLOUDED.	ACM	GAV	GLB
A	06.04.22	KERB DETAIL UPDATED.	ACM	GAV	GLB

Client:

Client:

Project Title:

**EA3 HVDC ROUTE
PRE-COMMENCEMENT WORKS
TRANSPORT ASSESSMENT**

Drawing Title:

CONSTRUCTION DETAILS

FAIRHURST

Westerton of Craigie,
Southampton Road, DUNDEE, DD4 7PN
Tel: 01382 453300 Fax: 0844 381 4412

Scale at A1:
1:20

Status:
FOR APPROVAL

Drawn: SC	Checked: GAV	Approved: GAV
Date: 10/11/21	Date: 10/11/21	Date: 10/11/21

Drawing No.: **146103/1007** Revision: **B**

Do not scale from this drawing.

SAFETY HEALTH AND ENVIRONMENTAL INFORMATION

IN ADDITION TO THE HAZARD/RISKS NORMALLY ASSOCIATED WITH THE TYPES OF WORK DETAILED ON THIS DRAWING, NOTE THE FOLLOWING RISKS AND INFORMATION:

RISKS LISTED HERE ARE NOT EXHAUSTIVE. REFER TO DESIGN ASSESSMENT FORM NO. 146103-DRA-01

- CONSTRUCTION :
- INTERFACE WITH THE PUBLIC
 - DEEP EXCAVATIONS
 - PRESENCE OF UNKNOWN LIVE SERVICES
 - OVERHEAD SERVICES
 - WORKING ON OR NEAR TO THE HIGHWAY

- DEMOLITION
- NOT APPLICABLE

FOR INFORMATION RELATING TO USE, CLEANING AND MAINTENANCE SEE THE HEALTH AND SAFETY FILE

IT IS ASSUMED THAT ALL WORKS WILL BE CARRIED OUT BY A COMPETENT CONTRACTOR WORKING, WHERE APPROPRIATE, TO AN APPROVED METHOD STATEMENT.

- NOTES:
1. THIS DRAWING IS TO BE READ IN CONJUNCTION WITH ALL RELEVANT DRAWINGS AND SPECIFICATIONS.
 2. FOR LOCATION OF SIGNS REFER TO THE DETAILED LAYOUT DRAWINGS SPECIFIC TO EACH ACCESS POINT AND/OR CROSSING POINT

NOTE:
FOR REQUIRED DISTANCE ANNOTATION, REFER TO THE DETAILED LAYOUT DRAWINGS SPECIFIC TO EACH ACCESS POINT AND/OR CROSSING POINT.

Oncoming vehicles in middle of road
DIAGRAM 575
SIZE : 600mm
X-HEIGHT : 62.5mm
BACKGROUND : WHITE
TEXT : BLACK
BORDER : BLACK
MATERIAL : CLASS RA2
POSTS : 76mmØ POST
BASES : 600x600x600mm
MOUNTING HEIGHT : 2250mm
LATERAL CLEARANCE : 500mm MIN

Cross
DIAGRAM 504.1
SIZE : 600mm
BACKGROUND : WHITE
BORDER : RED
MATERIAL : CLASS RA2
POSTS : 76mmØ POST
BASES : 600x600x600mm
MOUNTING HEIGHT : 2250mm
LATERAL CLEARANCE : 500mm MIN

GIVE WAY
DIAGRAM 602
SIZE : 600mm
TEXT COLOUR : BLACK
BACKGROUND : WHITE
BORDER : RED
MATERIAL : CLASS RA2
POSTS : 76mmØ POST
BASES : 600x600x600mm
MOUNTING HEIGHT : 2250mm
LATERAL CLEARANCE : 500mm MIN

STOP
DIAGRAM 601.1
SIZE : 600mm
TEXT COLOUR : WHITE
BACKGROUND : RED
BORDER : WHITE
MATERIAL : CLASS RA2
POSTS : 76mmØ POST
BASES : 600x600x600mm
MOUNTING HEIGHT : 2250mm
LATERAL CLEARANCE : 500mm MIN

No entry
DIAGRAM 671
SIZE : 600mmØ
LINE COLOUR : BLACK
BACKGROUND : WHITE
MATERIAL : CLASS RA2
POSTS : 76mmØ POST
BASES : 600x600x600mm
MOUNTING HEIGHT : 2250mm
LATERAL CLEARANCE : 500mm MIN

30
DIAGRAM 670 (30mph)
SIZE : 600mmØ
TEXT COLOUR : BLACK
BACKGROUND : WHITE
BORDER : RED
MATERIAL : CLASS RA2
POSTS : 76mmØ POST
BASES : 600x600x600mm
MOUNTING HEIGHT : 2250mm
LATERAL CLEARANCE : 500mm MIN
BACKING BOARD : YELLOW

30
DIAGRAM 670 (30mph)
(REPEATER SIGNS)
SIZE : 300mmØ
TEXT COLOUR : BLACK
BACKGROUND : WHITE
BORDER : RED
MATERIAL : CLASS RA2
POSTS : 76mmØ POST
BASES : 600x600x600mm
MOUNTING HEIGHT : 2250mm
LATERAL CLEARANCE : 500mm MIN

Construction traffic in road ahead

Signing Project	EA3	Width (mm)	1665	Background Border Legend	Yellow Black Black
Sign Reference x Height	7004 75.0	Height (mm)	600		
Material	Class RA2	Area (m²)	1.00		

Construction traffic in road ahead
For XX miles

Signing Project	EA3	Width (mm)	1925	Background Border Legend	Yellow Black Black
Sign Reference x Height	7004 75.0	Height (mm)	1065		
Material	Class RA2	Area (m²)	2.05		

Structural Calculation Details SIGN 7004

Signs:
Reference: 7004
Width: 1925mm, Height: 1065mm
Shape: Rectangle
Orientation: Facing front
Mounted on posts: 1, 2
Mounting height: 2100mm

Posts:
Quantity: 2
Type: 88.9 x 3.2 CHS
Spacing: 1425mm
Post 1 Length: 3865mm
Post 2 Length: 3865mm

Base:
Type: Combined
Width: 1900mm
Length: 1900mm
Depth: 600mm
Volume: 2.17cu.m
Earth cover: 100mm
Blinding layer: 0mm

WORKS ACCESS ONLY 100 yds
7306 (LEFT)

WORKS ACCESS ONLY 100 yds
7306 (RIGHT)

HEAVY PLANT CROSSING
SIGN REFERENCE : DIAGRAM 511 (VARIANT)

NO WORKS TRAFFIC
SIGN REFERENCE : DIAGRAM 7301 (VARIANT)

WORKS TRAFFIC
7304 (LEFT)

WORKS TRAFFIC
7304 (RIGHT)

X-HEIGHT : 62.5mm
MATERIAL : CLASS RA2
POSTS : 2x76mmØ POST
BASE : 1300x650x650mm
MOUNTING HEIGHT : 2250mm
LATERAL CLEARANCE : 500mm MIN

X-HEIGHT : 62.5mm
MATERIAL : CLASS RA2
POSTS : 1x76mmØ POST
BASE : 650x650x650mm
MOUNTING HEIGHT : 2250mm
LATERAL CLEARANCE : 500mm MIN

X-HEIGHT : 62.5mm
MATERIAL : CLASS RA2
POSTS : 1x76mmØ POST
BASE : 650x650x650mm
MOUNTING HEIGHT : 2250mm
LATERAL CLEARANCE : 500mm MIN

X-HEIGHT : 62.5mm
MATERIAL : CLASS RA2
POSTS : 1x76mmØ POST
BASE : 650x650x650mm
MOUNTING HEIGHT : 2250mm
LATERAL CLEARANCE : 500mm MIN

ALTERNATIVE FOUNDATION DETAIL FOR SIGN POST IS TO USE A LENGTH OF DRAINAGE PIPE WITH THE INTERNAL DIAMETER SUITABLE FOR THE SIGN POST DIAMETER.

1. ONCE THE VERGE HAS BEEN CLEARED FOR SERVICES USING A "CAT-SCAN", HOLE TO BE EXCAVATED TO A DEPTH OF 750mm BELOW EXISTING GROUND LEVEL. DRAINAGE PIPE TO BE INSERTED, WITH THE EXCAVATED HOLE, EXTERNAL TO THE PIPE, BACKFILLED USING RAMMED EARTH.
2. SIGNPOST TO BE INSERTED TO DRAINAGE PIPE, THEN BACKFILLED WITH GRAVEL. TIMBER WEDGES TO BE DRIVEN BETWEEN THE SIGN POST AND INSIDE OF DRAINAGE PIPE TO STABILIZE SIGN.
3. SIGN POST TO BE CHECKED AT REGULAR INTERVALS FOR THE DURATION OF THE CONTRACT.

Rev.	Date	Description	Drawn	Checked	Approved
C	13.04.22	STOP SIGN TO DIAGRAM 601.1 ADDED	ACM	GAV	GAV
B	05.04.22	30mph REPEATER SIGN DETAIL ADDED. NOTE REGARDING ALTERNATIVE FOUNDATION DETAIL ADDED.	ACM	GAV	GAV
A	12.11.21	ADDITIONAL SIGNS ADDED	ACM	GAV	GAV

	Client:		Project Title:	EA3 HVDC ROUTE PRE-COMMENCEMENT WORKS TRANSPORT ASSESSMENT	
			Project Title:		
Scale at A1: AS SHOWN			Status: FOR APPROVAL		
Drawn: SC		Checked: ACM		Approved: GAV	
Date: 10/11/21		Date: 10/11/21		Date: 10/11/21	
Drawing No.: 146103/1008				Revision: C	

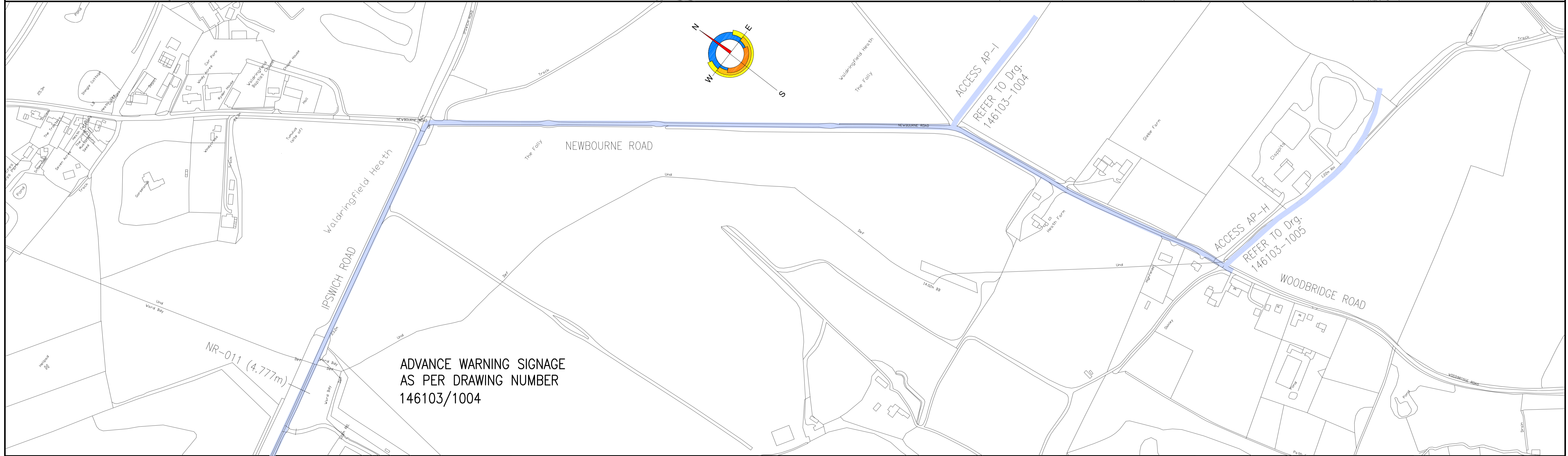
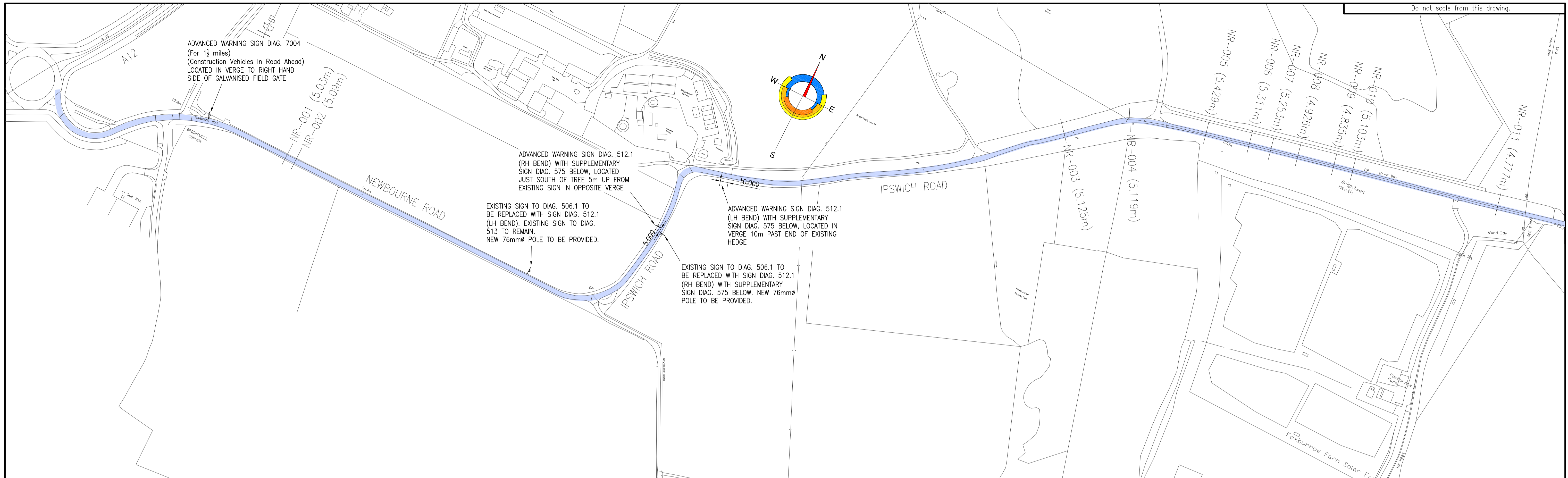

Rev.	Date	Description	Drawn	Checked	Approved
A	11.03.22	ADVANCE WARNING SIGNS ADDED TO ROUTE WHEN LEAVING THE A12	ACM	GAV	GAV

- Notes:
1. DENOTES ACCESS ROUTE FROM A12.
 2. FOR DETAILED JUNCTION ARRANGEMENTS AT AP-H AND AP-I REFER TO DRAWING 146103/1004.
 3. NR..... DENOTES TREE SURVEY LOCATION WITH SURVEYED HEIGHTS IN BRACKETS.
 4. BASED ON AN ALLOWANCE OF 5.4m HEIGHT (CABLE DRUM ON LOW-LOADER) ANY TREE BRANCHES BELOW THIS HEIGHT SHOULD BE REMOVED.
 5. REFER TO DRAWING NUMBER 146103/1008 FOR SIGN DETAILS

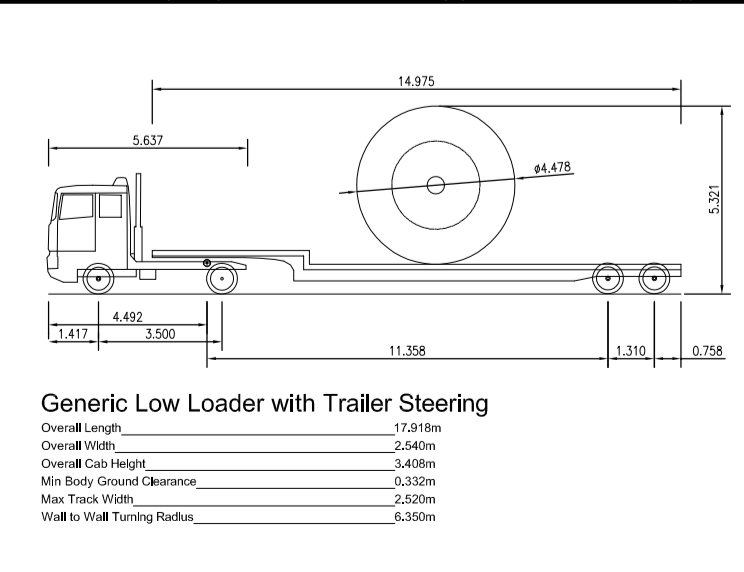

Client:

Project Title:
**EA3 HVDC ROUTE
PRE-COMMENCEMENT WORKS
TRANSPORT ASSESSMENT**

Drawing Title:
**NEWBOURNE ROAD ACCESS ROUTE
TO AP-H AND AP-I**

FAIRHURST

Westerton of Craigie,
Southampton Road, DUNDEE, DD4 7PN
Tel: 01382 453300 Fax: 0844 381 4412

Scale at A1: 1:2500	Status: FOR APPROVAL	
Drawn: SC	Checked: GAV	Approved: GAV
Date: 10/11/21	Date: 11/03/22	Date: 11/03/22
Drawing No.:	Revision:	
146103/1009	A	

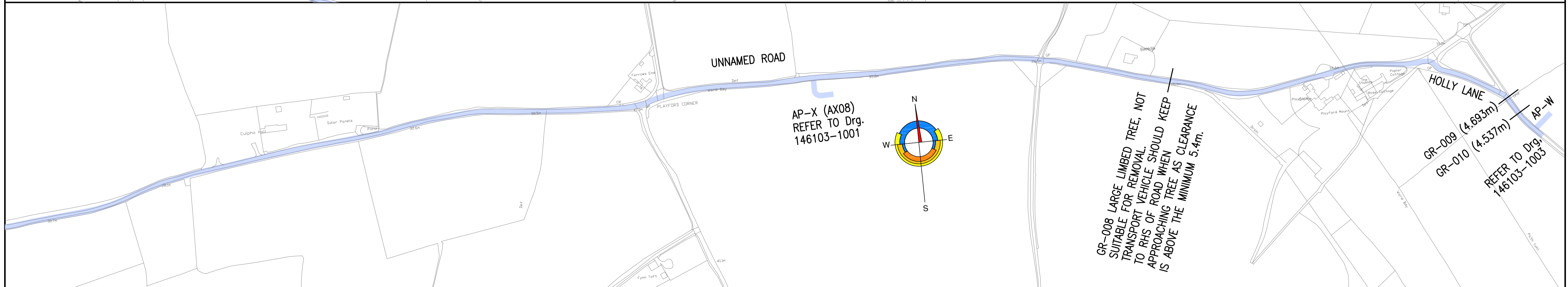
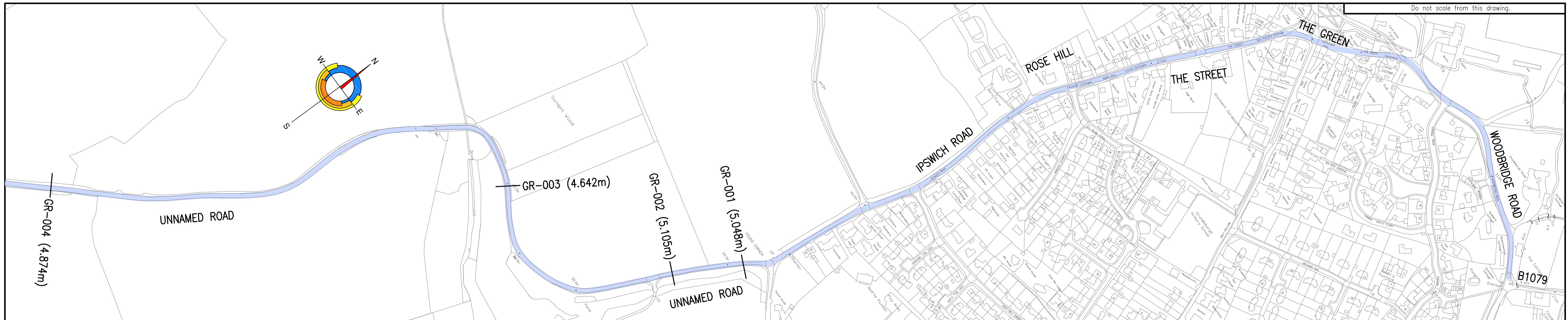

Rev.	Date	Description	Drawn	Checked	Approved

- Notes:
1. DENOTES ACCESS ROUTE FROM B1079.
 2. FOR DETAILED JUNCTION ARRANGEMENT AT AP-X, REFER TO DRAWING NUMBER 146103/1001
 3. FOR DETAILED JUNCTION ARRANGEMENT AT AP-W, REFER TO DRAWING NUMBER 146103/1003.
 4. GR..... DENOTES TREE SURVEY LOCATION WITH SURVEYED HEIGHTS TO BRANCHES IN BRACKETS.
 5. BASED ON AN ALLOWANCE OF 5.4m HEIGHT (CABLE DRUM ON LOW-LOADER) ANY TREE BRANCHES BELOW THIS HEIGHT SHOULD BE REMOVED.
 6. FOR ADVANCE WARNING SIGNS, REFER TO DRAWINGS NUMBER 146103/1001 AND 146103/1003

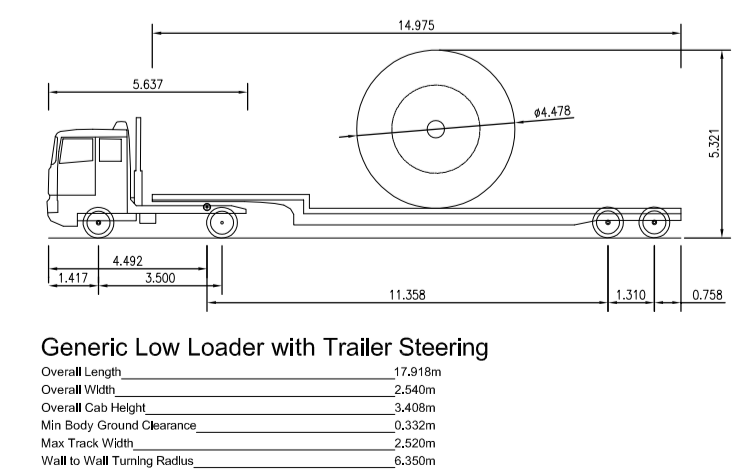

Client:

Project Title:
EA3 HVDC ROUTE
PRE-COMMENCEMENT WORKS
TRANSPORT ASSESSMENT

Drawing Title:
GRUNDISBURGH ROAD ACCESS
ROUTE TO AP-X AND AP-W

Westerton of Craigie,
Southampton Road, DUNDEE, DD4 7PN
Tel: 01382 453300 Fax: 0844 381 4412

Scale at A1: 1:2500	Status: FOR APPROVAL	
Drawn: SC	Checked: GAV	Approved: GAV
Date: 10/11/21	Date: 10/11/21	Date: 10/11/21
Drawing No.: 146103/1010	Revision: -	

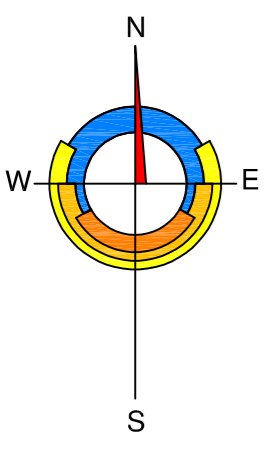



AP-G
 REFER TO Drg,
 146103-1000
 AP-F

SCALE: 0 25m 50m 1:1250

Rev.	Date	Description	Drawn	Checked	Approved
A	25.04.22	SCALE CHANGED AND SCALEBAR ADDED. NOTES UPDATED.	GAV	ACM	SGD

Notes:
 1. DENOTES ACCESS ROUTE FROM A14.
 2. FOR DETAILED JUNCTION ARRANGEMENTS AT AP-F AND AP-G REFER TO DRAWING 146103/1000.

Client:

Project Title:
**EA3 HVDC ROUTE
 PRE-COMMENCEMENT WORKS
 TRANSPORT ASSESSMENT**

Drawing Title:
**A14 TO PAPER MILL LANE
 ACCESS ROUTE
 TO AP-F AND AP-G**

FAIRHURST
 Westerton of Craigie,
 Southampton Road, DUNDEE, DD4 7PN
 Tel: 01382 453300 Fax: 0844 381 4412

Scale at A1: 1:1250	Status: FOR APPROVAL
Drawn: ACM	Checked: GAV
Date: 12/11/21	Date: 12/11/21
Approved: GAV	Date: 12/11/21

Drawing No.: **146103/1011** Revision: **A**

Do not scale from this drawing.

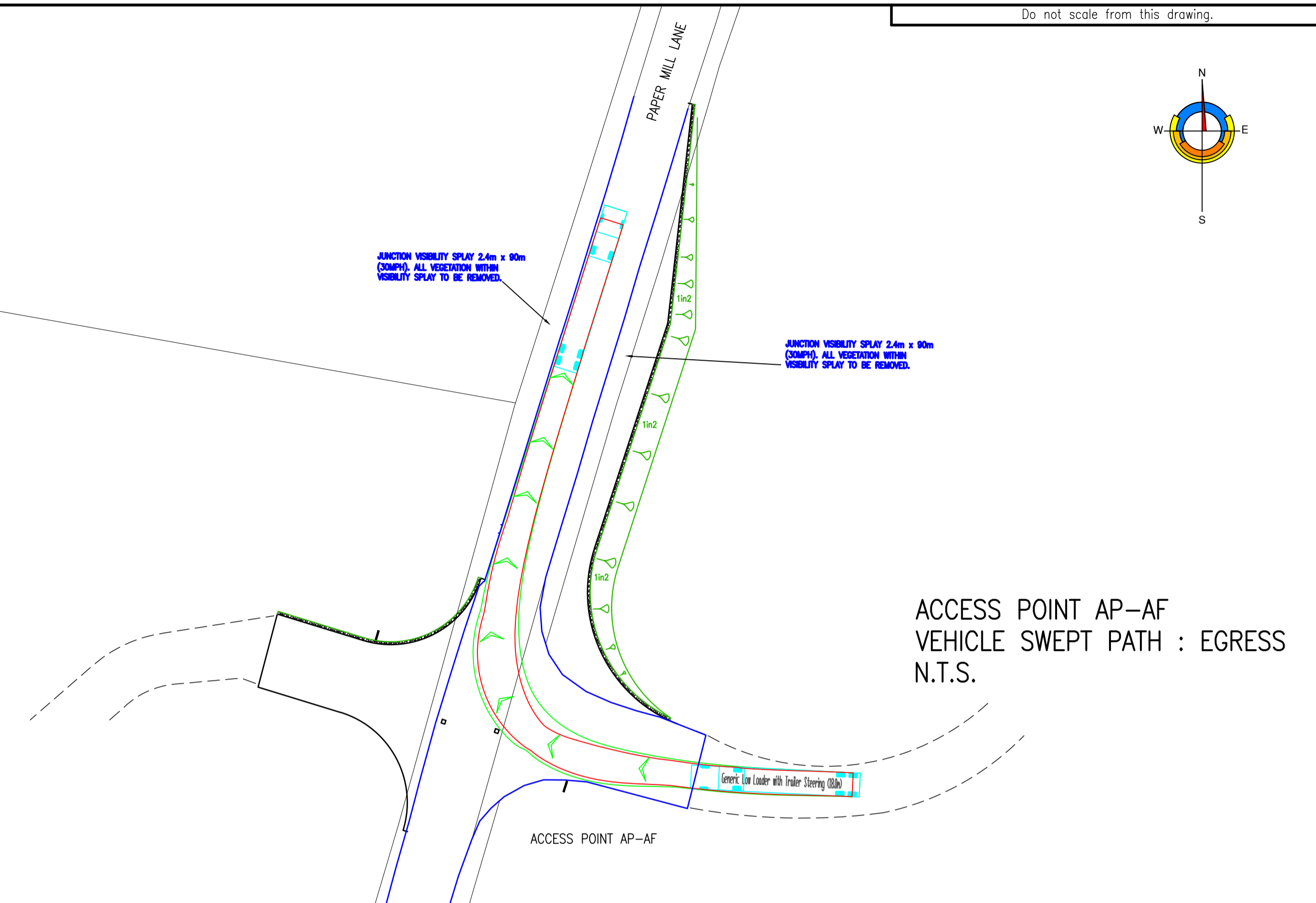
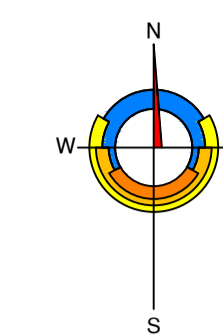

ACCESS POINT AP-AF
VEHICLE SWEEP PATH : EGRESS
N.T.S.

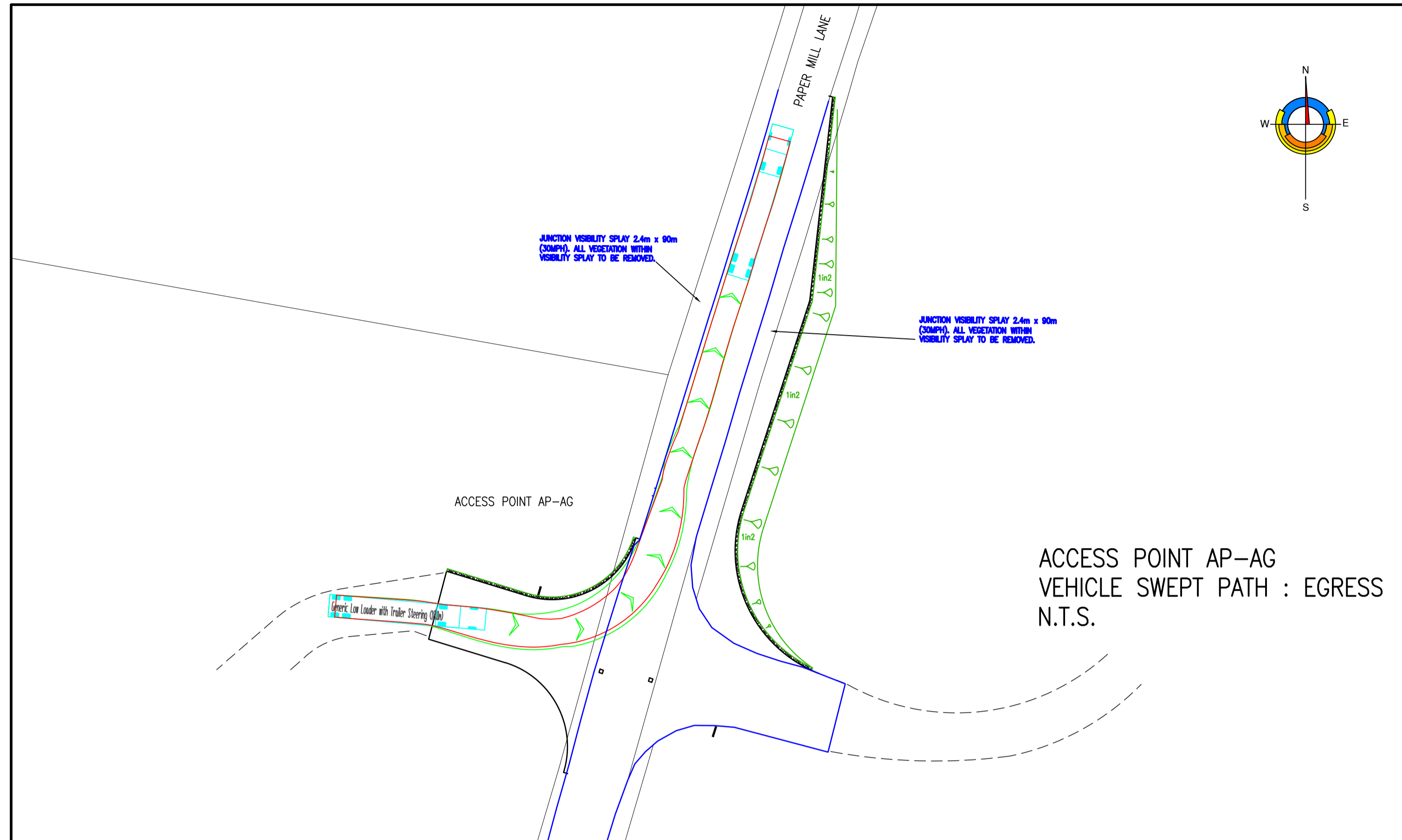
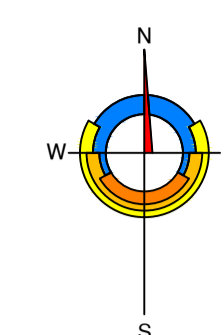

ACCESS POINT AP-AG
VEHICLE SWEEP PATH : EGRESS
N.T.S.

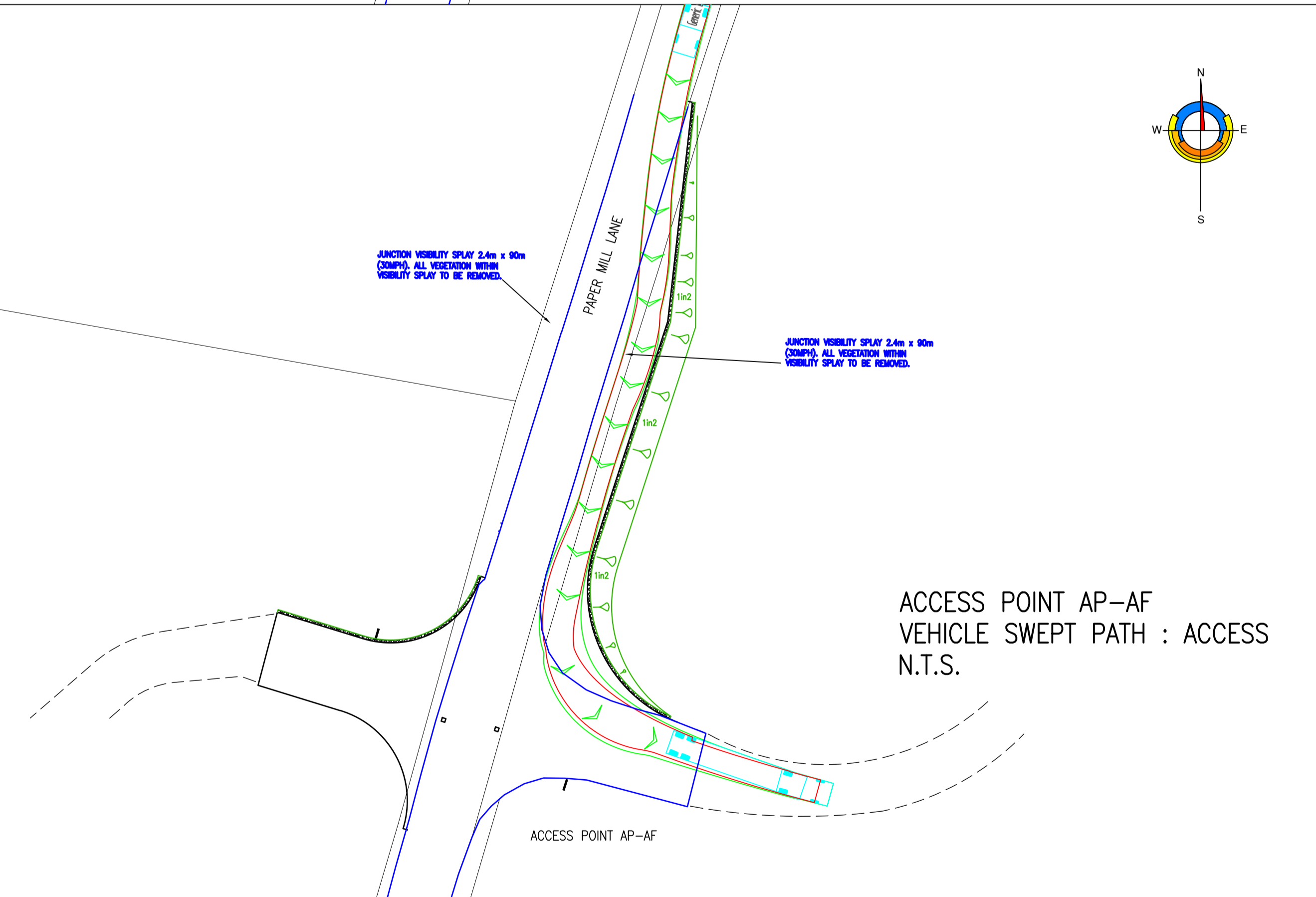
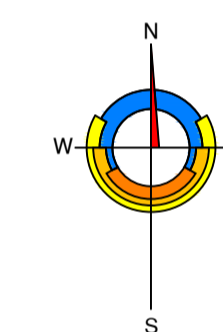

ACCESS POINT AP-AF
VEHICLE SWEEP PATH : ACCESS
N.T.S.

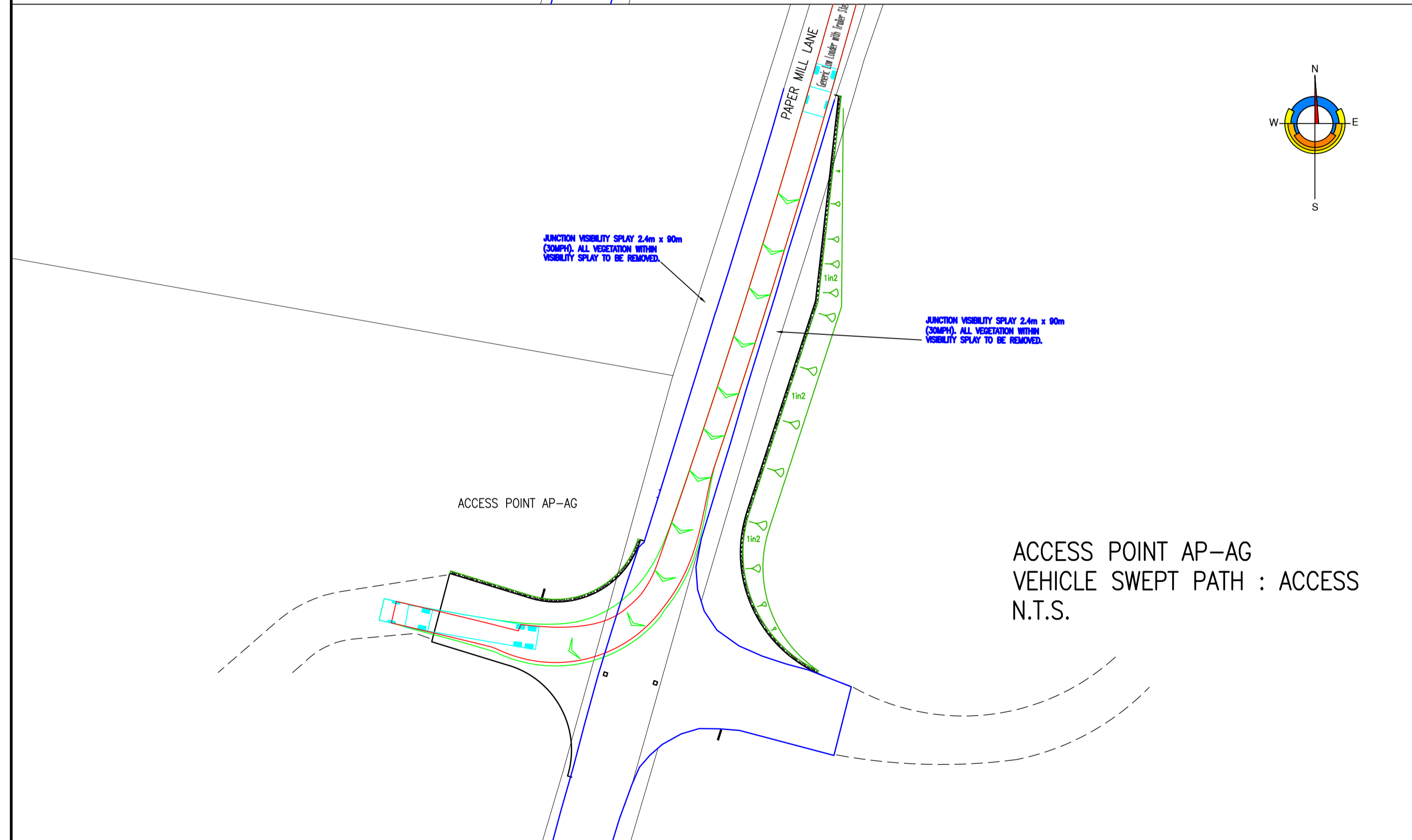
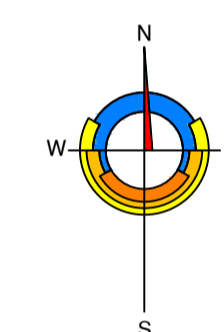

ACCESS POINT AP-AG
VEHICLE SWEEP PATH : ACCESS
N.T.S.

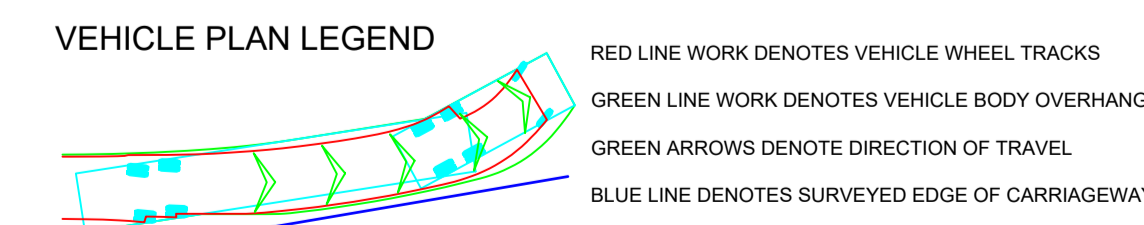
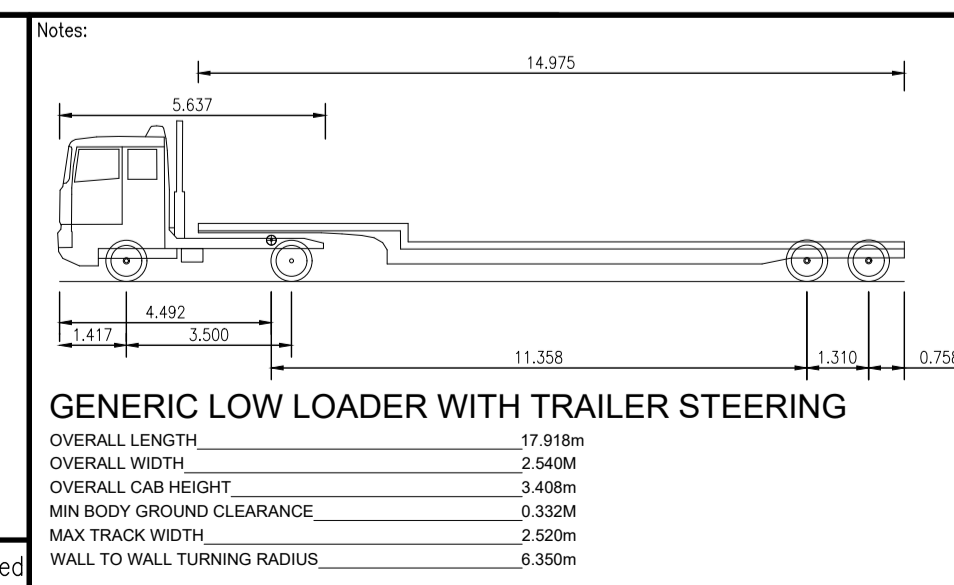

Rev.	Date	Description	Drawn	Checked	Approved

	Project Title: EA3 HVDC ROUTE PRE-COMMENCEMENT WORKS TRANSPORT ASSESSMENT		
	Drawing Title: SWEPT PATH ANALYSIS ACCESS POINTS AP-AF AND AP-AG	Scale at A1: Not to scale	Status: FOR APPROVAL
	Drawn: Date: 17/03/22	Checked: Date: 17/03/22	Approved: Date: 17/03/22
Drawing No.: 146103/1012		Revision: -	

NOTE:
THE PHOTOGRAPH OPPOSITE SHOWS THE WHEEL TRACKS ON BEALINGS ROAD AS A RESULT OF TRAFFIC MOVEMENTS IN AND OUT OF THE FORMER AX-08 JUNCTION USED DURING THE EA1 PROJECT, WHICH IS BEING REINSTATED TO THE EXACT SAME STANDARD FOR THIS EA3 PROJECT.

THE EXISTING BT POLE WITHIN THE NORTHERN VERGE OF BEALINGS ROAD IS SUITABLY DISTANCE FROM THE EXTENT OF THE LOW-LOADER VEHICLE SWEEP PATH, WHICH NEGATES THE REQUIREMENTS FOR ADDITIONAL PROTECTION MEASURES.

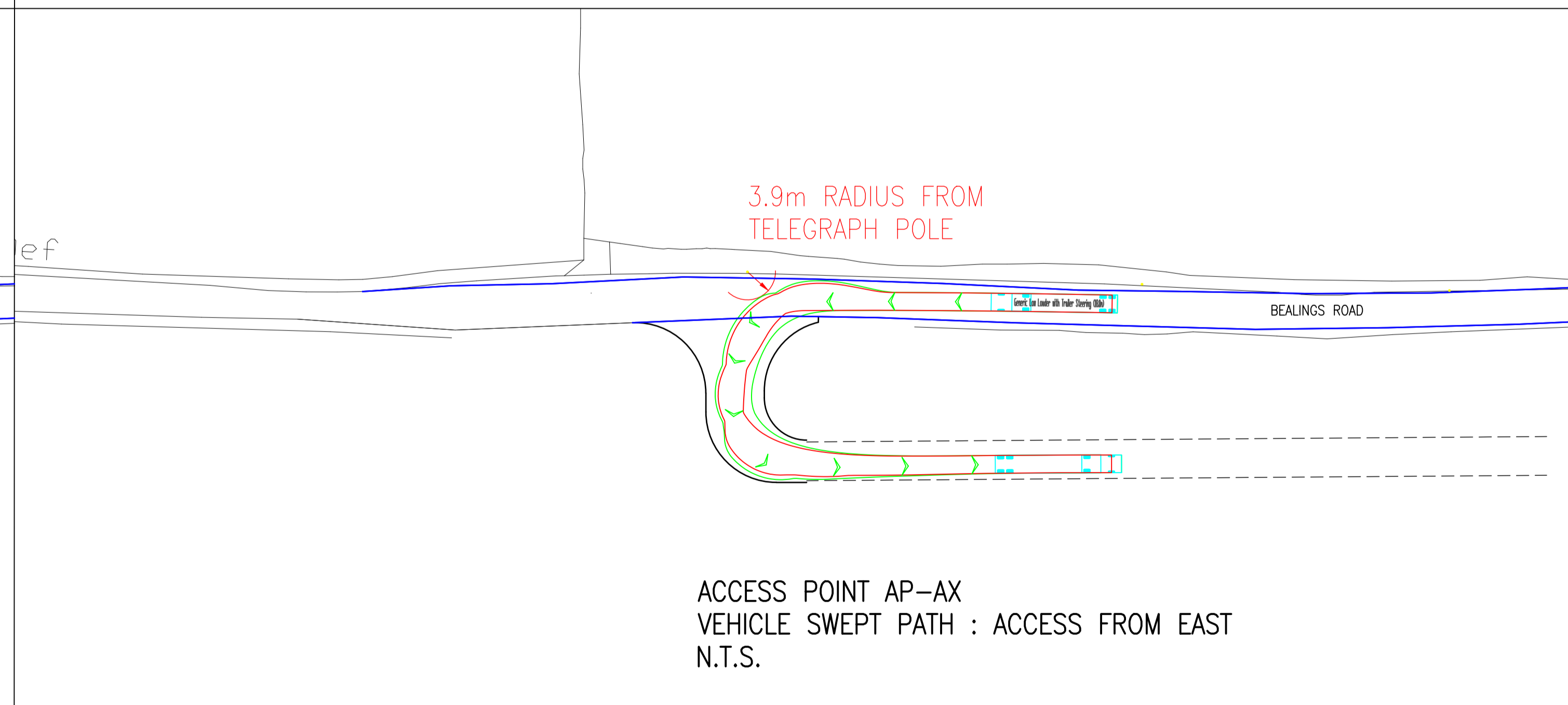
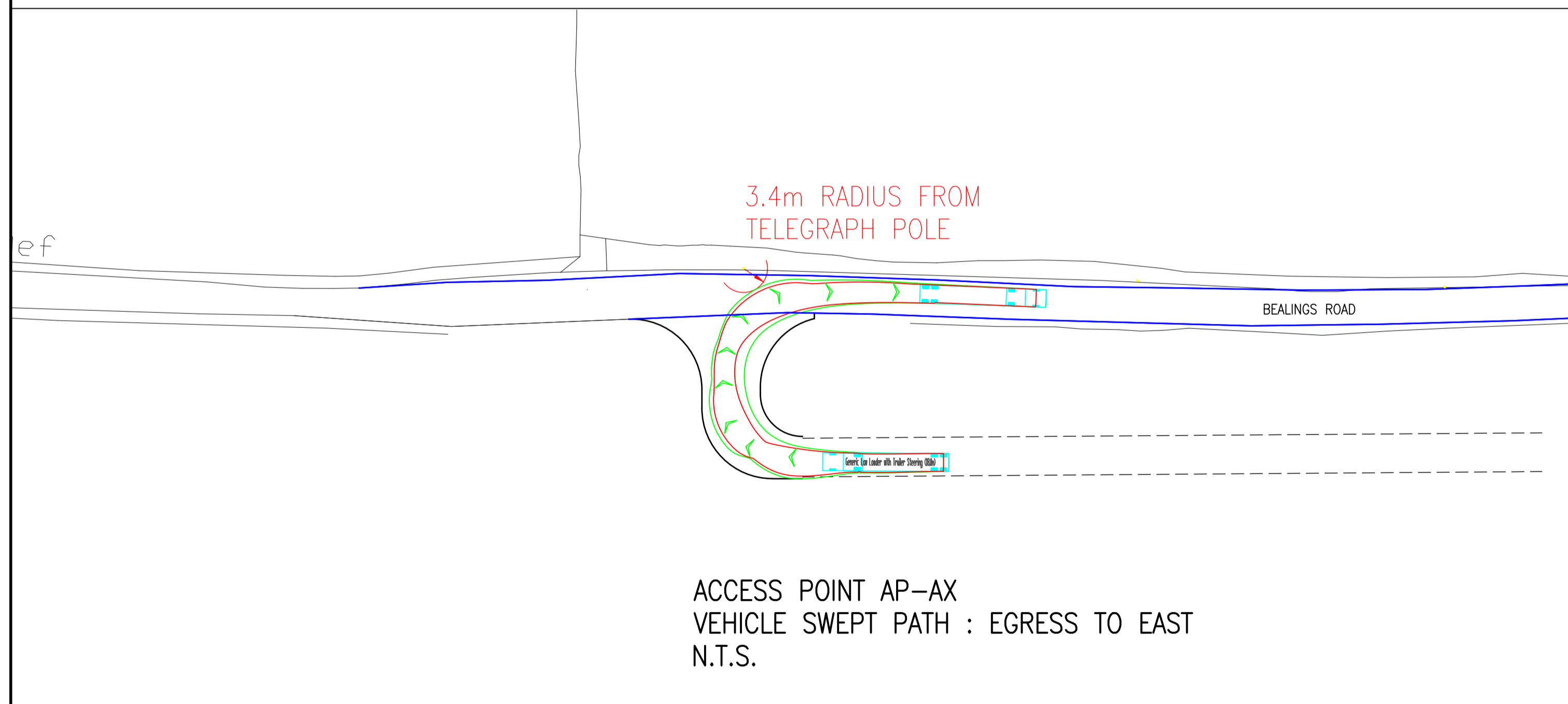
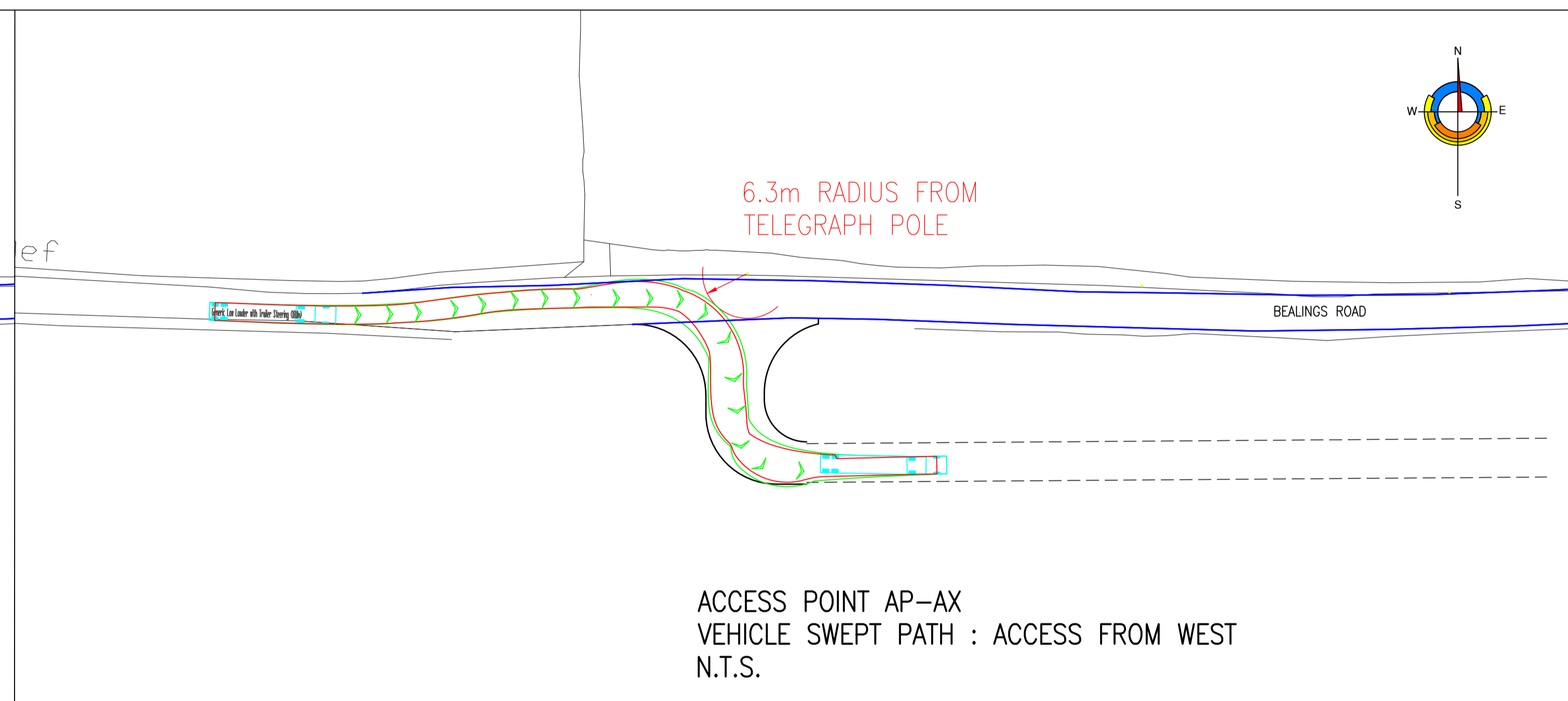
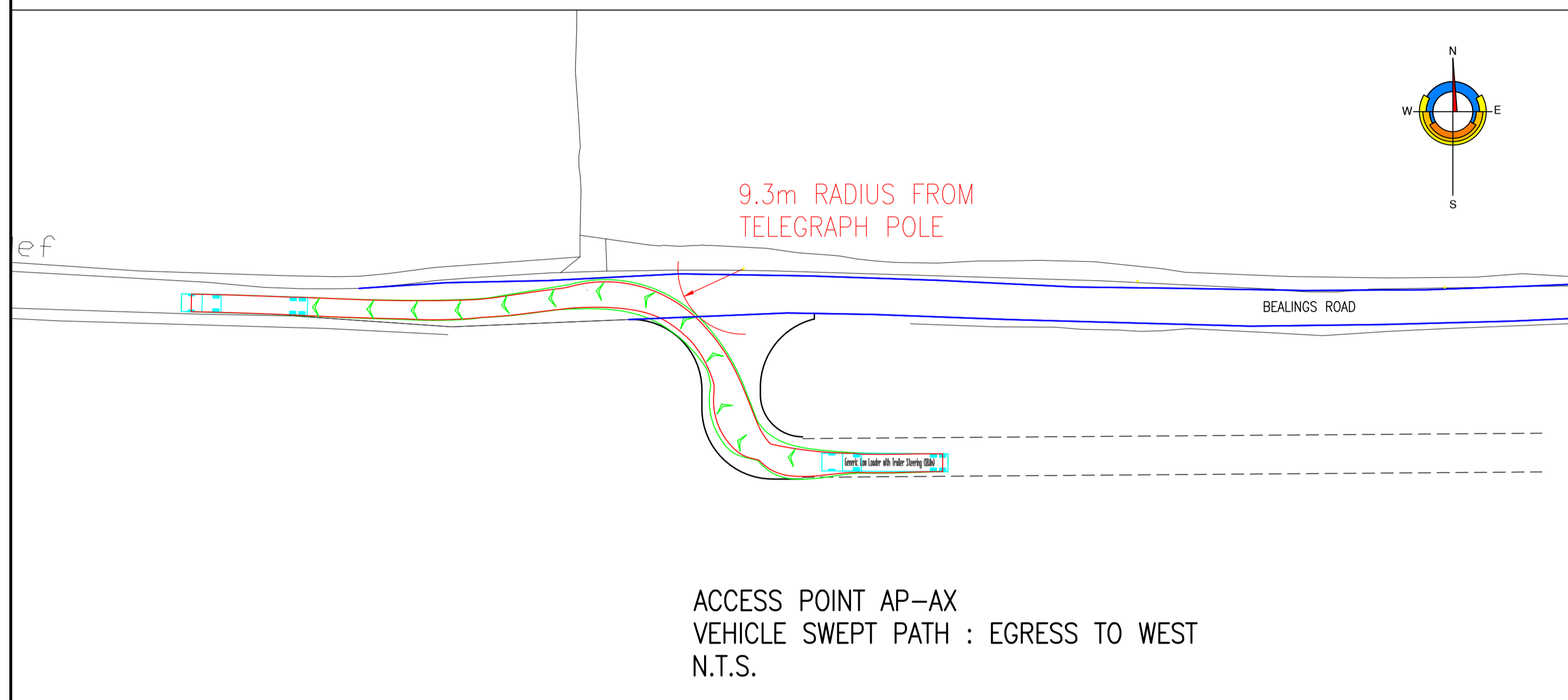

Rev.	Date	Description	Drawn	Checked	Approved
B	05.04.22	INFORMATION RELATING TO EXISTING TELEGRAPH POLE IN NORTHERN VERGE OF BEALINGS ROAD ADDED.	ACM	GAV	SGD
A	24.3.22	ACCESS AND EGRESS TO AND FROM THE EAST NOW SHOWN.	ACM	GAV	SGD

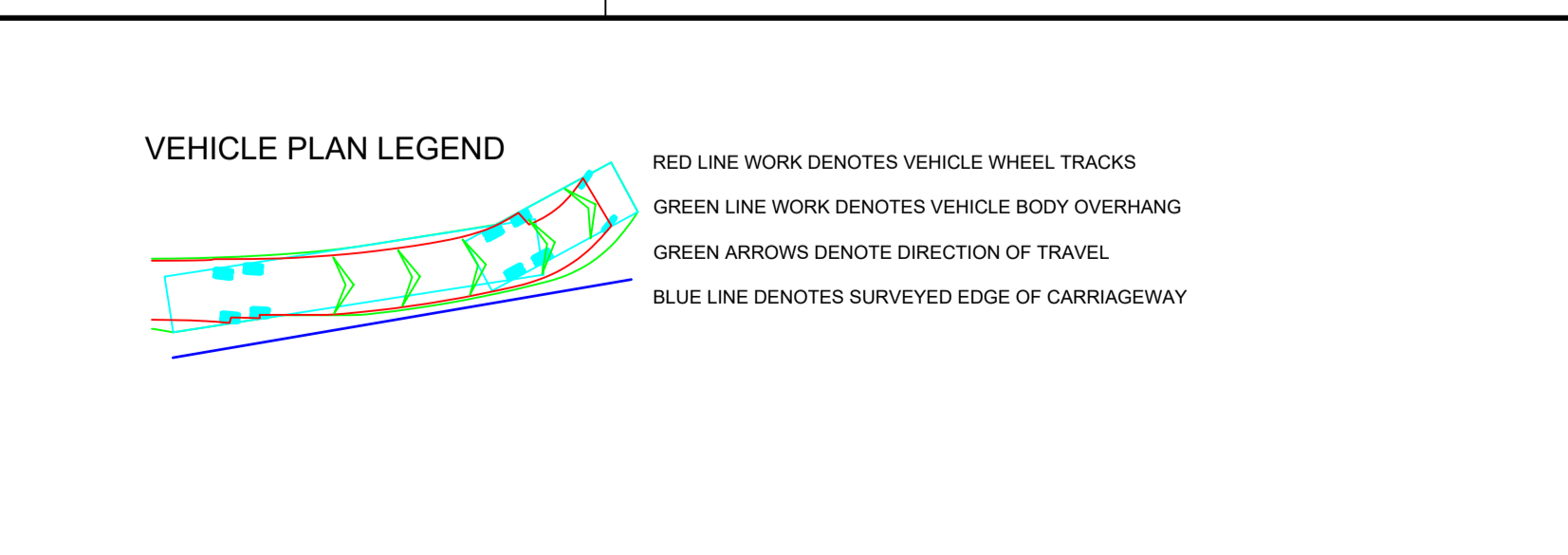
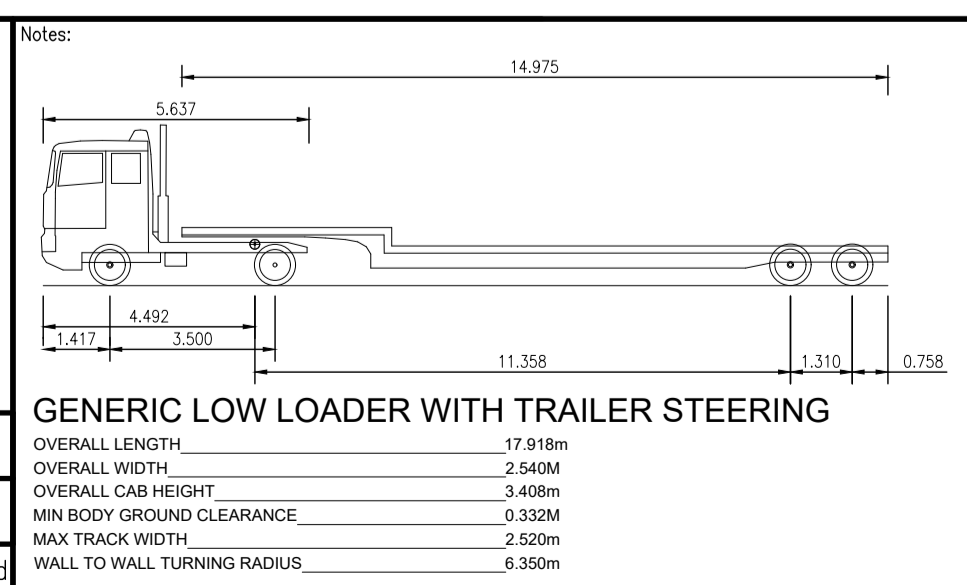

Client:

Project Title:

EA3 HVDC ROUTE
PRE-COMMENCEMENT WORKS
TRANSPORT ASSESSMENT

Drawing Title:
SWEEP PATH ANALYSIS
ACCESS POINT AP-X

FAIRHURST

Westerton of Craigie,
Southampton Road, DUNDEE, DD4 7PN
Tel: 01382 453300 Fax: 0844 381 4412

Scale at A1: Not to scale	Status: FOR APPROVAL	
Drawn: ACM	Checked: GAV	Approved: SGD
Date: 17/03/22	Date: 17/03/22	Date: 17/03/22
Drawing No.: 146103/1013	Revision: B	

Do not scale from this drawing.

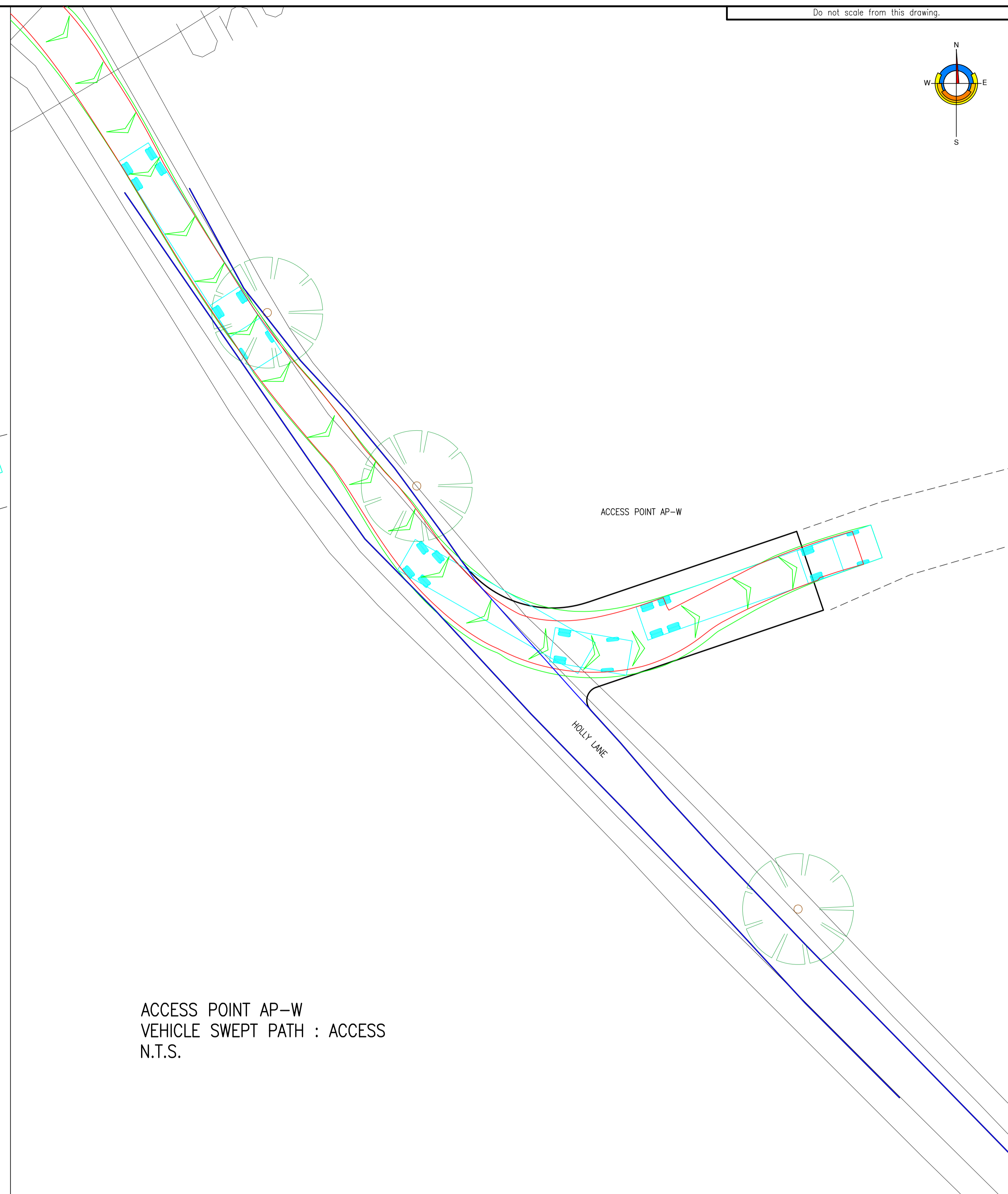
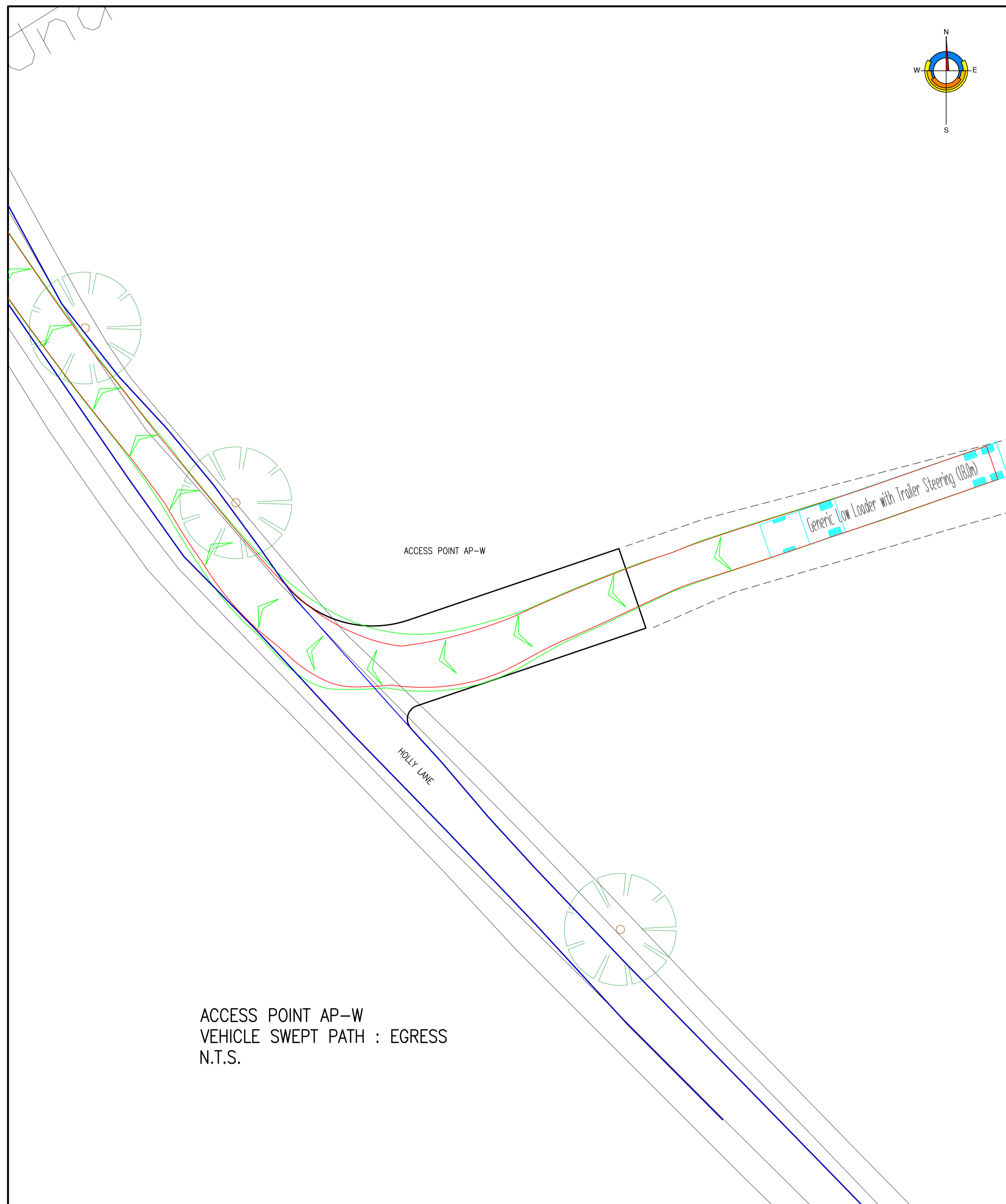
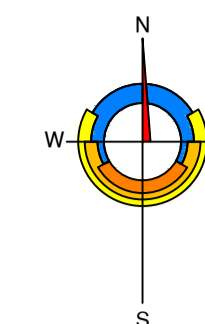
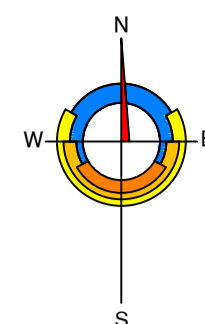

ACCESS POINT AP-W
VEHICLE SWEEP PATH : EGRESS
N.T.S.

ACCESS POINT AP-W
VEHICLE SWEEP PATH : ACCESS
N.T.S.

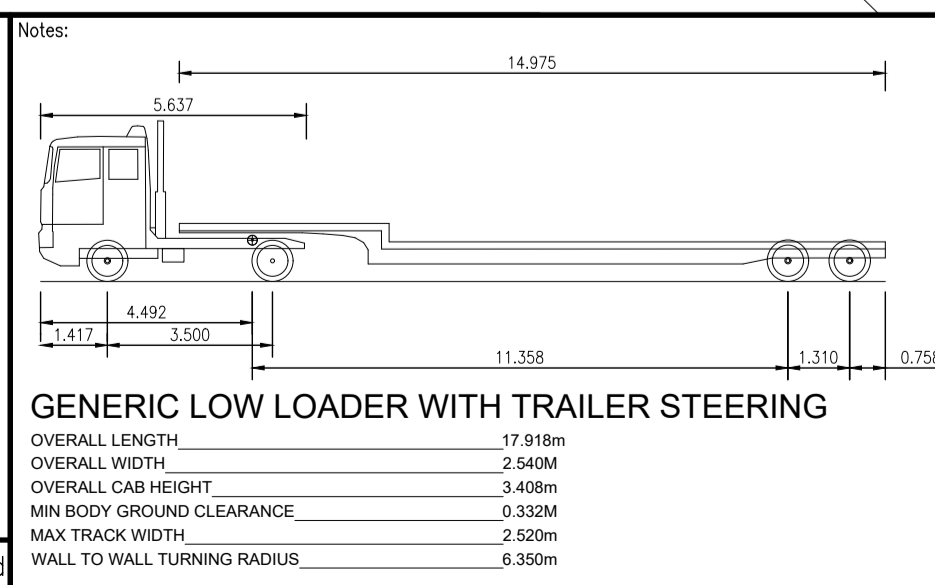

VEHICLE PLAN LEGEND

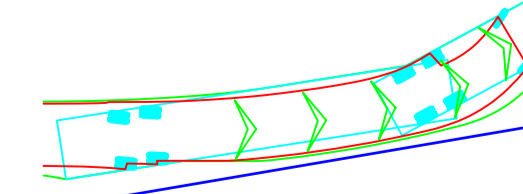

- RED LINE WORK DENOTES VEHICLE WHEEL TRACKS
- GREEN LINE WORK DENOTES VEHICLE BODY OVERHANG
- GREEN ARROWS DENOTE DIRECTION OF TRAVEL
- BLUE LINE DENOTES SURVEYED EDGE OF CARRIAGEWAY

Rev.	Date	Description	Drawn	Checked	Approved

Client:

Project Title:
**EA3 HVDC ROUTE
PRE-COMMENCEMENT WORKS
TRANSPORT ASSESSMENT**

Drawing Title:
**SWEPT PATH ANALYSIS
ACCESS POINTS AP-W**

FAIRHURST

Westerton of Craigie,
Southampton Road, DUNDEE, DD4 7PN
Tel: 01382 453300 Fax: 0844 381 4412

Scale at A1: Not to scale	Status: FOR APPROVAL	
Drawn: ACM	Checked: GAV	Approved: SGD
Date: 17/03/22	Date: 17/03/22	Date: 17/03/22
Drawing No.: 146103/1014		Revision: -

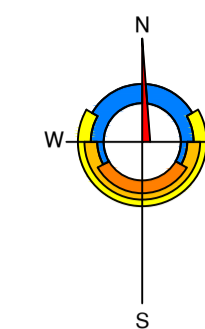
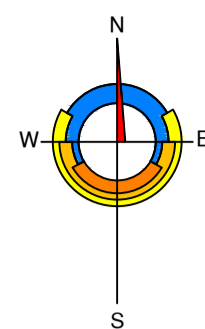

JUNCTION VISIBILITY SPLAY 2.4m x 90m
(30MPH). ALL VEGETATION WITHIN
VISIBILITY SPLAY TO BE REMOVED.

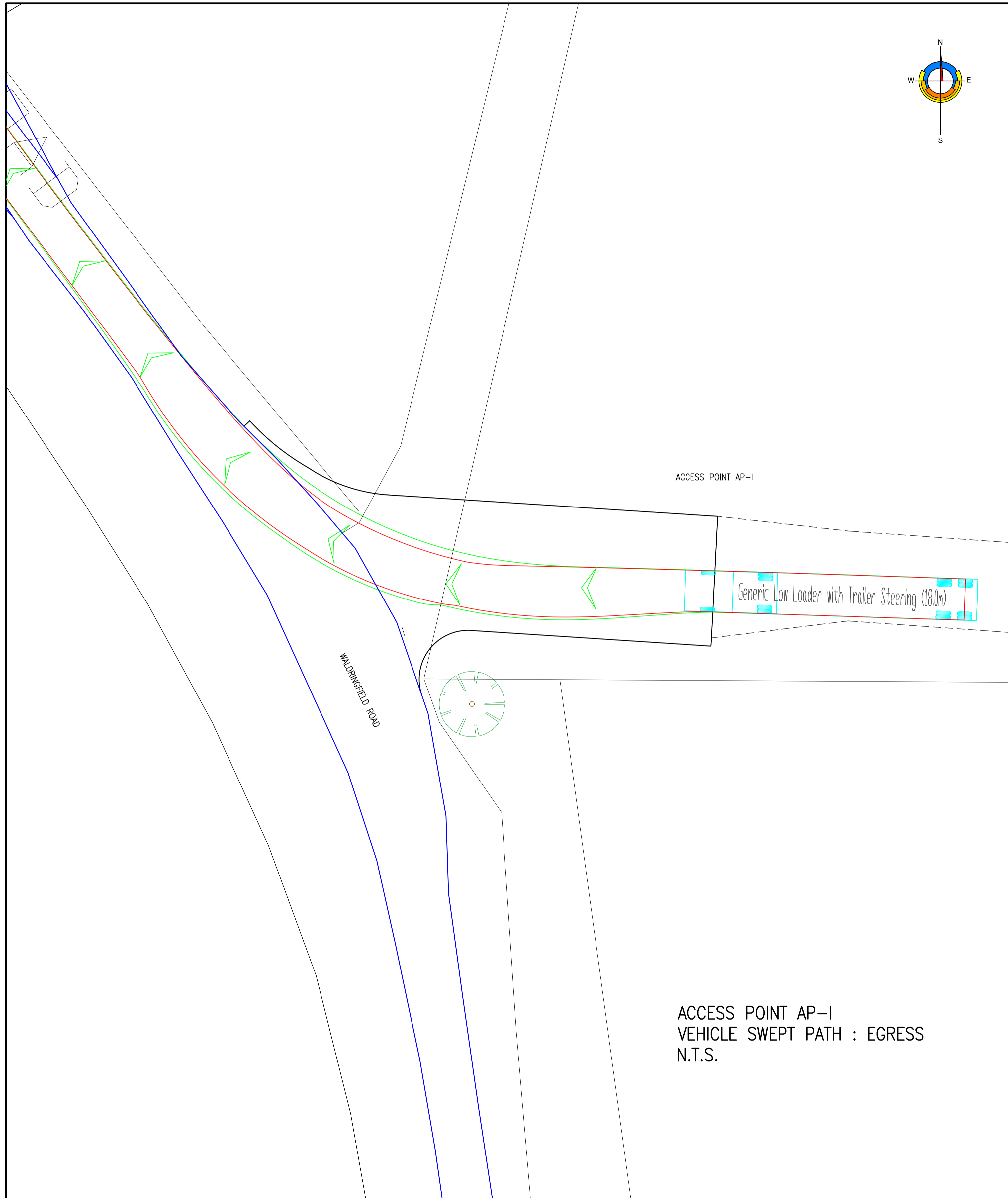

ACCESS POINT AP-1

Generic Low Loader with Trailer Steering (18.0m)

WILDRINGFIELD ROAD

ACCESS POINT AP-1
VEHICLE SWEEP PATH : EGRESS
N.T.S.

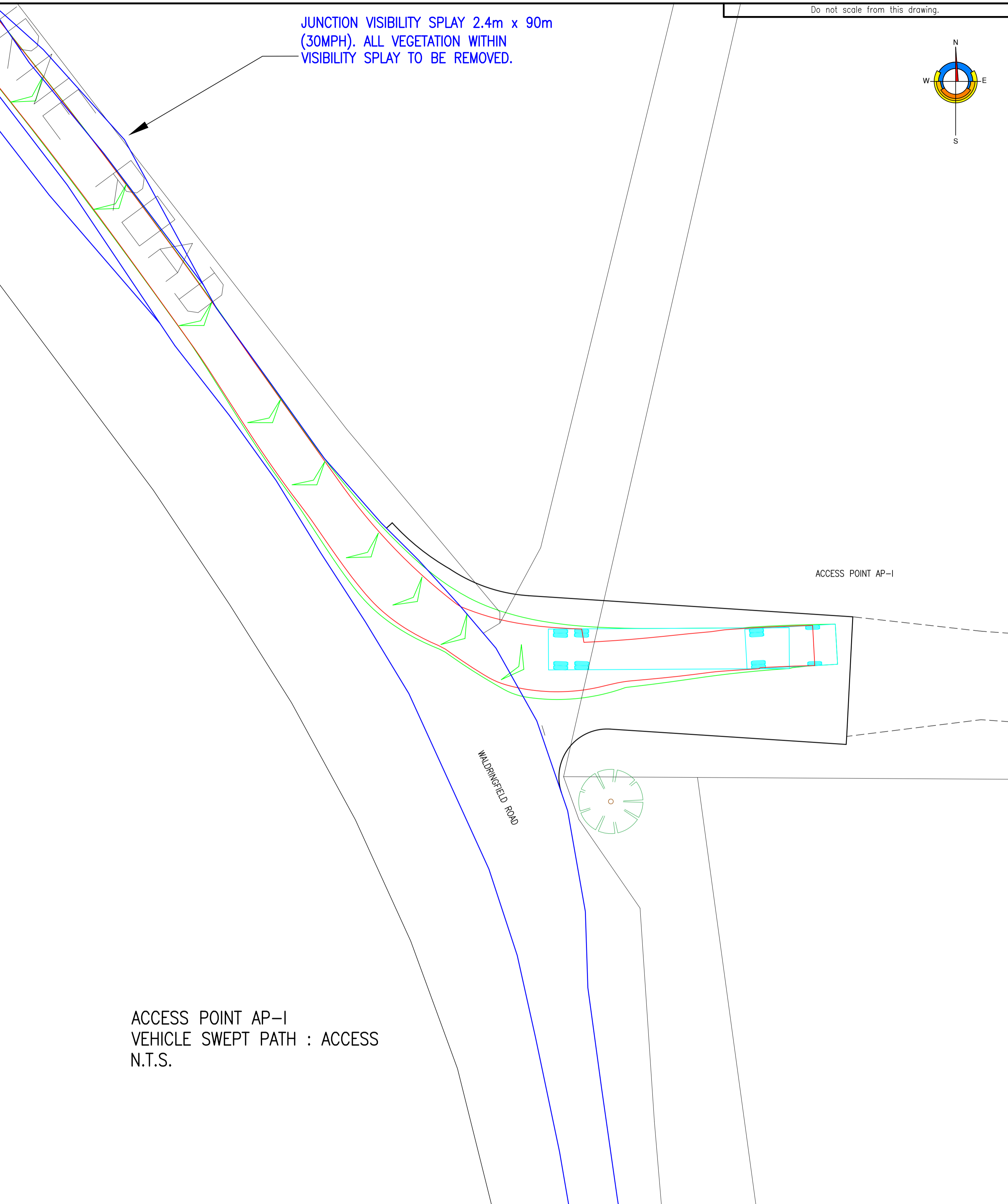

ACCESS POINT AP-1

WILDRINGFIELD ROAD

ACCESS POINT AP-1
VEHICLE SWEEP PATH : ACCESS
N.T.S.

Rev.	Date	Description	Drawn	Checked	Approved

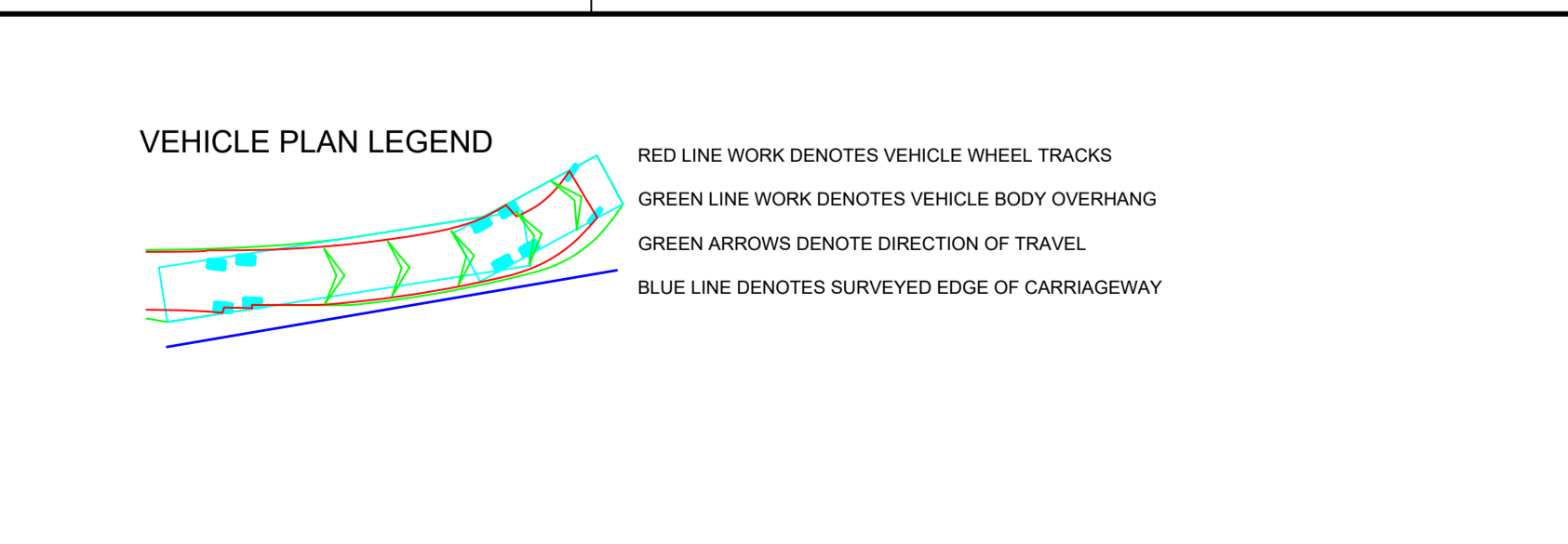
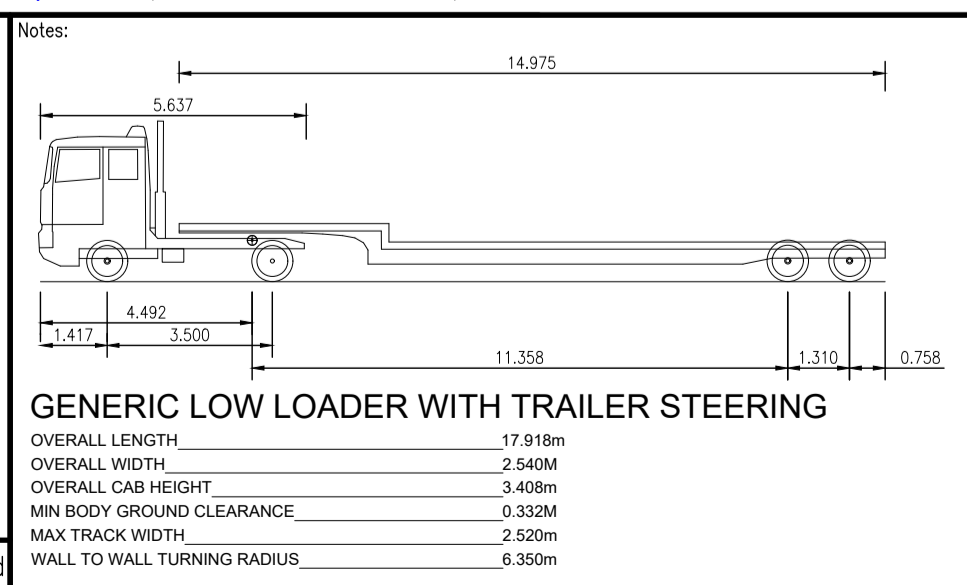

Client:

Project Title:
**EA3 HVDC ROUTE
PRE-COMMENCEMENT WORKS
TRANSPORT ASSESSMENT**

Drawing Title:
**SWEEP PATH ANALYSIS
ACCESS POINTS AP-1**

FAIRHURST

Westerton of Craigie,
Southampton Road, DUNDEE, DD4 7PN
Tel: 01382 453300 Fax: 0844 381 4412

Scale at A1: Not to Scale	Status: FOR APPROVAL	
Drawn: ACM	Checked: GAV	Approved: SGD
Date: 17/03/22	Date: 17/03/22	Date: 17/03/22
Drawing No.: 146103/1015		Revision: -

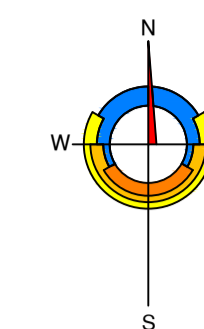
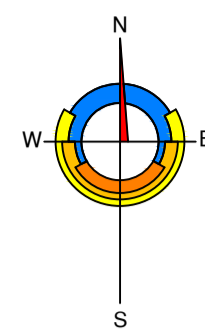

BLUE LINE WORK DENOTES THE EDGE OF EXISTING CARRIAGEWAY OBTAINED BY TOPOGRAPHIC SURVEY DATED 04 NOVEMBER 2021.
THE SWEEP PATH ANALYSIS INDICATES THAT FOR THE WORST CASE VEHICLE (LOW-LOADER), THE WHEEL TRACKS ARE CONTAINED WITH THE CARRIAGEWAY SURFACING, WITH NO IMPACT ON THE PRIVATE ACCESS DIRECTLY OPPOSITE ACCESS POINT AP-H.

BLUE LINE WORK DENOTES THE EDGE OF EXISTING CARRIAGEWAY OBTAINED BY TOPOGRAPHIC SURVEY DATED 04 NOVEMBER 2021.
THE SWEEP PATH ANALYSIS INDICATES THAT FOR THE WORST CASE VEHICLE (LOW-LOADER), THE WHEEL TRACKS ARE CONTAINED WITH THE CARRIAGEWAY SURFACING, WITH NO IMPACT ON THE PRIVATE ACCESS DIRECTLY OPPOSITE ACCESS POINT AP-H.

ACCESS POINT AP-H

ACCESS POINT AP-H

ACCESS POINT AP-AH
VEHICLE SWEEP PATH : EGRESS
N.T.S.

ACCESS POINT AP-AH
VEHICLE SWEEP PATH : ACCESS
N.T.S.

NEBOURNE ROAD

NEBOURNE ROAD

Rev.	Date	Description	Drawn	Checked	Approved
B	06.04.22	NOTES REGARDING EXTENT OF TOPOGRAPHIC SURVEY ADDED, ALONG WITH CONFIRMING SWEEP PATH ANALYSIS DOES NOT IMPACT PRIVATE ACCESSES	ACM	GAV	SGD
A	24.03.22	EXISTING SERVICES INFORMATION REMOVED FROM DRAWING FOR CLARITY.	ACM	GAV	SGD

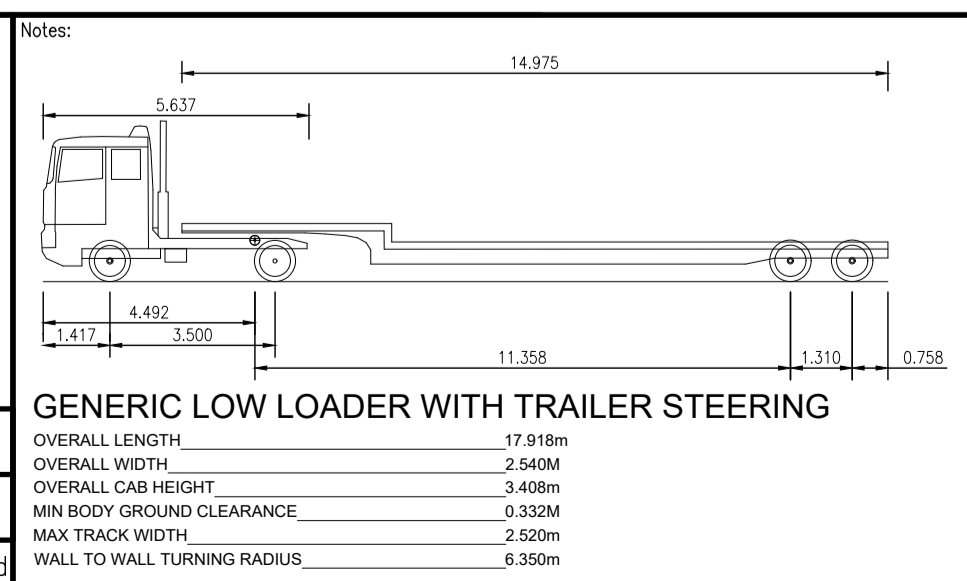

VEHICLE PLAN LEGEND

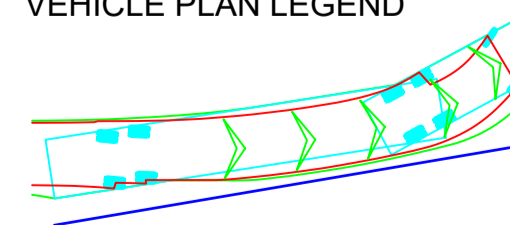

RED LINE WORK DENOTES VEHICLE WHEEL TRACKS
GREEN LINE WORK DENOTES VEHICLE BODY OVERHANG
GREEN ARROWS DENOTE DIRECTION OF TRAVEL
BLUE LINE DENOTES SURVEYED EDGE OF CARRIAGEWAY

Client:



Project Title:

EA3 HVDC ROUTE
PRE-COMMENCEMENT WORKS
TRANSPORT ASSESSMENT



Drawing Title:

SWEEP PATH ANALYSIS
ACCESS POINTS AP-H

FAIRHURST

Westerton of Craigie,
Southampton Road, DUNDEE, DD4 7PN
Tel: 01382 453300 Fax: 0844 381 4412

Scale at A1: Not to scale
Status: FOR APPROVAL

Drawn: ACM	Checked: GAV	Approved: SGD
Date: 17/03/22	Date: 17/03/22	Date: 17/03/22

Drawing No.: 146103/1016
Revision: B

APPENDIX 2

146103-DOC-04 Method Statement for Traffic Control at Holly Lane

Project: East Anglia Three HV Cable Installation Highway Works	Job No.	146103
	Document Number	146103-DOC-04
	Prepared by/Date	ACM/13.04.2022
	Checked by/Date	GAV/13.04.2022
	Approved by/Date	GLB/13.04.2022

METHOD STATEMENT FOR THE TEMPORARY TRAFFIC CONTROL AT HOLLY LANE (AP-W).

The following Method Statement has been prepared in support of the application to Suffolk County Council for the construction of a new access junction off Holly Lane, in order to gain access for construction vehicles associated with the HV Cable installation for the East Anglia Three project.

Holly Lane is a rural two way road with low traffic volumes and is currently the subject of the national speed limit. There are grass verges to both sides of the road in the vicinity of the new access and no pedestrian footpaths. Pedestrians currently walk either on the verges where suitable or within the public carriageway.

The construction of access junction AP-W, off Holly Lane, has a requirement to retain the existing mature trees in the vicinity from an environmental perspective. Retention of the trees significantly reduces the junction visibility when exiting site.

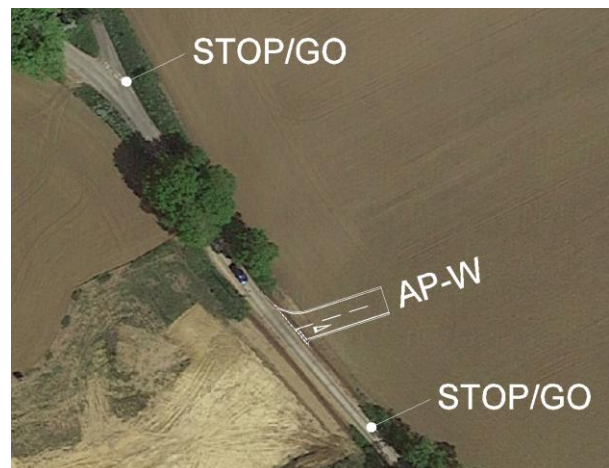

In order to mitigate against the reduced visibility upon exit from junction AP-W, a temporary traffic control system is being proposed, in the form of manually operated STOP/GO boards. The use of the STOP/GO boards will only be required for vehicles leaving the site access and turning right onto Holly Lane. No vehicles will be permitted to turn left out of AP-W.

For construction vehicles exiting junction AP-W, signage will be in place to highlight the requirements for drivers to stop at the junction and await further instruction to proceed once the STOP/GO system has been deployed, and they receive clear instruction from the operatives of the STOP/GO system that it is clear to exit.

The construction vehicle movements out of junction AP-W will be limited in number and sporadic. It is therefore proposed that vehicle movements are programmed so that operatives of the STOP/GO system are present.

Prior to implementing the STOP/GO system, Holly Lane will have the current speed limit reduced to 30mph, which will be instigated through a TTRO application to Suffolk County Council. In addition, advance warning signage will have been erected to warn road users of the presence of construction vehicles.

The live carriageway of any road is a dangerous environment in which to work. In particular, during the periods when traffic management arrangements are being set up, changed, maintained or removed, operatives will need to work on the live carriageway without the protection afforded by the fully installed layouts. This is particularly relevant on Holly Lane, as no footpaths are present. Only appropriately trained and competent operatives, supervisors, managers or other competent persons should be engaged in the, setting up, maintaining and removing of signing and temporary traffic control.

Due to the increased risk when setting up traffic management great care is needed to ensure that the operatives can see the traffic and the traffic can see them. High visibility clothing is to be worn at all times. When setting out the works, operatives should face oncoming traffic and keep to verges wherever possible. They should take particular care when crossing the road to place signs. They must not be distracted by mobile phones (including hands-free phones), radios, or other devices during the set-up operation.

The Department of Transport publication 'Safety at Street Works and Road Works' A Code of Practice, will be referred to for all information relating to the safe implementation and operation of this temporary traffic control. The 'Road Works Ahead' signs should be set up first. Using the appropriate diagrams in the aforementioned Code of Practice, operatives should work back towards the site, placing more signs as necessary again keeping to the verge wherever possible.

Manually operated STOP/GO boards are to be used in positions where the operator can be located in a position of safety. As the traffic management will only be implemented for the exit of a construction vehicle from AP-W, and then removed until required again, the use of remotely operated boards has been deemed as not appropriate.

Two STOP/GO boards will be in use each time. One to stop traffic on approach to AP-W from the south, and one to stop traffic on approach from the north. Operatives should remain in contact at all times using two-way radio communication. The operative showing 'Go' to oncoming traffic must always be the one to control the change of traffic flow. Adequate time must be allowed for vehicles to clear before the other board is reversed to show 'Go'.



On completion of the vehicles exit movement, operatives are to ensure that all signs are removed promptly. The signs should be taken down in reverse order to their erection ending with the 'Road works ahead' signs. Road Signs and STOP/GO boards should be stored in a secure container, located inside the site access gate.

Summary of Temporary Traffic Control

- Timings of vehicle movement existing the site are to be programmed.
- Erect additional signage in accordance with the 'Safety at Street Works and Road Works' Code of Practice.
- Deploy the STOP/GO boards.
- Once all construction traffic has left junction AP-W, remove all signage and STOP/GO boards and store in container at site access gate

Refer to 146103/FIGURE 1 for the arrangement of the STOP/GO boards to the north side of access point AP-W

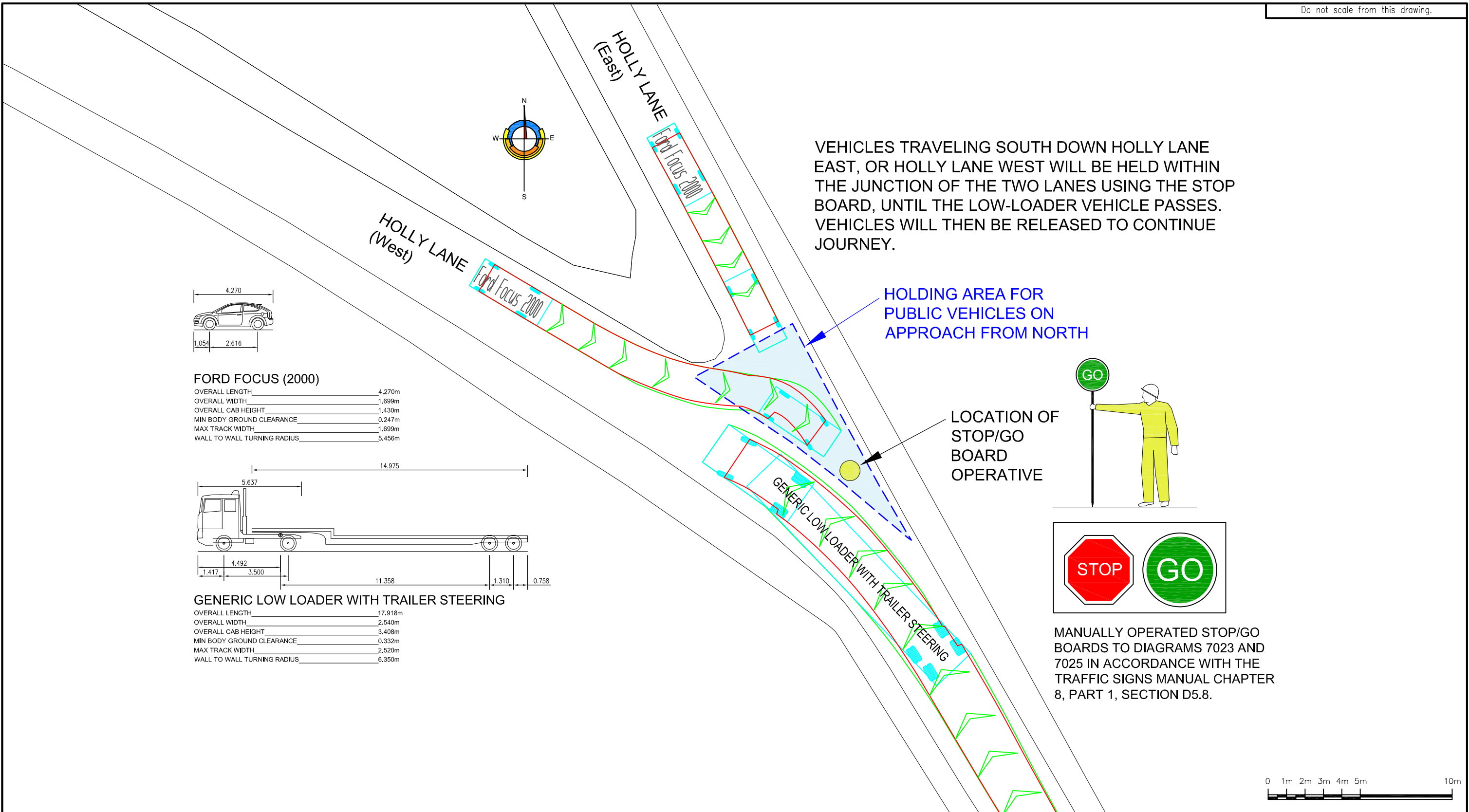

VEHICLES TRAVELING SOUTH DOWN HOLLY LANE EAST, OR HOLLY LANE WEST WILL BE HELD WITHIN THE JUNCTION OF THE TWO LANES USING THE STOP BOARD, UNTIL THE LOW-LOADER VEHICLE PASSES. VEHICLES WILL THEN BE RELEASED TO CONTINUE JOURNEY.

HOLDING AREA FOR PUBLIC VEHICLES ON APPROACH FROM NORTH

LOCATION OF STOP/GO BOARD OPERATIVE

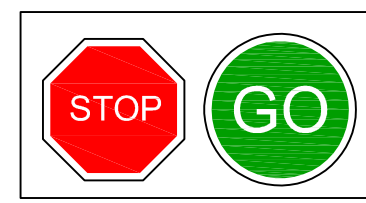
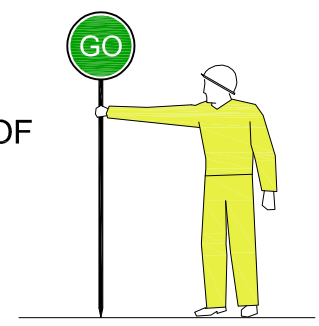

MANUALLY OPERATED STOP/GO BOARDS TO DIAGRAMS 7023 AND 7025 IN ACCORDANCE WITH THE TRAFFIC SIGNS MANUAL CHAPTER 8, PART 1, SECTION D5.8.

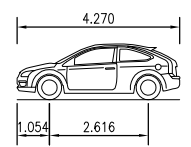

FORD FOCUS (2000)

OVERALL LENGTH	4.270m
OVERALL WIDTH	1.699m
OVERALL CAB HEIGHT	1.430m
MIN BODY GROUND CLEARANCE	0.247m
MAX TRACK WIDTH	1.699m
WALL TO WALL TURNING RADIUS	5.456m

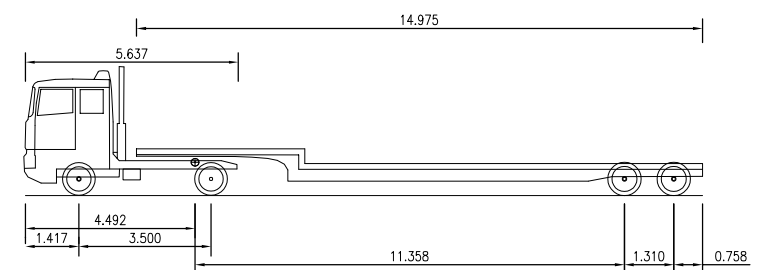

GENERIC LOW LOADER WITH TRAILER STEERING

OVERALL LENGTH	17.918m
OVERALL WIDTH	2.540m
OVERALL CAB HEIGHT	3.408m
MIN BODY GROUND CLEARANCE	0.332m
MAX TRACK WIDTH	2.520m
WALL TO WALL TURNING RADIUS	6.350m

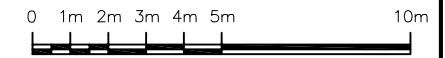

Rev.	Date	Description	Drawn	Checked	Approved

Notes:
THIS FIGURE IS TO BE READ IN CONJUNCTION WITH THE METHOD STATEMENT 146103-DOC-04



Client:
Project Title:
EA3 HVDC ROUTE
PRE-COMMENCEMENT WORKS
TRANSPORT ASSESSMENT

Drawing Title:
STOP/GO BOARD ARRANGEMENT
TO NORTH SIDE OF ACCESS
POINT AP-W, HOLLY LANE.



Westerton of Craigie,
Southampton Road, DUNDEE, DD4 7PN
Tel: 01382 453300 Fax: 0844 381 4412

Scale at A3: 1:200	Status: For Approval
Drawn: GAV	Checked: ACM
Date: 13/04/22	Date: 13/04/22
Approved: GLB	Date: 13/04/22

Drawing No.:
146103/FIGURE 1

CIVIL ENGINEERING • STRUCTURAL ENGINEERING • TRANSPORTATION • ROADS & BRIDGES
PORTS & HARBOURS • GEOTECHNICAL & ENVIRONMENTAL ENGINEERING • PLANNING &
DEVELOPMENT • WATER SERVICES • HEALTH & SAFETY / CDM SERVICES

www.fairhurst.co.uk

Aberdeen	Leeds
Birmingham	London
Bristol	Newcastle upon Tyne
Dundee	Plymouth
Edinburgh	Sevenoaks
Elgin	Taunton
Glasgow	Thurso
Huddersfield	Watford
Inverness	Westhill

FAIRHURST

**APPENDIX 2 EAST ANGLIA THREE CONVERTER STATION AND PAPER MILL LANE
WORKS TRAFFIC AND TRANSPORT TECHNICAL NOTE**

FOR DISCHARGE

EAST ANGLIA THREE PLAYFORD CORNER WORKS AND CLAPPITS WORKS

Traffic and Transport Technical Note
Prepared for: **ScottishPower Renewables**

SLR Ref: 404.05356.00006
Version No: Final
March 2022



BASIS OF REPORT

This document has been prepared by SLR with reasonable skill, care and diligence, and taking account of the manpower, timescales and resources devoted to it by agreement with ScottishPower Renewables (the Client) as part or all of the services it has been appointed by the Client to carry out. It is subject to the terms and conditions of that appointment.

SLR shall not be liable for the use of or reliance on any information, advice, recommendations and opinions in this document for any purpose by any person other than the Client. Reliance may be granted to a third party only in the event that SLR and the third party have executed a reliance agreement or collateral warranty.

Information reported herein may be based on the interpretation of public domain data collected by SLR, and/or information supplied by the Client and/or its other advisors and associates. These data have been accepted in good faith as being accurate and valid.

The copyright and intellectual property in all drawings, reports, specifications, bills of quantities, calculations and other information set out in this report remain vested in SLR unless the terms of appointment state otherwise.

This document may contain information of a specialised and/or highly technical nature and the Client is advised to seek clarification on any elements which may be unclear to it.

Information, advice, recommendations and opinions in this document should only be relied upon in the context of the whole document and any documents referenced explicitly herein and should then only be used within the context of the appointment.

CONTENTS

1.0	INTRODUCTION	1
1.1	Background	1
1.2	Purpose of the Report.....	1
2.0	DCO SUBMISSION PLAYFORD CORNER AND CLAPPITS WORKS TRAFFIC DATA	2
2.1	Assessment Assumptions.....	2
2.2	Assessment Requirements.....	2
3.0	CONFIRMED PLAYFORD CORNER WORKS AND CLAPPITS WORKS TRAFFIC DATA	4
3.1	Introduction	4
3.2	Trip Generation.....	4
3.3	Trip Distribution	4
3.4	Assessment Scenarios	5
4.0	ASSESSMENT OF LIKELY IMPACTS.....	7
4.1	Introduction	7
4.2	Assessment Parameters.....	7
4.3	Traffic Flows.....	8
4.4	Capacity Assessments	8
4.4.1	Junction 5: Roundabout junction of the A12 and A1214	8
4.4.2	Junction 6: Roundabout junction of the A12/Newbourne Road	9
4.4.3	Capacity Assessment Summary	10
5.0	ROAD SAFETY ASSESSMENT REVIEW	11
5.1	Scope	11
5.2	Analysis	11
5.2.1	A12/B1079	11
5.2.2	A12/B1438	12
5.2.3	A12/ A1214	12
5.2.4	A12/Newbourne Road.....	12
5.2.5	Routes from the A12	13
5.3	Summary.....	13
6.0	SUMMARY AND CONCLUSION	14
6.1	Summary.....	14
6.2	Conclusion.....	14

DOCUMENT REFERENCES

TABLES

Table 2-1: Forecast Evening Peak (17:00 – 18:00) Junction Impacts (ES)	3
Table 3-1: EA THREE Confirmed Maximum Figures (NKT).....	4
Table 3-2: Traffic Distribution (ES)	4
Table 3-3: Forecast 17:00 to 18:00 Junction Impacts (Junction 5: A12/A1214)	5
Table 3-4: Forecast 17:00 to 18:00 Junction Impacts (Junction 6: A12/Newbourne Road)	5
Table 3-5: Forecast 17:00 to 18:00 Junction Impacts (Junction 8: B1079/Manor Road).....	6
Table 3-6: Forecast 17:00 to 18:00 Junction Impacts (Junction 11: A12/B1438).....	6
Table 4-1 Linsig Results (Junction 5: A12/A1214 - 17:00 to 18:00 – 2017 with No Park & Ride Stage)8	
Table 4-2 Linsig Results (Junction 5: A12/A1214 - 17:00 to 18:00).....	9
Table 4-3 ARCADY Results (Junction 6: A12/Newbourne Road - 17:00 to 18:00).....	9
Table 5-1 Road Safety Review on the EA THREE Construction Routes from the A12	13

APPENDICES

Appendix 01 NKT Vehicle Movements (including Sensitivity Tests)	
Appendix 02 Baseline Traffic Data	
Appendix 03 Committed Development Traffic	
Appendix 04 Assessment Scenario Traffic Flows	
Appendix 05 Linsig Results (A12/A1214)	
Appendix 06 ARCADY Results (A12/Newbourne Road)	
Appendix 07 Crashmap Reports	

1.0 Introduction

1.1 Background

SLR Consulting Ltd. (SLR) has been commissioned by ScottishPower Renewables (SPR) to undertake a review and analysis of the anticipated vehicle movements associated with the Playford Corner Works and the Clappits Works (and relevant onshore cable installation works Sections 1 - 7) stages of the East Anglia THREE Offshore Windfarm (EA THREE) construction works as per the Development Consent Order (DCO) dated 7th August 2017.

The forecast vehicle movements (personnel and Heavy Goods Vehicles (HGV)) associated with the construction of EA THREE onshore works were included in Chapter 27 'Traffic and Transport' of the Environmental Statement (ES), which was prepared by Royal HaskoningDHV in 2015 in support of the DCO submission (Document Reference – 6.1.27).

The vehicle movements identified in the ES were estimates based on a set of reasoned assumptions, professional experience and using previous project experience; however, following their appointment NKT, the Principal Contractor for the EA THREE cable route installation works has now confirmed the vehicle movements for the construction programme. These revised vehicle movements form the basis of the analysis presented in this Technical Note.

1.2 Purpose of the Report

The objective of this Technical Note is to provide Suffolk County Council (SCC) with an overview of the confirmed vehicle numbers associated with the Playford Corner Works and Clappits Works and the relevant cable installation works. It includes an assessment of the likely impacts at the required locations on the highway network in order to inform the discharge of DCO Requirements 16 and 27 with respect to the provision of an Access Management Plan, Traffic Management Plan and Travel Plan for each stage of the onshore works.

This Technical Note sets out the following:

- A summary of the assessment assumptions and requirements for EA THREE as identified in the ES;
- A comparison of the ES and NKT vehicle movements associated with the Playford Corner Works and the Clappits Works at the sensitive junctions on the highway network that are likely to be used by traffic associated with these works. This uses a lower vehicle occupancy for the NKT data than presented in the ES;
- A review of the likely impacts at the sensitive junctions on the highway network that are likely to be used by traffic associated with the Playford Corner Works and Clappits Works;
- A junction capacity assessment at the sensitive junctions forecast to experience an increase of 30 or more two-way vehicle movements in the evening peak hour associated with the Playford Corner Works and Clappits Works (Junction 5: Roundabout junction of the A12 and A1214 and Junction 6: Roundabout junction of the A12 and Newbourne Road); and
- An update of road safety analysis at key junctions on the highway network that are likely to be used by traffic associated with the Playford Corner Works and Clappits Works.

2.0 DCO Submission Playford Corner and Clappits Works Traffic Data

2.1 Assessment Assumptions

A brief summary of the assumptions used in the ES to assess the impact of all vehicle movements associated with the construction of EA THREE is set out as follows:

- The nature of construction works typically requires that employees work longer hours in the summer and shorter hours in the winter to take advantage of the available daylight. Employees would arrive prior to the morning network peak hour (08:00 to 09:00) throughout the year and therefore there is no requirement for assessment during this period). There is the possibility that there would be an overlap between construction employees departing the site at the end of the day and the network evening peak hour (17:00 to 18:00 observed from traffic counts), i.e. when the daytime construction shift finishes at the same time as the evening network peak. In this situation EA THREE employees would be departing the site and HGVs would be arriving at the Primary Construction Consolidation Sites (PCCSs).
- As a worst case it was assumed that all EA THREE employee trips would overlap with the evening network peak hour, recognising this scenario is only likely to occur during the months of November, December, January and February, when the sunsets at around 5pm, which would restrict (in most cases) construction working hours;
- The delivery of materials and plant to the Primary CCSs (Top Street) would be spread over a ten hour period, the onward deliveries to Secondary CCS (Playford Corner or Clappits) or points of access would be scheduled to avoid the highway network peak hours.
- A car occupancy of 2.5 employees per vehicle; and
- To develop a worst case impact scenario on the highway network, the peak traffic demand for each section was added together to create a theoretical 'in-combination worst case' week whereby the peak construction activity for all sections would occur concurrently. This results in the combined traffic flows on the 'A' class road network being over-estimated.

2.2 Assessment Requirements

In order to assess if there was any potential for significant impact the evening peak (17:00 to 18:00) on the highway network, the ES assumed that the EA THREE construction traffic was assigned to the junctions across the agreed study area.

SCC identified 11 junctions across the agreed study area as potentially being susceptible to increases in traffic flow.

In Chapter 27 'Traffic and Transport' it was concluded that the forecast vehicle movements associated with the construction of EA THREE (total construction works) were of a magnitude that could potentially lead to significant impacts at the following three sensitive junctions:

- Junction 1: Roundabout junction of the A14 and B1113 (Claydon Interchange);
- Junction 5: Roundabout junction of the A12 and A1214; and
- Junction 11: Roundabout junction of the A12 and B1438.

In the Outline Construction Traffic Management Plan (OCTMP), prepared for the EA THREE DCO application, the list of sensitive junctions where the forecast vehicle movements identified as having the potential to lead to significant impacts was as follows:

- Junction 5: Roundabout junction of the A12 and A1214;
- Junction 6: Roundabout junction of the A12 and Newbourne Road;
- Junction 8: Priority junction of the B1079 and Manor Road; and
- Junction 11: Roundabout junction of the A12 and B1438.

Capacity assessments were not undertaken at any of the junctions listed above (in Chapter 27 or the OCTMP) as part of the DCO application; however, the following strategy was proposed:

- The junctions identified as having the potential to lead to significant impacts would be subject to detailed analysis through the development of the Traffic Management Plan, post-consent, when a contractor has been appointed and can inform outcomes; and
- Further analysis would seek to quantify the potential significance of these impacts and the scope of mitigation measures. Potential mitigation measures would focus on enhanced travel planning and restricting peak hour movements rather than physical junction improvements.

The maximum vehicle movements in the evening peak hour at the sensitive junctions that would be used by the traffic associated with the Playford Corner Works and the Clappits Works and relevant cable installation works (sections 5, 6, 8 and 11) as identified in *Table 27.17 Peak Hour Traffic Flows through Sensitive Junctions* of Chapter 27 'Traffic and Transport', are set out in **Table 2-1**

Table 2-1: Forecast Evening Peak (17:00 – 18:00) Junction Impacts (ES)

Junction		Total EA THREE		
		Cars/LGVs	HGVs	Total
5	A12/A1214	88	22	110
6	A12/Newbourne Road	48	22	70
8	B1079/Manor Road	15	0	15
11	A12/B1438	134	22	156

3.0 Confirmed Playford Corner Works and Clappits Works Traffic Data

3.1 Introduction

In the context of the strategy set out in **Section 2.2**, and using the assessment assumptions, as summarised in **Section 2.1** (with the exception of car occupancy, as set out in **Section 3.2** below), the following text sets out the confirmed vehicle movements for the Playford Corner Works and Clappits Works and relevant cable installation works anticipated by NKT. The assessment is based on worst case during the construction programme, which is during the delivery of material for the construction of haul roads.

3.2 Trip Generation

The revised maximum (daily and evening peak) number of employee, employee vehicle movements and HGV movements associated with the construction of the Playford Corner Works and Clappits Works and the relevant cable installation works (i.e. Sections 1 to 7 of the cable route – see Figure 1 of the Outline Access Management Plan) are set out in **Table 3-1**.

This is based on a car occupancy of 1.5, which has been identified from lessons learnt from the EA TWO / EA ONE North ES and Examination, advice from SCC and through discussions with NKT, who have suggested that a 2.5 car occupancy is unlikely to be achievable.

Table 3-1: EA THREE Confirmed Maximum Figures (NKT)

	Employees				HGV Movements	
	Number		Vehicle Movements		Daily	PM Peak
	Daily	PM Peak	Daily	PM Peak		
Playford Corner and Clappits	60	60	80	40	40	4

3.3 Trip Distribution

The distribution for employee traffic and HGVs, as identified in the ES, is shown in **Table 3-2**.

Table 3-2: Traffic Distribution (ES)

Labour Type	Origin / Destination (%)					
	A12 South	A14 South	A12 North	A1214	A14 North	B1438
In-Migrant Labour (66%)	8.5	10.6	47.9	25.5	0	7.4
Resident Labour (34%)	43.6	2.0	8.9	21.8	19.8	4.0
HGVs	60	10	0	0	30	0

3.4 Assessment Scenarios

Based on the trip distribution in Table 3-2 and using the current construction programme, three scenarios have been defined (as shown in **Appendix 01**) to consider the maximum vehicle numbers (Scenario 1) and whilst very unlikely, two sensitivity tests of potential work area overlaps (Scenarios 2 and 3):

- **Scenario 1** - The NKT teams working on temporary haul roads for Jointing Bays 10 - 14 (Playford Corner) and Jointing Bays 20 - 22 (Clappits);
- **Scenario 2**: NKT teams working on Jointing Bays 10 - 14 (Playford Corner) and Jointing Bays 15 - 19 (Top Street) in the event of an overlap; and
- **Scenario 3**: NKT teams working on Jointing Bays 15 - 19 (Top Street) and Jointing Bays 20 - 22 in the event of an overlap

For Scenario 1, the maximum number of vehicle movements associated with the Playford Corner Works and Clappits Works and the relevant cable installation works (Sections 1 to 7) (NKT data) in the evening peak hour at Junctions 5, 6, 8 and 11 compared to the forecast EA THREE traffic movements at these junctions in the ES, is shown in **Table 3-3** to **Table 3-6**.

Table 3-3: Forecast 17:00 to 18:00 Junction Impacts (Junction 5: A12/A1214)

Arm	ES			NKT		
	Cars/LGVs	HGVs	Total	Cars/LGVs	HGVs	Total
A12 North	65	0	65	11	2	13
Main Road	0	0	0	0	0	0
A12 South	10	22	32	13	2	15
A1214	13	0	13	0	0	0
P&R	0	0	0	0	0	0
Total	88	22	110	24	4	28

Table 3-4: Forecast 17:00 to 18:00 Junction Impacts (Junction 6: A12/Newbourne Road)

Arm	ES			NKT		
	Cars/LGVs	HGVs	Total	Cars/LGVs	HGVs	Total
A12 North	38	0	38	6	2	8
Newbourne Road	5	0	5	19	0	19
A12 South	5	22	27	0	2	2
Foxhall Road	0	0	0	0	0	0
Total	48	22	70	25	4	29

Table 3-5: Forecast 17:00 to 18:00 Junction Impacts (Junction 8: B1079/Manor Road)

Arm	ES			NKT		
	Cars/LGVs	HGVs	Total	Cars/LGVs	HGVs	Total
B1079 West	4	0	4	19	0	19
B1079 East	9	0	9	0	0	0
Manor Road	2	0	2	0	0	0
Total	15	0	15	19	0	19

Table 3-6: Forecast 17:00 to 18:00 Junction Impacts (Junction 11: A12/B1438)

Arm	ES			NKT		
	Cars/LGVs	HGVs	Total	Cars/LGVs	HGVs	Total
A12 North	9	0	9	12	0	12
B1438	115	0	115	0	2	2
A12 South	10	22	32	8	2	10
Total	134	22	156	20	4	24

As **Table 3-3** to **Table 3-6** show, the confirmed vehicle numbers provided by NKT are less than those identified in the ES for the DCO submission. The large differences are due to the following:

- The ES assessed the peak traffic demand for each section, which was added together to create a theoretical 'in-combination' worst case and over-estimated;
- The NKT programme is such that the peak periods for the peak traffic demands do not overlap; and
- NKT has approximately half the jointing bays to construct, compared to the number assessed in the ES

Also, the number of vehicle movements is less than 30 (which is often used as a threshold for the need to undertake a capacity assessment) at any of the sensitive junctions, including for the sensitivity tests set out in Scenario 2 and 3, as shown in **Appendix 03**. The threshold is derived from DfT's Guidance on Transport Assessment (2007), which was withdrawn in 2014, however it is often still adopted by local highway authorities as a starting point for the consideration of likely impacts.

Notwithstanding the above, SLR has undertaken junction capacity assessments at the following junctions since the number of vehicle movements is close to 30:

- Junction 5: Roundabout junction of the A12 and A1214; and
- Junction 6: Roundabout junction of the A12 and Newbourne Road

The assessment of the likely impacts is set out in **Section 4.0**

4.0 Assessment of Likely Impacts

4.1 Introduction

This section presents a capacity assessment of the following sensitive junctions to assess the potential impact of the EA THREE construction traffic, based on the confirmed vehicle movement data provided by NKT.

- Junction 5: Roundabout junction of the A12 and A1214; and
- Junction 6: Roundabout junction of the A12 and Newbourne Road

4.2 Assessment Parameters

The assessment has been based on the following parameters:

- Evening Peak (17:00 to 18:00);
- 2024 assessment year;
- Addition of committed development traffic that is assumed likely to be on the highway network in 2024 from land at Adastral Park (3,000 dwellings) Planning Application Ref: DC/17/1435/OUT and Blacktiles Lane (47 dwellings) Planning Application Ref: DC/16/1992/FUL;
- Existing junction layouts; and
- Confirmed vehicle movement data provided by NKT as set out in **Table 3-3, Table 3-4** and **Table 3-6**.

Baseline traffic survey data has been obtained from the following

- Junction 5: A12/A14 – 2017 surveyed flows provided in the Transport Assessment (TA) prepared by TPA in December 2019) for the residential development at the Suffolk Constabulary Headquarters, in Martlesham Heath (Planning Application Ref: DC/20/0902/OUT; and
- Junction 6: A12/Newbourne Road – 2016 surveyed flows provided in the TA prepared in March 2019 by WYG for the Orwell Green Garden Village, development in Bucklesham (Planning Application Ref: DC/19/1988/OUT)

The data is provided in **Appendix 02**. The original survey data was not available for the 2016 data at the A12/Newbourne Road junction and therefore approximated HGV percentages have been applied to the Passenger Car Unit (PCU) flows using surveyed flows at the A12/A1214 and A12/Anson Road junctions as reasonable estimates.

Background traffic growth has been applied to the baseline traffic data to an assessment year of 2024, using TEMPRO v7.2, constrained to employment growth only given the addition of the committed housing schemes. Details of the committed development traffic data is provided in **Appendix 03**.

There is a highway improvement scheme proposed by SCC at the A12/A1214 junction; however, as this is not a committed scheme, the existing junction has been modelled.

There is a committed highway scheme at the A12/Newbourne Road roundabout associated with the Adastral Park development; however, this is not required until the occupation of the 601st dwelling and it is unlikely that this would occur by 2024, given the proposed build out rates set out in Table 23.1 of the Planning Statement submitted for the land at Astral Park application (prepared by CODE Development Planners Ltd. in March 2017) and as we understand no dwellings have currently been built and occupied.

4.3 Traffic Flows

The resulting traffic flows for the following assessment scenarios are provided in **Appendix 04**:

- 2024 base + committed development; and
- 2024 base + committed development + EA THREE

4.4 Capacity Assessments

4.4.1 Junction 5: Roundabout junction of the A12 and A1214

The ARCADY model of the existing junction layout presented in the TA for DC/20/0902/OUT (300 dwellings at the Suffolk Constabulary Headquarters at Martlesham Heath) has been replicated. The full Linsig results are provided **Appendix 05**.

Table 4-1 shows the 2017 evening peak scenario provided in the TA for DC/20/0902/OUT (Table 3.7) prepared by TPA compared to the results for the same scenario based on the replicated model.

The assessment with no Park and Ride stage has been selected, as during the peak periods, the Park and Ride stage of the sequence is rarely called, as stated in paragraph 3.110 in the TPA TA.

Table 4-1
Linsig Results (Junction 5: A12/A1214 - 17:00 to 18:00 – 2017 with No Park & Ride Stage)

Arm	TPA TA		SLR	
	Degree of Saturation	Mean Maximum Queue	Degree of Saturation	Mean Maximum Queue
A12 North	68.5	9	67.7	9
Main Road	19.7	1	19.2	1
A12 South	62.2	9	60.8	9
A1214	39.7	5	42.1	5
P&R	0	0	0	0
PRC	31.1%		32.9%	
DoS across all arms	68.5%		67.7%	

Table 4-1 shows the results of the Linsig model replicated by SLR are very similar to the results of the Linsig model in the TPA TA and is therefore considered to be a suitable model to assess the impacts of the EA THREE traffic flows in 2024.

The results of the 2024 assessment scenarios with and without the EA THREE traffic flows provided by NKT shown in **Table 4-2**.

Table 4-2
Linsig Results (Junction 5: A12/A1214 - 17:00 to 18:00)

Arm	2024 Base + Committed Development		2024 Base + Committed Development + EA THREE	
	Degree of Saturation (DoS)	Mean Maximum Queue (MMQ)	Degree of Saturation (DoS)	Mean Maximum Queue (MMQ)
A12 North	71.8	10	72.6	10
Main Road	21.9	1	22.1	1
A12 South	64.9	9	65.7	9
A1214	44.6	5	44.6	5
P&R	0	0	0	0
Practical Reserve Capacity (PRC)	25.4		24.0	
DoS across all arms	71.8%		72.6%	

Table 4-2 shows the junction is still predicted to operate within its design and theoretical capacity in 2024 with the addition of committed development traffic flows. The addition of the EA THREE traffic flows has no impact on Mean Maximum Queue (MMQ) lengths on any arm, with very minor changes to the Practical Reserve Capacity (PRC) and Degree of Saturation (DoS).

4.4.2 Junction 6: Roundabout junction of the A12/Newbourne Road

An ARCADY model has been built of the existing roundabout junction at the A12/Newbourne Road and the results of the two 2024 assessment scenarios identified above are provided in **Appendix 06** and summarised in **Table 4-3** below.

Table 4-3
ARCADY Results (Junction 6: A12/Newbourne Road - 17:00 to 18:00)

Arm	2024 Base + Committed Development		2024 Base + Committed Development + EA THREE	
	Ratio of Flow to Capacity (RFC)	Maximum Queue	Ratio of Flow to Capacity (RFC)	Maximum Queue
A12 North	1.21	216	1.21	224
Newbourne Road	0.94	8	0.99	13
A12 South	1.22	247	1.23	253
Foxhall Road	0.88	6	0.89	7

Table 4-3 shows the junction to be operating well over its theoretical capacity in the 2024 with committed development scenario, with significant queues on the A12 arms. The addition of the EA THREE traffic flows has

a negligible impact on the RFCs and maximum queues, with the biggest increase in RFC of 0.06 on Newbourne Road and the biggest increase in maximum queue of 8 vehicles on the A12 north. It should be highlighted that the majority of the EA THREE vehicles (20 cars/Light Goods Vehicles) at this junction will be leaving Newbourne Road during the evening peak hour, which is not shown to be over its theoretical capacity with the addition of the EA THREE traffic flows, with a minor increase in queue of 5 vehicles.

It should be highlighted that, whilst the junction is over capacity in the 2024 baseline with committed development traffic, once the RFC reached a value of 1, queues build exponentially in ARCADY, which wouldn't reflect what would occur in reality and the results should be treated with caution.

Given the very low and temporary number of EA THREE vehicle movements (32) forecast to use the junction in the evening peak hour and the uncertainty of committed development vehicle movements occurring by 2024, when NKT will be undertaking the commencement and relevant cable installation works, SLR would suggest the impacts at this junction can be considered negligible.

4.4.3 Capacity Assessment Summary

In summary, the forecast impact of the EA THREE vehicle movements associated with the Playford Corner Works and Clappits Works (and relevant cable installation works), in the evening peak hour (17:00 to 18:00) assessed against a 2024 with committed development baseline at Junction 5: A12/A1214 and Junction 6: A12/Newbourne Road, is negligible.

Following discussions with SCC, it has been agreed that that the constriction vehicle movements associated with the Playford Corner Works and Clappits Works (and relevant cable installation works), would not result in a material impact at the sensitive junctions.

SCC has advised, however, that should the Playford Corner Works and Clappits Works (and relevant cable installation works) be delayed by five or more years, the junction capacity assessments may be required to be revisited to take account of further background traffic growth.

5.0 Road Safety Assessment Review

5.1 Scope

The Crashmap database¹ has been used to compare the number of accidents and any clusters, for the five year period prior to the DCO application (2011 to 2015) and the most recent five year period available excluding 2020 as traffic levels will have been unrepresentative of typical conditions due to the Covid-19 pandemic (2015 to 2019), at the following locations on the A12:

- A12/B1079;
- A12/B1438;
- A12/A1214;
- A12/Newbourne Road;
- Routes from the A12:
 - B1079 between the A12 and Grundisburgh;
 - Woodbridge Road/Rose Hill/Ipswich Road between Grundisburgh and Bealings Road
 - Bealings Road; and
 - Newbourne Road/Ipswich Road

An analysis has been provided below with all associated Crashmap reports included in **Appendix 07**.

5.2 Analysis

5.2.1 A12/B1079

The number of accidents at the junction within the most recent five year period has shown a reduction from the number of accidents in the five year period prior to the submission of the DCO application:

- 2011 to 2015 - 10 accidents; and
- 2015 to 2019 – 7 accidents

There have been three accidents on the A12 southbound arm on approach to the junction in each of the five year periods recorded in 2015. A review of the available data shows the three accidents, which were in the vicinity of the give way line, were due to two separate causation factors; one involved conflict between a car and a pedal cycle, which appear to have collided side on; and two involving two vehicles, which both appear to have been a shunt. A further accident involved a pedal cycle in 2016 which occurred while vehicles were traversing the roundabout.

Overall, it can be concluded that there is not a deficiency in the highway layout that an increase in vehicles associated with the construction of EA THREE would exacerbate, and that human error and a lapse in concentration is likely the causation of the shunt accidents.

A further two accidents occurred on the A12 northbound arm on approach to the junction during both five year datasets which are of separate accounts. These have been reviewed and are, again, in vicinity of the give way line. One appears to be a shunt between a motorcycle and a car (motorcycle behind) and was serious in nature; while the other was between five cars and is of unknown causation. One casualty resulted with slight injury.

¹ www.crashmap.co.uk

5.2.2 A12/B1438

There has been a reduction in the number of accidents in the vicinity of the A12/ B1438 roundabout junction, with six occurring in the most recent five year period:

- 2011 to 2015 – 8; and
- 2015 to 2019 – 6

There are four accidents shown in relative proximity along the A12 southbound arm on approach to the junction set back from the give way line. A closer review of the detailed data, and their locations using OS data, has shown they took place apart from one another and so are not considered to be a cluster.

The remaining accidents are shown to be spread fairly evenly around the junction; therefore, it can be concluded that there are no road safety issues at this junction that an increase in vehicles associated with the construction of EA THREE would exacerbate.

5.2.3 A12/ A1214

There have been fewer accidents during the five year period of 2015-2019 than during the five year period prior to the submission of the DCO application.

- 2011 to 2015 – 8; and
- 2015 to 2019 – 6

There are no shown clusters of accidents as they are all fairly evenly spread around the junction; therefore, it can be concluded that there are no road safety issues at this junction that an increase in vehicles associated with the construction of EA THREE would exacerbate.

Two serious accidents did occur, with one shown in both dataset periods in 2015 which involved a single motorcycle. Despite a review of the detailed data report, it is unknown what occurred as it is stated the vehicle had no impact. The second accident serious in nature occurred in 2016 along Main Road and involved two cars. These two accidents are considered to be isolated events with no other accident occurring nearby.

5.2.4 A12/Newbourne Road

The number of accidents at the junction within the most recent five year period is slightly less than the number of accidents in the five year period prior to the submission of the DCO application:

- 2011 to 2015 – 11; and
- 2015 to 2019 – 10

Two clusters have been identified at this junction; the first being at the give way line along the Foxhall Road eastbound arm containing three accidents, and the second occurring at the give way line along the A12 northbound arm containing two accidents. A review of the detailed accident data has shown that all of these accidents are of the same type and are a shunt accident from behind involving cars with one on the A12 arm involving a motorcycle. None of these accidents were serious or fatal.

Two of the three accidents along the Foxhall Road arm occurred in 2015, meaning just one of the accidents is an additional from the five year period prior to the submission of the DCO application; while one of the two accidents along the A12 arm occurred in 2015. This suggests that, as one additional accident has occurred in both locations since 2015, there is unlikely to be any deficiencies in the highway layout that an increase in vehicles associated with the construction of EA THREE would exacerbate.

5.2.5 Routes from the A12

Table

5-1

Road Safety Review on the EA THREE Construction Routes from the A12 shows the number of recorded accidents on the EA THREE construction access routes from the A12 that would be used by vehicles associated with the construction of the EA THREE Playford Corner Works and Clappits Works and the relevant cable installation works (Sections 7 to 10) in each five year period.

Table 5-1
Road Safety Review on the EA THREE Construction Routes from the A12

Route	Period (Number of Accidents)	
	2011 - 2015	2015 - 2019
B1079 between the A12 and Grundisburgh	8	5
Woodbridge Road/Ipswich Road between Grundisburgh and Bealings Road	4	2
Bealings Road	4	4
Newbourne Road/Ipswich Road	2	2

As shown in **Table 5-1** the number of accidents has either remained the same or reduced on each of the routes between the five year period prior to the DCO submission and the most recent five year period. Also, all accidents were slight in severity and occurred at different locations. Therefore, it can be concluded that there are no road safety issues on these routes that an increase in vehicles associated with the construction of EA THREE would exacerbate.

5.3 Summary

The review of road safety in this section would indicate that there has been a general improvement of road safety since the submission of the DCO application, with no deficiency in the layout or condition of the junctions and routes reviewed.

Therefore, no changes to the measures proposed in the Traffic Management Plan are considered to be necessary, which has been agreed by SCC.

6.0 Summary and Conclusion

6.1 Summary

This Technical Note sets out the anticipated maximum number of vehicle movements associated with the construction of the EA THREE Playford Corner Works and Clappits Works and the relevant cable installation works (Sections 7 to 10) in the evening peak hour at sensitive junctions on the A12 junction using confirmed data from NKT. The assessment is based on a lower (and more realistic) vehicle occupancy of 1.5 employees, compared to the vehicle occupancy of 2.5 used in the ES for the DCO application.

Junction capacity assessments has been undertaken to test the impact of the confirmed EA THREE traffic data at the junctions, using the most recent baseline traffic data available and incorporating vehicle movements associated with various committed developments. The assessment confirmed there would be no or negligible additional queuing at the sensitive junctions with the addition of the EA THREE vehicle movements compared to the 2024 with committed development scenario.

A review of road safety on the routes that would be used by the construction traffic associated with the construction of the EA THREE Playford Corner Works and Clappits Works and the relevant cable installation works (Sections 7 to 10) shows there are no road safety issues that would be exacerbated by an increase in traffic flows and that no changes to the measures proposed in the EA THREE Traffic Management Plan are required.

6.2 Conclusion

As demonstrated, the impact of the confirmed EA THREE Playford Corner Works and Clappits Works and the relevant cable installation works (Sections 7 to 10) traffic data is such that there would be no significant impacts on capacity and no impacts on road safety on the routes used by construction traffic, with no mitigation required.

In, conclusion, as agreed with SCC, no further assessments on the highway network are required prior to the commencement of construction associated with the EA THREE Playford Corner Works and Clappits Works and the relevant cable installation works (Sections 7 to 10).

APPENDIX 01

NKT Vehicle Movements (including Sensitivity Tests)

Origin/Destination	66%		34%	
	In-Migrant Labour	Resident Labour	Total	Proportion
A12 South	8.5%	5.6%	43.6%	14.8%
B1113	0.0%	0.0%	0.0%	0.0%
A14 South	10.6%	7.0%	2.0%	0.7%
A12 north	47.9%	31.6%	8.9%	3.0%
B1078	0.0%	0.0%	0.0%	0.0%
A1214	25.5%	16.8%	21.8%	7.4%
A14 North	0.0%	0.0%	19.8%	6.7%
B1438	7.4%	4.9%	4.0%	1.4%
Total	99.90%	65.93%	100.10%	34.03%

Programme Snapshot for Haul Road Construction and TJBs

	Start	Finish
Install Temporary Haul Roads	Mar-24	Jul-24
Transition Jointing Bays	Jul-24	Oct-24
TJB 10-14	Jul-24	Aug-24
TJB 15-19	Aug-24	Aug-24
TJB 20-22	Sep-24	Sep-24

NKT Daily Data Summary (peak during haul road construction)

Location	HGVs		Employees	
	Average	Peak	Average	Peak
Location 1	32	40	20	30
Location 2	32	40	20	30
Total	64	80	40	60

NKT Daily Data Summary (TJBs)

TJB	HGVs		Employees	
	Average	Peak	Average	Peak
TJB 10-14	8	12	12	25
TJB 15-19	8	12	12	25
TJB 20-22	8	12	12	25

Scenario 1: NKT teams working on temporary haul roads for Jointing Bays 10 - 14 (Playford Corner) and Jointing Bays 20 - 22 (Clappits)

Employee vehicles leaving work locations served from the B1079 (Jointing Bays 10-14)
Assumed A14 N vehicles wouldn't join the A12

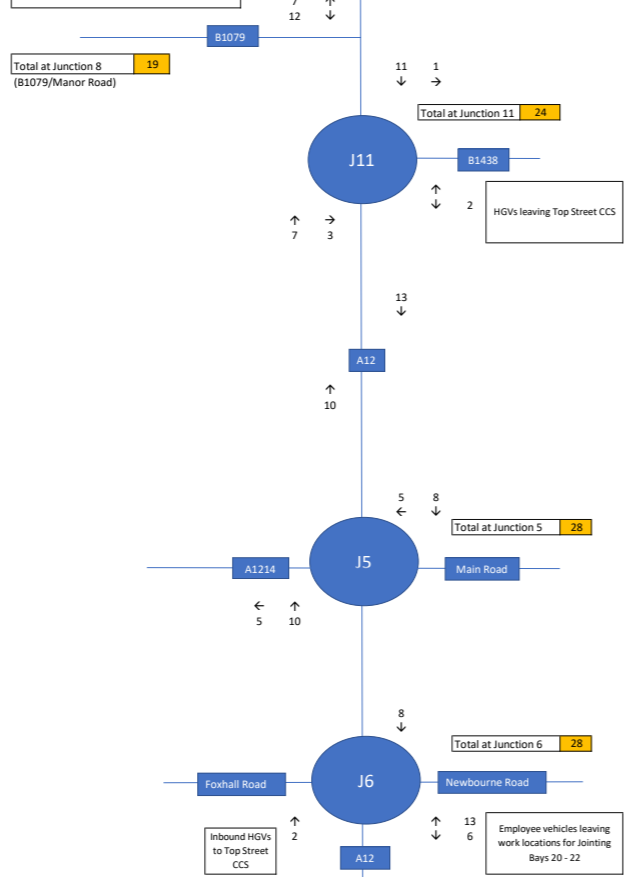

Scenario 2: NKT teams working on Jointing Bays 10 - 14 (Playford Corner) and Jointing Bays 15 - 19 (Top Street) in the event of an overlap

Employee vehicles leaving work locations served from the B1079 (Jointing Bays 10-14)
Assumed A14 N vehicles wouldn't join the A12

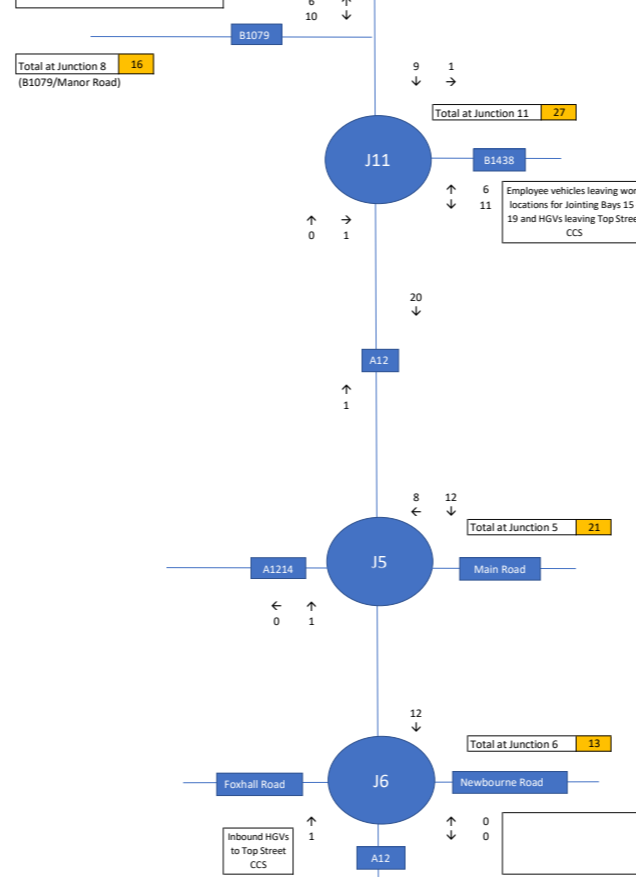

Scenario 3: NKT teams working on Jointing Bays 15 - 19 (Top Street) and Jointing Bays 20 - 22 in the event of an overlap

Employee vehicles leaving work locations served from the B1079 (Jointing Bays 10-14)
Assumed A14 N vehicles wouldn't join the A12

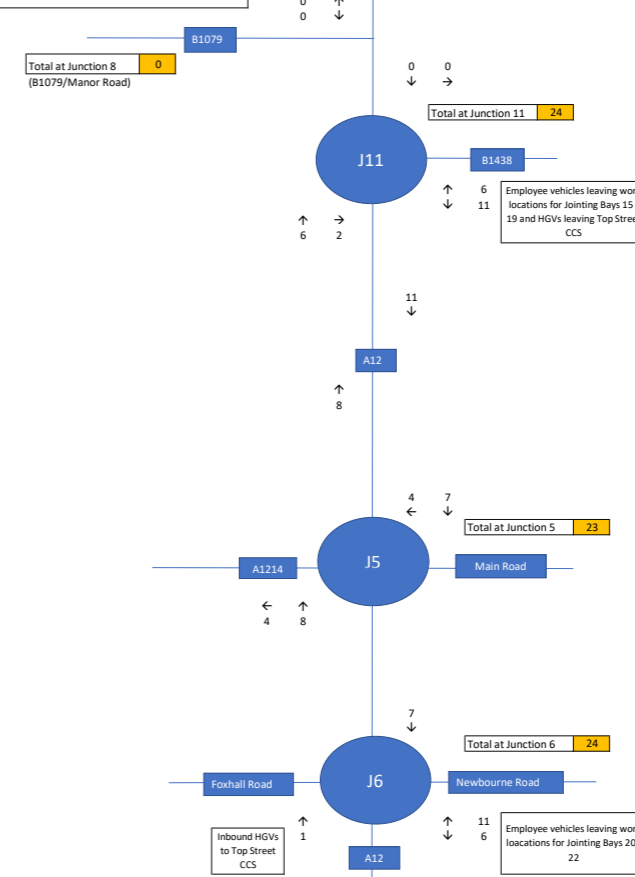

APPENDIX 02

Baseline Traffic Flows

RESERVED COPYRIGHT

A3 ORIGINAL PLOT SIZE



INDICATIVE

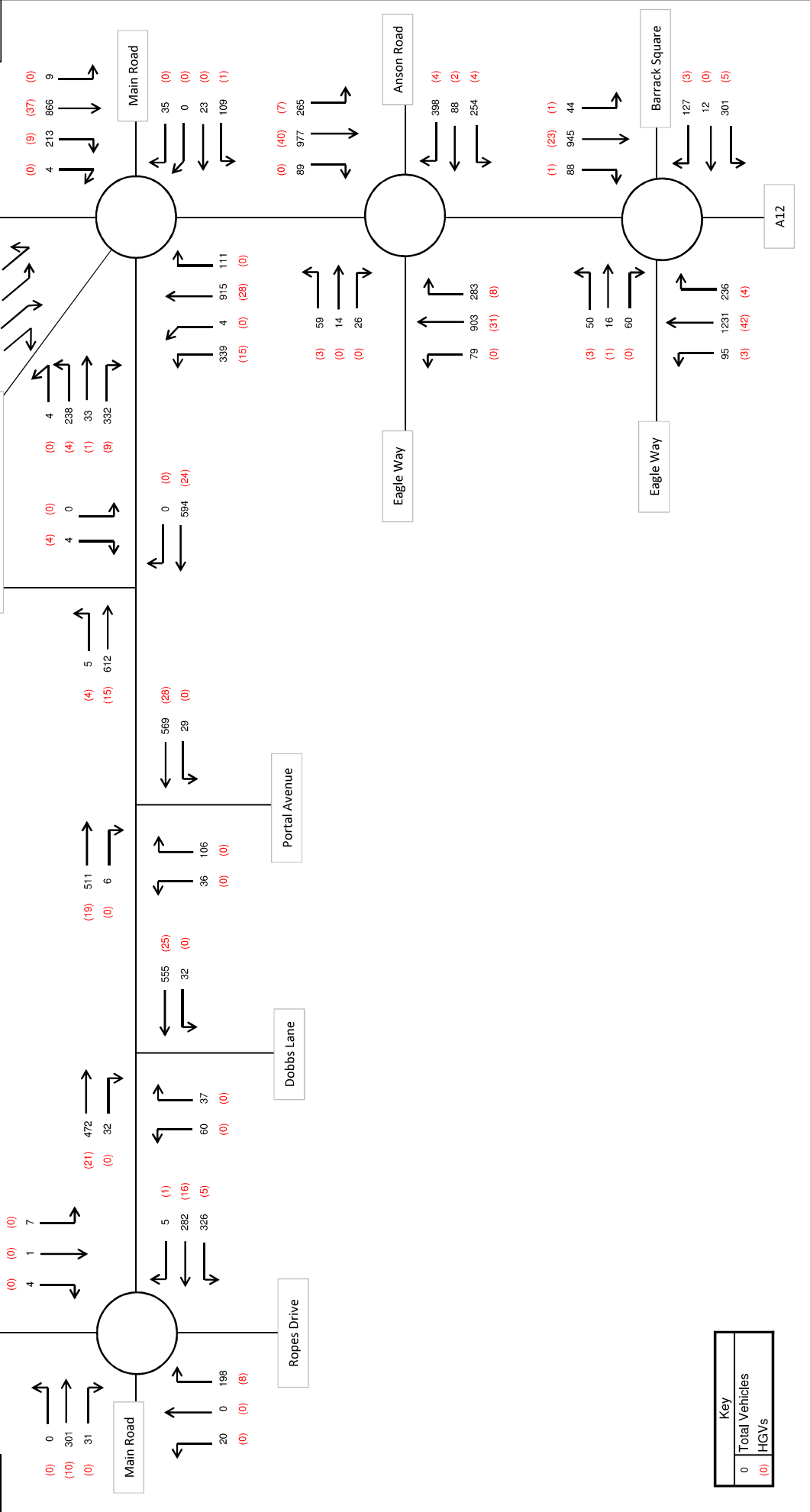

Key	
0	Total Vehicles
(0)	HGVs

<p>Drawn: Cambridge, London, Oxford, Woking, Ipswich, Whittlesey, Gosport, City</p> <p>The Studio: 7, Oxenford Mill, Fenny's Road, Cambridge CB1 3JF, UK Tel: 01223 455395 www.tpa.co.uk</p>	Date: NOV '19	Status: NTS
	<p>Scale: NTS</p>	
<p>Surveyed Traffic Flows - Evening peak (17:00-18:00)</p>		
<p>Suffolk Constabulary, Martlesham</p>		
<p>Prepared By: LM</p>	<p>Checked By: IB</p>	<p>Approved By: IB</p>
<p>Project No: 1605-81</p>	<p>Figure No: 3.7</p>	<p>Revision: -</p>

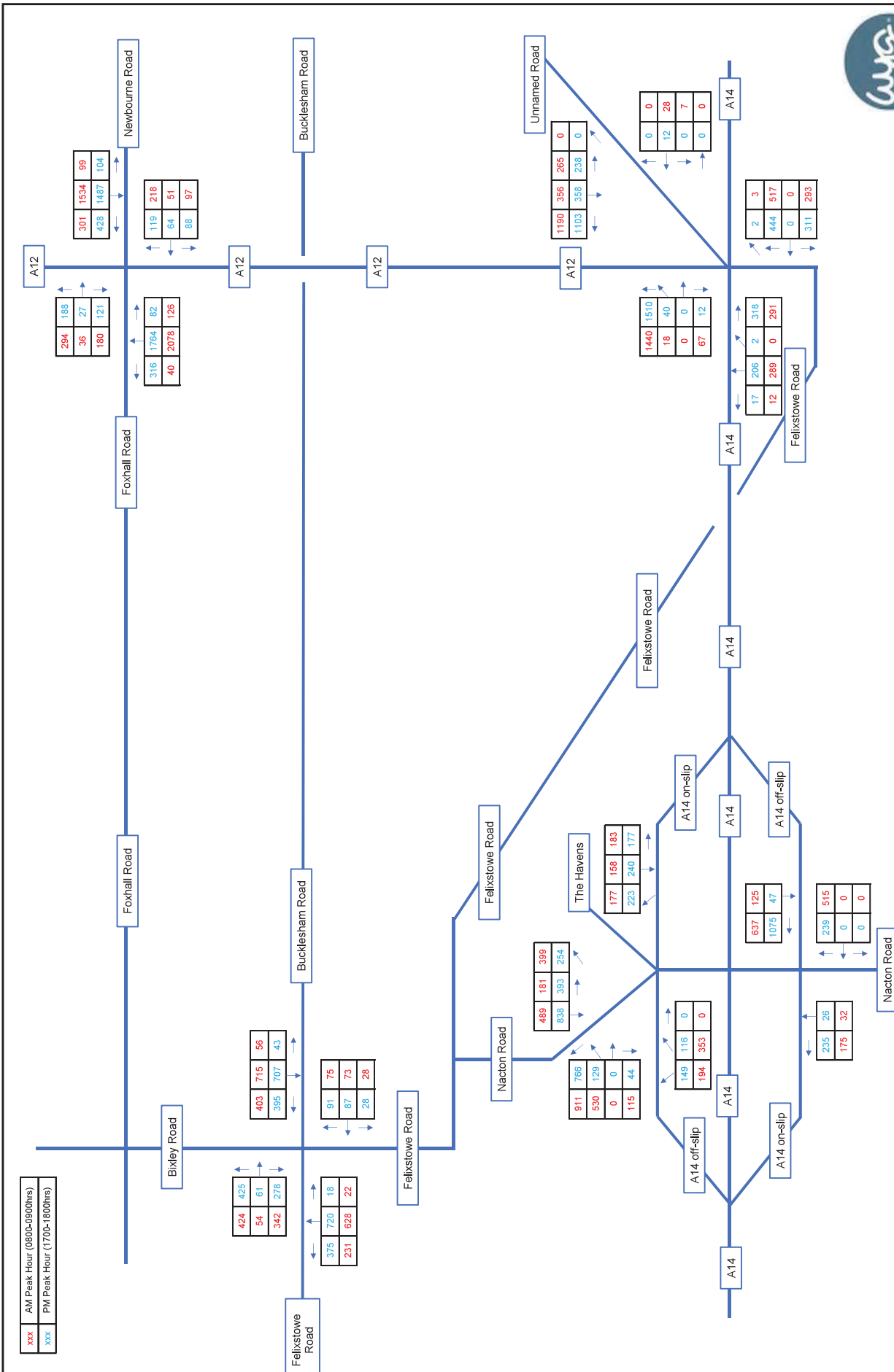

Figure 7.1 - 2016 Base Traffic Flows (PCUs)

APPENDIX 03

Committed Development Traffic Flows

Junction 5: A12/A1214

Adastral Park (DC/17/1435/OUT)

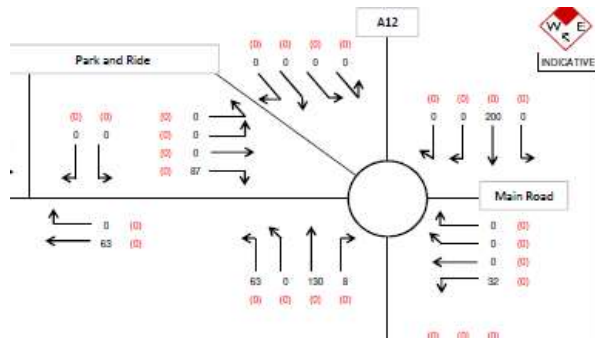

Blacktiles Lane (DC/16/1992/FUL)

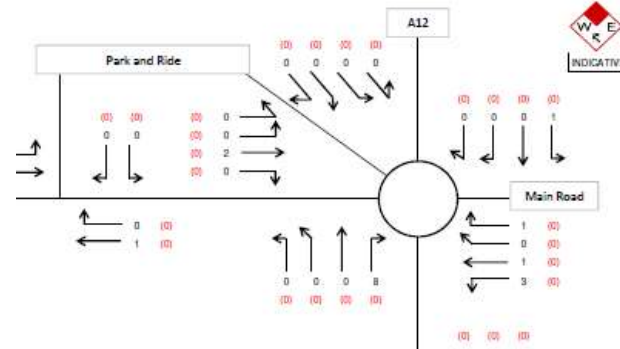

Junction 6: A12/Newbourne Road

Adastral Park (DC/17/1435/OUT)

Original Phasing Plan

Table 23.1

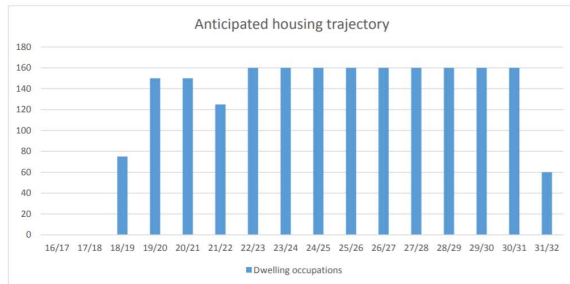

Assume first occupations in 2023

Assessment year of 2024

Assume 225 dwellings occupied

11%

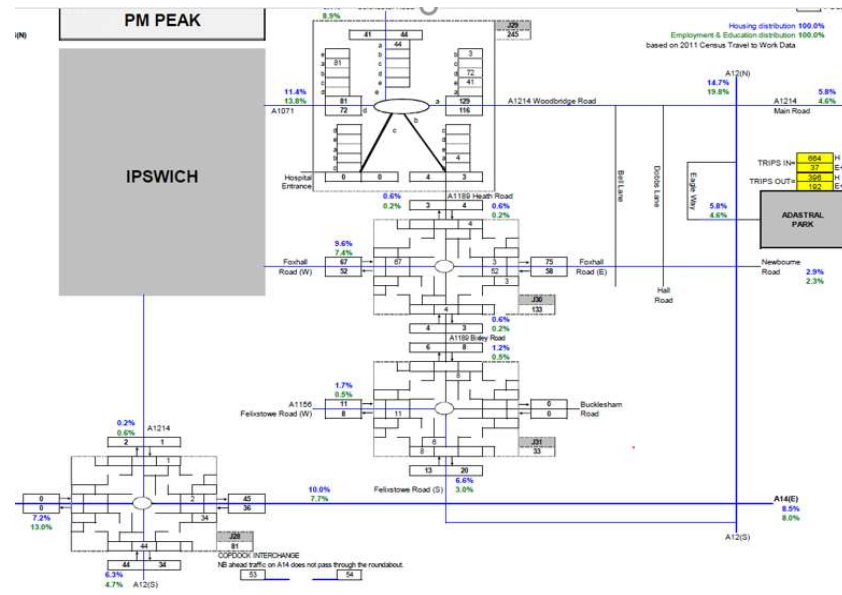

	Total		Dist.	A12 S		Foxhall Road		Newbourne Road		
	Arrivals	Departures		Arrivals	Departures	Arrivals	Departures	Dist.	Arrivals	Departures
Housing	664	396	38.80%	258	154			2.90%	19	11
Employment	37	192	37.00%	14	71			2.30%	1	4
Total	701	588		271	225	75	38		20	16
11% at 2024	77	65	0	30	25	8	4	0	2	2

APPENDIX 04

Assessment Scenario Traffic Flows

A12/A1214/Main Road

	From	Cars					HGVs					PCUs				
		To					To					To				
		A12 S	A1214	P&R	A12 N	Main Road	A12 S	A1214	P&R	A12 N	Main Road	A12 S	A1214	P&R	A12 N	Main Road
Base 2017	A12 S															
	A1214										341	354	4	943	111	
	P&R												4	242	34	
	A12 N										903	222	4		9	
	Main Road										110	23		35		
2024	A12 S											370	4	986	116	
<i>Employment Growth only</i>	A1214										356		4	253	36	
<i>1.0451</i>	P&R															
	A12 N										944	232	4		9	
	Main Road										115	24		37		
Committed development	A12 S		7		14	9						7		14	9	
<i>Adastral Park 11% built-out</i>	A1214	10				2					10				2	
<i>Blacktiles Lane</i>	P&R															
	A12 N	22				1					22				1	
	Main Road	7	1		1						7	1		1		
EA3	A12 S		5		9					2		5		14		
<i>Worst case commencement / cable works</i>	A1214															
	P&R															
	A12 N	8	5				2				13	5				
	Main Road															
Base 2024 + Com Dev	A12 S		7		14	9						377	4	1000	125	
	A1214	10				2					366		4	253	38	
	P&R															
	A12 N	22				1					966	232	4		10	
	Main Road	7	1		1						121	25		38		
Base 2024 + Com Dev EA3	A12 S		12		24	9				2		382	4	1014	125	
	A1214	10				2					366		4	253	38	
	P&R															
	A12 N	30	5		1		2				979	237	4		10	
	Main Road	7	1		1						121	25		38		

A12/Foxhall Road/Newbourne Road

	From	Cars				HGVs				PCUs			
		To				To				To			
		A12 N	Newbourne Road	A12 S	Foxhall Road	A12 N	Newbourne Road	A12 S	Foxhall Road	A12 N	Newbourne Road	A12 S	Foxhall Road
Base 2016	A12 N										104	1487	428
	Newbourne Road									119		88	64
	A12 S									1764	82		316
	Foxhall Road									188	27	121	
2024	A12 N										109	1555	448
<i>Employment Growth only</i>	Newbourne Road									124		92	67
<i>1.0457</i>	A12 S									1845	86		330
	Foxhall Road									197	28	127	
Committed Development	A12 N												
<i>Adastral Park 11% built-out</i>	Newbourne Road	2		25	4	2				7		25	4
	A12 S	30								30			
	Foxhall Road	8								8			
EA3	A12 N			8				2					13
<i>Wosrt case commencement /cable works</i>	Newbourne Road	14		6						14		6	
	A12 S					2				5			
	Foxhall Road												
Base 2024 + Com Dev	A12 N										109	1555	448
	Newbourne Road	2		25	4	2				132		117	71
	A12 S	30								1874	86		330
	Foxhall Road	8								205	28	127	
Base 2024 + Com Dev + EA3	A12 N			8				2			109	1568	448
	Newbourne Road	16		30	4	2				146		122	71
	A12 S	30				2				1879	86		330
	Foxhall Road	8								205	28	127	

APPENDIX 05

Linsig Model Results (A12/A1214)

Full Input Data And Results
Full Input Data And Results

User and Project Details

Project:	East Anglia Three
Title:	
Location:	A12/A1214/Main Road, Martlesham
Client:	Scottish Power Renewables
Additional detail:	
File name:	A12_A1214_Main Road 14.01.22
Author:	
Company:	
Address:	

Network Layout Diagram

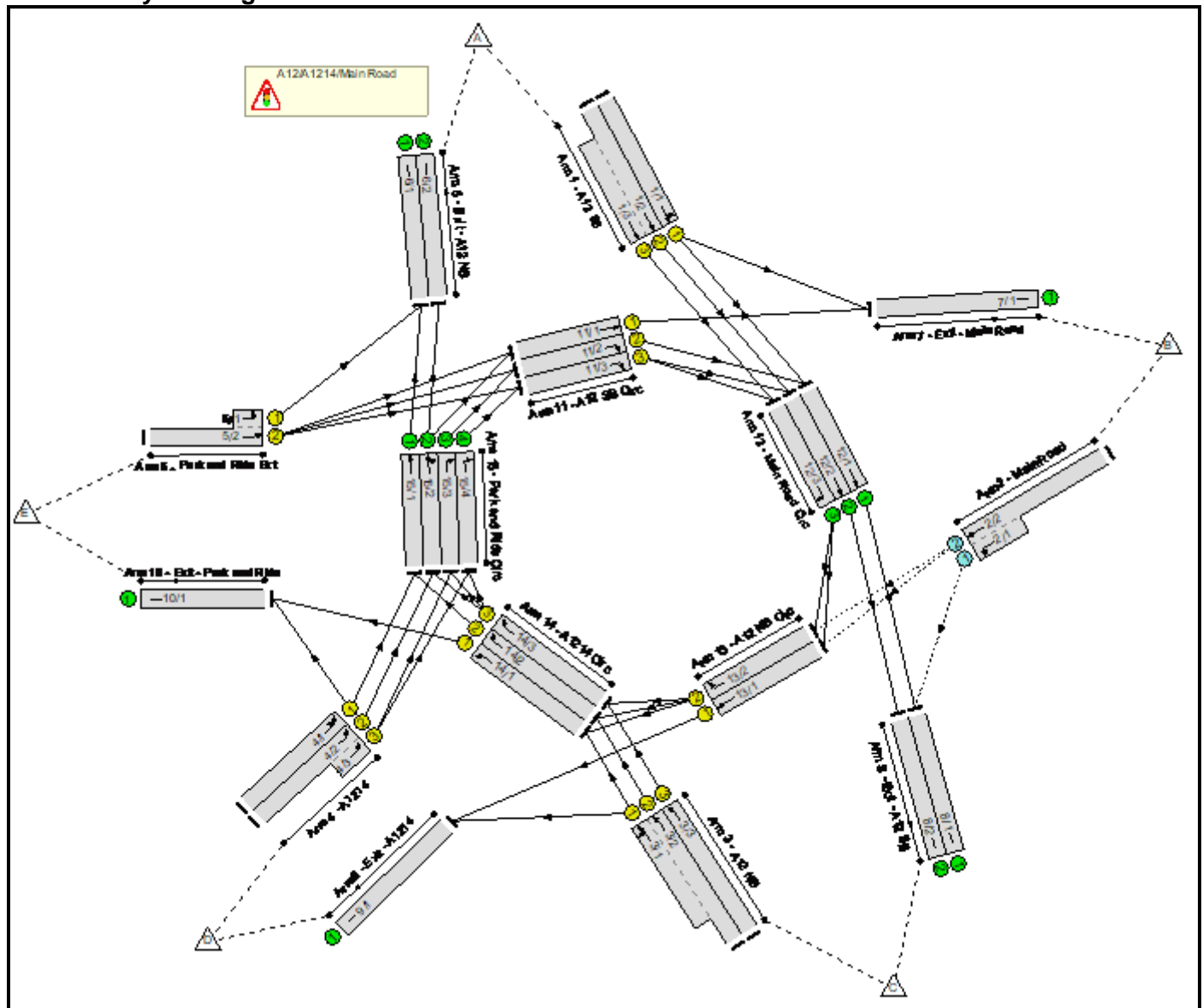

Phase Diagram

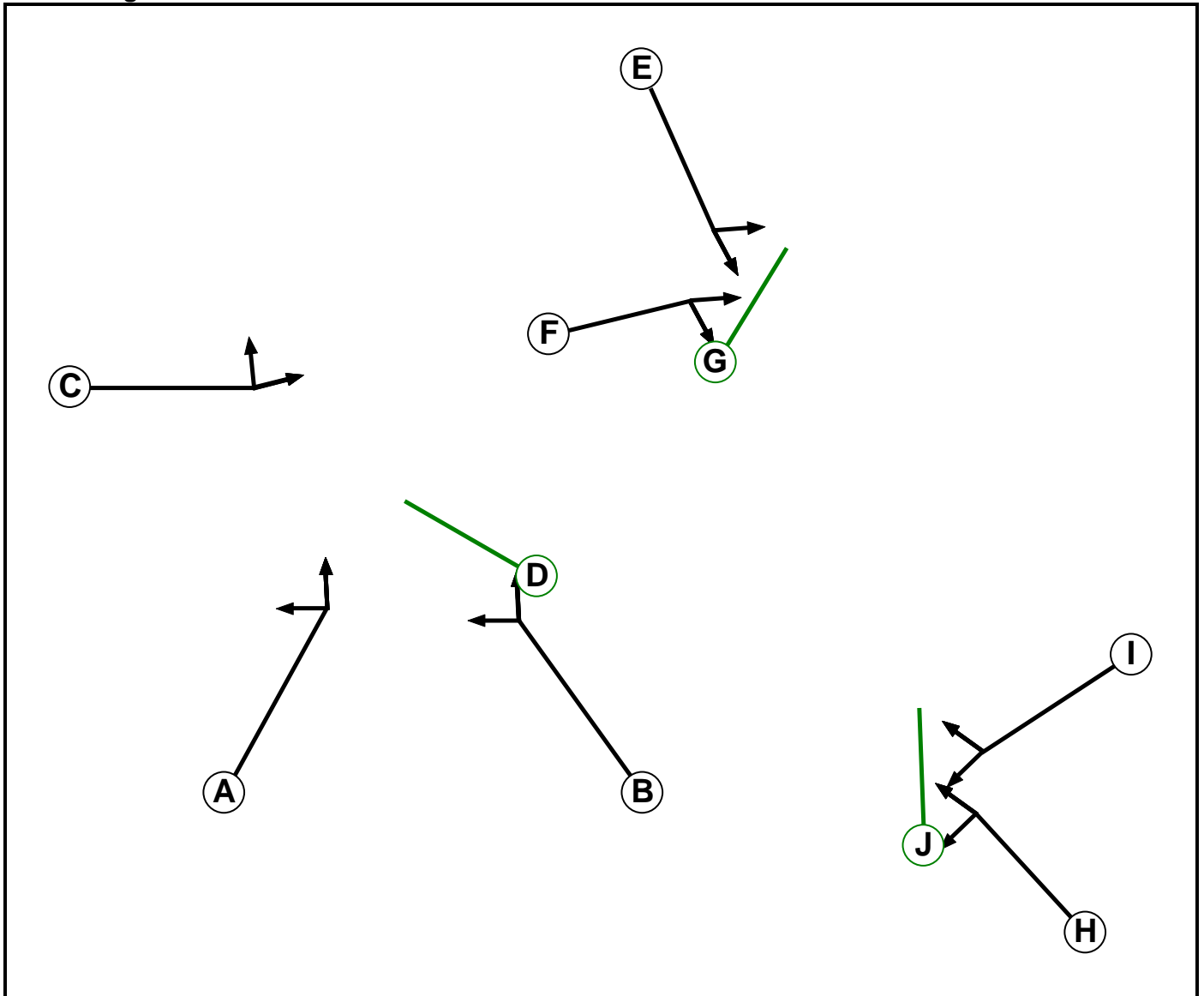

Phase Input Data

Phase Name	Phase Type	Stage Stream	Assoc. Phase	Street Min	Cont Min
A	Traffic	1		7	7
B	Traffic	1		7	7
C	Traffic	1		7	7
D	Dummy R/A	1		7	7
E	Traffic	2		7	7
F	Traffic	2		7	7
G	Dummy R/A	2		7	7
H	Traffic	3		7	7
I	Traffic	3		7	7
J	Dummy R/A	3		7	7

Full Input Data And Results

Phase Intergrens Matrix

	Starting Phase										
	A	B	C	D	E	F	G	H	I	J	
Terminating Phase	A		5	9	3	-	-	-	-	-	-
	B	5		9	3	-	-	-	-	-	-
	C	5	5		3	-	-	-	-	-	-
	D	2	2	2		-	-	-	-	-	-
	E	-	-	-	-		5	3	-	-	-
	F	-	-	-	-	5		3	-	-	-
	G	-	-	-	-	2	2		-	-	-
	H	-	-	-	-	-	-	-		5	3
	I	-	-	-	-	-	-	-	5		3
	J	-	-	-	-	-	-	-	2	2	

Phases in Stage

Stream	Stage No.	Phases in Stage
1	1	A
1	2	B
1	3	C
1	4	D
2	1	E
2	2	F
2	3	G
3	1	H
3	2	I
3	3	J

Stage Diagram

Stage Stream: 1

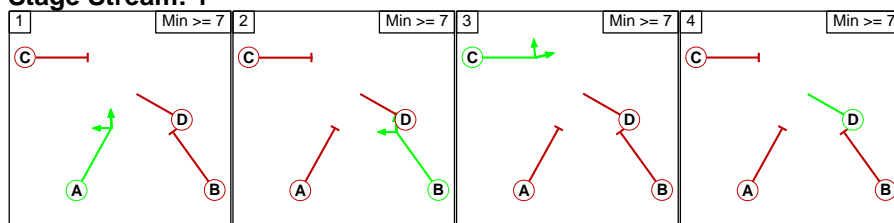

Stage Stream: 2

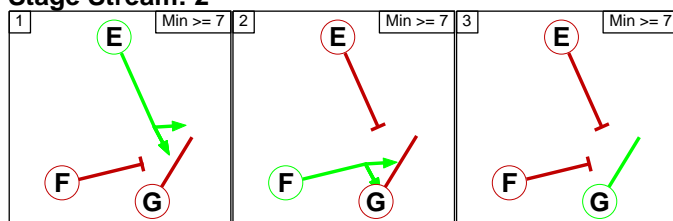

Full Input Data And Results

Stage Stream: 3

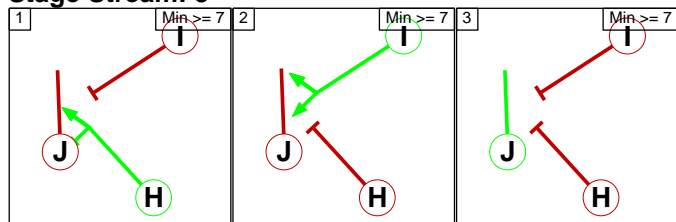

Phase Delays

Stage Stream: 1

Term. Stage	Start Stage	Phase	Type	Value	Cont value
There are no Phase Delays defined					

Stage Stream: 2

Term. Stage	Start Stage	Phase	Type	Value	Cont value
There are no Phase Delays defined					

Stage Stream: 3

Term. Stage	Start Stage	Phase	Type	Value	Cont value
There are no Phase Delays defined					

Prohibited Stage Change

Stage Stream: 1

		To Stage			
		1	2	3	4
From Stage	1		5	9	3
	2	5		9	3
	3	5	5		3
	4	2	2	2	

Stage Stream: 2

		To Stage		
		1	2	3
From Stage	1		5	3
	2	5		3
	3	2	2	

Stage Stream: 3

		To Stage		
		1	2	3
From Stage	1		5	3
	2	5		3
	3	2	2	

Full Input Data And Results

Give-Way Lane Input Data

Junction: A12/A1214/Main Road											
Lane	Movement	Max Flow when Giving Way (PCU/Hr)	Min Flow when Giving Way (PCU/Hr)	Opposing Lane	Opp. Lane Coeff.	Opp. Mvmnts.	Right Turn Storage (PCU)	Non-Blocking Storage (PCU)	RTF	Right Turn Move up (s)	Max Turns in Intergreen (PCU)
2/1 (Main Road)	8/1 (Left)	852	0	12/1	0.49	All	-	-	-	-	-
2/2 (Main Road)	13/1 (Ahead)	852	0	12/1	0.49	All	-	-	-	-	-
				12/2	0.49	All					
				12/3	0.49	All					
	13/2 (Ahead)	852	0	12/1	0.49	All					
				12/2	0.49	All					
				12/3	0.49	All					

Full Input Data And Results

Lane Input Data

Junction: A12/A1214/Main Road												
Lane	Lane Type	Phases	Start Disp.	End Disp.	Physical Length (PCU)	Sat Flow Type	Def User Saturation Flow (PCU/Hr)	Lane Width (m)	Gradient	Nearside Lane	Turns	Turning Radius (m)
1/1 (A12 SB)	U	E	2	3	60.0	Geom	-	3.40	0.00	Y	Arm 7 Left	Inf
											Arm 12 Ahead	Inf
1/2 (A12 SB)	U	E	2	3	60.0	Geom	-	3.50	0.00	N	Arm 12 Ahead	Inf
1/3 (A12 SB)	U	E	2	3	13.2	Geom	-	3.60	0.00	Y	Arm 12 Ahead	Inf
2/1 (Main Road)	O		2	3	4.7	Geom	-	4.00	0.00	Y	Arm 8 Left	Inf
2/2 (Main Road)	O		2	3	60.0	Geom	-	4.00	0.00	Y	Arm 13 Ahead	Inf
3/1 (A12 NB)	U	H	2	3	14.8	Geom	-	3.80	0.00	Y	Arm 9 Left	Inf
											Arm 14 Ahead	Inf
3/2 (A12 NB)	U	H	2	3	60.0	Geom	-	3.60	0.00	N	Arm 14 Ahead	Inf
3/3 (A12 NB)	U	H	2	3	60.0	Geom	-	3.70	0.00	Y	Arm 14 Ahead	Inf
4/1 (A1214)	U	A	2	3	60.0	Geom	-	4.10	0.00	Y	Arm 10 U-Turn	Inf
											Arm 15 Left	Inf
4/2 (A1214)	U	A	2	3	60.0	Geom	-	4.10	0.00	N	Arm 15 Left	Inf
4/3 (A1214)	U	A	2	3	3.2	Geom	-	4.20	0.00	Y	Arm 15 Left	Inf
5/1 (Park and Ride Exit)	U	C	2	3	2.4	Geom	-	4.10	0.00	Y	Arm 6 Left	Inf
5/2 (Park and Ride Exit)	U	C	2	3	60.0	Geom	-	4.00	0.00	Y	Arm 11 Ahead	Inf
6/1 (Exit - A12 NB)	U		2	3	60.0	Inf	-	-	-	-	-	-
6/2 (Exit - A12 NB)	U		2	3	60.0	Inf	-	-	-	-	-	-
7/1 (Exit - Main Road)	U		2	3	60.0	Inf	-	-	-	-	-	-
8/1 (Exit - A12 SB)	U		2	3	60.0	Inf	-	-	-	-	-	-
8/2 (Exit - A12 SB)	U		2	3	60.0	Inf	-	-	-	-	-	-

Full Input Data And Results

9/1 (Exit - A1214)	U		2	3	60.0	Inf	-	-	-	-	-	-
10/1 (Exit - Park and Ride)	U		2	3	60.0	Inf	-	-	-	-	-	-
11/1 (A12 SB Circ)	U	F	2	3	2.8	Geom	-	4.90	0.00	Y	Arm 7 Ahead	Inf
11/2 (A12 SB Circ)	U	F	2	3	2.8	Geom	-	4.90	0.00	N	Arm 12 Right	Inf
11/3 (A12 SB Circ)	U	F	2	3	2.8	Geom	-	4.70	0.00	Y	Arm 12 Right	Inf
12/1 (Main Road Circ)	U		2	3	2.6	Geom	-	4.40	0.00	Y	Arm 8 Ahead	Inf
12/2 (Main Road Circ)	U		2	3	2.6	Geom	-	4.40	0.00	Y	Arm 8 Ahead	Inf
12/3 (Main Road Circ)	U		2	3	2.6	Geom	-	3.80	0.00	Y	Arm 13 Right	Inf
13/1 (A12 NB Circ)	U	I	2	3	2.3	Geom	-	4.40	0.00	Y	Arm 9 Ahead	Inf
13/2 (A12 NB Circ)	U	I	2	3	2.3	Geom	-	4.40	0.00	Y	Arm 14 Right	Inf
14/1 (A1214 Circ)	U	B	2	3	2.6	Geom	-	4.60	0.00	Y	Arm 10 Ahead	Inf
14/2 (A1214 Circ)	U	B	2	3	2.4	Geom	-	4.40	0.00	N	Arm 15 Right	Inf
14/3 (A1214 Circ)	U	B	2	3	2.3	Geom	-	4.40	0.00	Y	Arm 15 Right	Inf
15/1 (Park and Ride Circ)	U		2	3	1.4	Geom	-	4.90	0.00	Y	Arm 6 Ahead	Inf
15/2 (Park and Ride Circ)	U		2	3	1.4	Geom	-	4.90	0.00	N	Arm 6 Ahead	Inf
15/3 (Park and Ride Circ)	U		2	3	1.4	Geom	-	4.90	0.00	N	Arm 11 Right	Inf
15/4 (Park and Ride Circ)	U		2	3	1.4	Geom	-	4.90	0.00	Y	Arm 11 Right	Inf

Traffic Flow Groups

Flow Group	Start Time	End Time	Duration	Formula
1: '2017 Survey (No Park and Ride) - PM Peak'	17:00	18:00	01:00	
2: '2024 Base + Com Dev - PM Peak'	17:00	18:00	01:00	
3: '2024 Base + Com Dev + EA3 - PM Peak'	17:00	18:00	01:00	

Full Input Data And Results

Scenario 1: '2017 Survey (No Park and Ride) - PM Peak' (FG1: '2017 Survey (No Park and Ride) - PM Peak', Plan 1: 'Network Control Plan 1')

Traffic Flows, Desired

Desired Flow :

		Destination					
		A	B	C	D	E	Tot.
Origin	A	0	9	903	222	4	1138
	B	35	0	110	23	0	168
	C	943	111	0	354	4	1412
	D	242	34	341	0	4	621
	E	0	0	0	0	0	0
	Tot.	1220	154	1354	599	12	3339

Full Input Data And Results

Traffic Lane Flows

Lane	Scenario 1: 2017 Survey (No Park and Ride) - PM Peak
Junction: A12/A1214/Main Road	
1/1	413
1/2 (with short)	725(In) 499(Out)
1/3 (short)	226
2/1 (short)	110
2/2 (with short)	168(In) 58(Out)
3/1 (short)	358
3/2 (with short)	900(In) 542(Out)
3/3	512
4/1	172
4/2 (with short)	449(In) 108(Out)
4/3 (short)	341
5/1 (short)	0
5/2 (with short)	0(In) 0(Out)
6/1	730
6/2	490
7/1	154
8/1	692
8/2	662
9/1	599
10/1	12
11/1	145
11/2	178
11/3	163
12/1	582
12/2	662
12/3	226
13/1	245
13/2	39
14/1	8
14/2	562
14/3	527
15/1	730
15/2	635

Full Input Data And Results

15/3	178
15/4	163

Full Input Data And Results

Lane Saturation Flows

Junction: A12/A1214/Main Road								
Lane	Lane Width (m)	Gradient	Nearside Lane	Allowed Turns	Turning Radius (m)	Turning Prop.	Sat Flow (PCU/Hr)	Flared Sat Flow (PCU/Hr)
1/1 (A12 SB)	3.40	0.00	Y	Arm 7 Left	Inf	2.2 %	1955	1955
				Arm 12 Ahead	Inf	97.8 %		
1/2 (A12 SB)	3.50	0.00	N	Arm 12 Ahead	Inf	100.0 %	2105	2105
1/3 (A12 SB)	3.60	0.00	Y	Arm 12 Ahead	Inf	100.0 %	1975	1975
2/1 (Main Road)	4.00	0.00	Y	Arm 8 Left	Inf	100.0 %	2015	2015
2/2 (Main Road)	4.00	0.00	Y	Arm 13 Ahead	Inf	100.0 %	2015	2015
3/1 (A12 NB)	3.80	0.00	Y	Arm 9 Left	Inf	98.9 %	1995	1995
				Arm 14 Ahead	Inf	1.1 %		
3/2 (A12 NB)	3.60	0.00	N	Arm 14 Ahead	Inf	100.0 %	2115	2115
3/3 (A12 NB)	3.70	0.00	Y	Arm 14 Ahead	Inf	100.0 %	1985	1985
4/1 (A1214)	4.10	0.00	Y	Arm 10 U-Turn	Inf	2.3 %	2025	2025
				Arm 15 Left	Inf	97.7 %		
4/2 (A1214)	4.10	0.00	N	Arm 15 Left	Inf	100.0 %	2165	2165
4/3 (A1214)	4.20	0.00	Y	Arm 15 Left	Inf	100.0 %	2035	2035
5/1 (Park and Ride Exit)	4.10	0.00	Y	Arm 6 Left	Inf	0.0 %	2025	2025
5/2 (Park and Ride Exit)	4.00	0.00	Y	Arm 11 Ahead	Inf	0.0 %	2015	2015
6/1 (Exit - A12 NB Lane 1)	Infinite Saturation Flow						Inf	Inf
6/2 (Exit - A12 NB Lane 2)	Infinite Saturation Flow						Inf	Inf
7/1 (Exit - Main Road Lane 1)	Infinite Saturation Flow						Inf	Inf
8/1 (Exit - A12 SB Lane 1)	Infinite Saturation Flow						Inf	Inf
8/2 (Exit - A12 SB Lane 2)	Infinite Saturation Flow						Inf	Inf
9/1 (Exit - A1214 Lane 1)	Infinite Saturation Flow						Inf	Inf
10/1 (Exit - Park and Ride Lane 1)	Infinite Saturation Flow						Inf	Inf
11/1 (A12 SB Circ)	4.90	0.00	Y	Arm 7 Ahead	Inf	100.0 %	2105	2105
11/2 (A12 SB Circ)	4.90	0.00	N	Arm 12 Right	Inf	100.0 %	2245	2245
11/3 (A12 SB Circ)	4.70	0.00	Y	Arm 12 Right	Inf	100.0 %	2085	2085

Full Input Data And Results

12/1 (Main Road Circ)	4.40	0.00	Y	Arm 8 Ahead	Inf	100.0 %	2055	2055
12/2 (Main Road Circ)	4.40	0.00	Y	Arm 8 Ahead	Inf	100.0 %	2055	2055
12/3 (Main Road Circ)	3.80	0.00	Y	Arm 13 Right	Inf	100.0 %	1995	1995
13/1 (A12 NB Circ)	4.40	0.00	Y	Arm 9 Ahead	Inf	100.0 %	2055	2055
13/2 (A12 NB Circ)	4.40	0.00	Y	Arm 14 Right	Inf	100.0 %	2055	2055
14/1 (A1214 Circ)	4.60	0.00	Y	Arm 10 Ahead	Inf	100.0 %	2075	2075
14/2 (A1214 Circ)	4.40	0.00	N	Arm 15 Right	Inf	100.0 %	2195	2195
14/3 (A1214 Circ)	4.40	0.00	Y	Arm 15 Right	Inf	100.0 %	2055	2055
15/1 (Park and Ride Circ)	4.90	0.00	Y	Arm 6 Ahead	Inf	100.0 %	2105	2105
15/2 (Park and Ride Circ)	4.90	0.00	N	Arm 6 Ahead	Inf	77.2 %	2245	2245
				Arm 11 Right	Inf	22.8 %		
15/3 (Park and Ride Circ)	4.90	0.00	N	Arm 11 Right	Inf	100.0 %	2245	2245
15/4 (Park and Ride Circ)	4.90	0.00	Y	Arm 11 Right	Inf	100.0 %	2105	2105

Scenario 2: '2024 Base + Com Dev - PM Peak' (FG2: '2024 Base + Com Dev - PM Peak', Plan 1: 'Network Control Plan 1')

Traffic Flows, Desired

Desired Flow :

	Destination						
	A	B	C	D	E	Tot.	
Origin	A	0	10	966	232	4	1212
B	38	0	121	25	0	184	
C	1000	125	0	377	4	1506	
D	253	38	366	0	4	661	
E	0	0	0	0	0	0	
Tot.	1291	173	1453	634	12	3563	

Full Input Data And Results

Traffic Lane Flows

Lane	Scenario 2: 2024 Base + Com Dev - PM Peak
Junction: A12/A1214/Main Road	
1/1	447
1/2 (with short)	765(In) 529(Out)
1/3 (short)	236
2/1 (short)	121
2/2 (with short)	184(In) 63(Out)
3/1 (short)	381
3/2 (with short)	959(In) 578(Out)
3/3	547
4/1	187
4/2 (with short)	474(In) 108(Out)
4/3 (short)	366
5/1 (short)	0
5/2 (with short)	0(In) 0(Out)
6/1	783
6/2	508
7/1	173
8/1	749
8/2	704
9/1	634
10/1	12
11/1	163
11/2	191
11/3	175
12/1	628
12/2	704
12/3	236
13/1	257
13/2	42
14/1	8
14/2	600
14/3	563
15/1	783
15/2	671

Full Input Data And Results

15/3	191
15/4	175

Full Input Data And Results

Lane Saturation Flows

Junction: A12/A1214/Main Road								
Lane	Lane Width (m)	Gradient	Nearside Lane	Allowed Turns	Turning Radius (m)	Turning Prop.	Sat Flow (PCU/Hr)	Flared Sat Flow (PCU/Hr)
1/1 (A12 SB)	3.40	0.00	Y	Arm 7 Left	Inf	2.2 %	1955	1955
				Arm 12 Ahead	Inf	97.8 %		
1/2 (A12 SB)	3.50	0.00	N	Arm 12 Ahead	Inf	100.0 %	2105	2105
1/3 (A12 SB)	3.60	0.00	Y	Arm 12 Ahead	Inf	100.0 %	1975	1975
2/1 (Main Road)	4.00	0.00	Y	Arm 8 Left	Inf	100.0 %	2015	2015
2/2 (Main Road)	4.00	0.00	Y	Arm 13 Ahead	Inf	100.0 %	2015	2015
3/1 (A12 NB)	3.80	0.00	Y	Arm 9 Left	Inf	99.0 %	1995	1995
				Arm 14 Ahead	Inf	1.0 %		
3/2 (A12 NB)	3.60	0.00	N	Arm 14 Ahead	Inf	100.0 %	2115	2115
3/3 (A12 NB)	3.70	0.00	Y	Arm 14 Ahead	Inf	100.0 %	1985	1985
4/1 (A1214)	4.10	0.00	Y	Arm 10 U-Turn	Inf	2.1 %	2025	2025
				Arm 15 Left	Inf	97.9 %		
4/2 (A1214)	4.10	0.00	N	Arm 15 Left	Inf	100.0 %	2165	2165
4/3 (A1214)	4.20	0.00	Y	Arm 15 Left	Inf	100.0 %	2035	2035
5/1 (Park and Ride Exit)	4.10	0.00	Y	Arm 6 Left	Inf	0.0 %	2025	2025
5/2 (Park and Ride Exit)	4.00	0.00	Y	Arm 11 Ahead	Inf	0.0 %	2015	2015
6/1 (Exit - A12 NB Lane 1)	Infinite Saturation Flow						Inf	Inf
6/2 (Exit - A12 NB Lane 2)	Infinite Saturation Flow						Inf	Inf
7/1 (Exit - Main Road Lane 1)	Infinite Saturation Flow						Inf	Inf
8/1 (Exit - A12 SB Lane 1)	Infinite Saturation Flow						Inf	Inf
8/2 (Exit - A12 SB Lane 2)	Infinite Saturation Flow						Inf	Inf
9/1 (Exit - A1214 Lane 1)	Infinite Saturation Flow						Inf	Inf
10/1 (Exit - Park and Ride Lane 1)	Infinite Saturation Flow						Inf	Inf
11/1 (A12 SB Circ)	4.90	0.00	Y	Arm 7 Ahead	Inf	100.0 %	2105	2105
11/2 (A12 SB Circ)	4.90	0.00	N	Arm 12 Right	Inf	100.0 %	2245	2245
11/3 (A12 SB Circ)	4.70	0.00	Y	Arm 12 Right	Inf	100.0 %	2085	2085

Full Input Data And Results

12/1 (Main Road Circ)	4.40	0.00	Y	Arm 8 Ahead	Inf	100.0 %	2055	2055
12/2 (Main Road Circ)	4.40	0.00	Y	Arm 8 Ahead	Inf	100.0 %	2055	2055
12/3 (Main Road Circ)	3.80	0.00	Y	Arm 13 Right	Inf	100.0 %	1995	1995
13/1 (A12 NB Circ)	4.40	0.00	Y	Arm 9 Ahead	Inf	100.0 %	2055	2055
13/2 (A12 NB Circ)	4.40	0.00	Y	Arm 14 Right	Inf	100.0 %	2055	2055
14/1 (A1214 Circ)	4.60	0.00	Y	Arm 10 Ahead	Inf	100.0 %	2075	2075
14/2 (A1214 Circ)	4.40	0.00	N	Arm 15 Right	Inf	100.0 %	2195	2195
14/3 (A1214 Circ)	4.40	0.00	Y	Arm 15 Right	Inf	100.0 %	2055	2055
15/1 (Park and Ride Circ)	4.90	0.00	Y	Arm 6 Ahead	Inf	100.0 %	2105	2105
15/2 (Park and Ride Circ)	4.90	0.00	N	Arm 6 Ahead	Inf	75.7 %	2245	2245
				Arm 11 Right	Inf	24.3 %		
15/3 (Park and Ride Circ)	4.90	0.00	N	Arm 11 Right	Inf	100.0 %	2245	2245
15/4 (Park and Ride Circ)	4.90	0.00	Y	Arm 11 Right	Inf	100.0 %	2105	2105

Scenario 3: '2024 Base + Com Dev + EA3 - PM Peak' (FG3: '2024 Base + Com Dev + EA3 - PM Peak', Plan 1: 'Network Control Plan 1')

Traffic Flows, Desired

Desired Flow :

	Destination						
	A	B	C	D	E	Tot.	
Origin	A	0	10	979	237	4	1230
B	38	0	121	25	0	184	
C	1014	125	0	382	4	1525	
D	253	38	366	0	4	661	
E	0	0	0	0	0	0	
Tot.	1305	173	1466	644	12	3600	

Full Input Data And Results

Traffic Lane Flows

Lane	Scenario 3: 2024 Base + Com Dev + EA3 - PM Peak
Junction: A12/A1214/Main Road	
1/1	454
1/2 (with short)	776(In) 535(Out)
1/3 (short)	241
2/1 (short)	121
2/2 (with short)	184(In) 63(Out)
3/1 (short)	386
3/2 (with short)	971(In) 585(Out)
3/3	554
4/1	187
4/2 (with short)	474(In) 108(Out)
4/3 (short)	366
5/1 (short)	0
5/2 (with short)	0(In) 0(Out)
6/1	790
6/2	515
7/1	173
8/1	756
8/2	710
9/1	644
10/1	12
11/1	163
11/2	191
11/3	175
12/1	635
12/2	710
12/3	241
13/1	262
13/2	42
14/1	8
14/2	607
14/3	570
15/1	790
15/2	678

Full Input Data And Results

15/3	191
15/4	175

Full Input Data And Results

Lane Saturation Flows

Junction: A12/A1214/Main Road								
Lane	Lane Width (m)	Gradient	Nearside Lane	Allowed Turns	Turning Radius (m)	Turning Prop.	Sat Flow (PCU/Hr)	Flared Sat Flow (PCU/Hr)
1/1 (A12 SB)	3.40	0.00	Y	Arm 7 Left	Inf	2.2 %	1955	1955
				Arm 12 Ahead	Inf	97.8 %		
1/2 (A12 SB)	3.50	0.00	N	Arm 12 Ahead	Inf	100.0 %	2105	2105
1/3 (A12 SB)	3.60	0.00	Y	Arm 12 Ahead	Inf	100.0 %	1975	1975
2/1 (Main Road)	4.00	0.00	Y	Arm 8 Left	Inf	100.0 %	2015	2015
2/2 (Main Road)	4.00	0.00	Y	Arm 13 Ahead	Inf	100.0 %	2015	2015
3/1 (A12 NB)	3.80	0.00	Y	Arm 9 Left	Inf	99.0 %	1995	1995
				Arm 14 Ahead	Inf	1.0 %		
3/2 (A12 NB)	3.60	0.00	N	Arm 14 Ahead	Inf	100.0 %	2115	2115
3/3 (A12 NB)	3.70	0.00	Y	Arm 14 Ahead	Inf	100.0 %	1985	1985
4/1 (A1214)	4.10	0.00	Y	Arm 10 U-Turn	Inf	2.1 %	2025	2025
				Arm 15 Left	Inf	97.9 %		
4/2 (A1214)	4.10	0.00	N	Arm 15 Left	Inf	100.0 %	2165	2165
4/3 (A1214)	4.20	0.00	Y	Arm 15 Left	Inf	100.0 %	2035	2035
5/1 (Park and Ride Exit)	4.10	0.00	Y	Arm 6 Left	Inf	0.0 %	2025	2025
5/2 (Park and Ride Exit)	4.00	0.00	Y	Arm 11 Ahead	Inf	0.0 %	2015	2015
6/1 (Exit - A12 NB Lane 1)	Infinite Saturation Flow						Inf	Inf
6/2 (Exit - A12 NB Lane 2)	Infinite Saturation Flow						Inf	Inf
7/1 (Exit - Main Road Lane 1)	Infinite Saturation Flow						Inf	Inf
8/1 (Exit - A12 SB Lane 1)	Infinite Saturation Flow						Inf	Inf
8/2 (Exit - A12 SB Lane 2)	Infinite Saturation Flow						Inf	Inf
9/1 (Exit - A1214 Lane 1)	Infinite Saturation Flow						Inf	Inf
10/1 (Exit - Park and Ride Lane 1)	Infinite Saturation Flow						Inf	Inf
11/1 (A12 SB Circ)	4.90	0.00	Y	Arm 7 Ahead	Inf	100.0 %	2105	2105
11/2 (A12 SB Circ)	4.90	0.00	N	Arm 12 Right	Inf	100.0 %	2245	2245
11/3 (A12 SB Circ)	4.70	0.00	Y	Arm 12 Right	Inf	100.0 %	2085	2085

Full Input Data And Results

12/1 (Main Road Circ)	4.40	0.00	Y	Arm 8 Ahead	Inf	100.0 %	2055	2055
12/2 (Main Road Circ)	4.40	0.00	Y	Arm 8 Ahead	Inf	100.0 %	2055	2055
12/3 (Main Road Circ)	3.80	0.00	Y	Arm 13 Right	Inf	100.0 %	1995	1995
13/1 (A12 NB Circ)	4.40	0.00	Y	Arm 9 Ahead	Inf	100.0 %	2055	2055
13/2 (A12 NB Circ)	4.40	0.00	Y	Arm 14 Right	Inf	100.0 %	2055	2055
14/1 (A1214 Circ)	4.60	0.00	Y	Arm 10 Ahead	Inf	100.0 %	2075	2075
14/2 (A1214 Circ)	4.40	0.00	N	Arm 15 Right	Inf	100.0 %	2195	2195
14/3 (A1214 Circ)	4.40	0.00	Y	Arm 15 Right	Inf	100.0 %	2055	2055
15/1 (Park and Ride Circ)	4.90	0.00	Y	Arm 6 Ahead	Inf	100.0 %	2105	2105
15/2 (Park and Ride Circ)	4.90	0.00	N	Arm 6 Ahead	Inf	76.0 %	2245	2245
				Arm 11 Right	Inf	24.0 %		
15/3 (Park and Ride Circ)	4.90	0.00	N	Arm 11 Right	Inf	100.0 %	2245	2245
15/4 (Park and Ride Circ)	4.90	0.00	Y	Arm 11 Right	Inf	100.0 %	2105	2105

Scenario 1: '2017 Survey (No Park and Ride) - PM Peak' (FG1: '2017 Survey (No Park and Ride) - PM Peak', Plan 1: 'Network Control Plan 1')

Stage Sequence Diagram

Stage Stream: 1

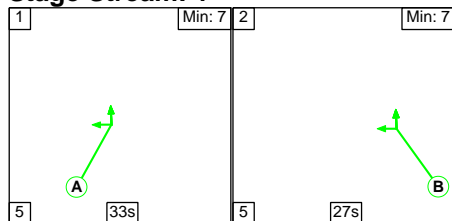

Stage Stream: 2

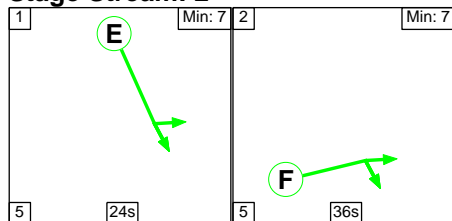

Stage Stream: 3

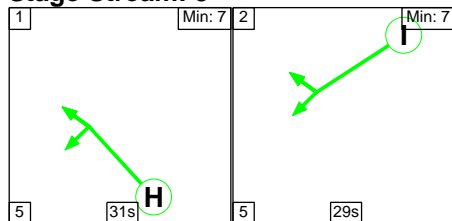

Full Input Data And Results

Stage Timings

Stage Stream: 1

Stage	1	2
Duration	33	27
Change Point	13	51

Stage Stream: 2

Stage	1	2
Duration	24	36
Change Point	56	15

Stage Stream: 3

Stage	1	2
Duration	31	29
Change Point	14	50

Signal Timings Diagram

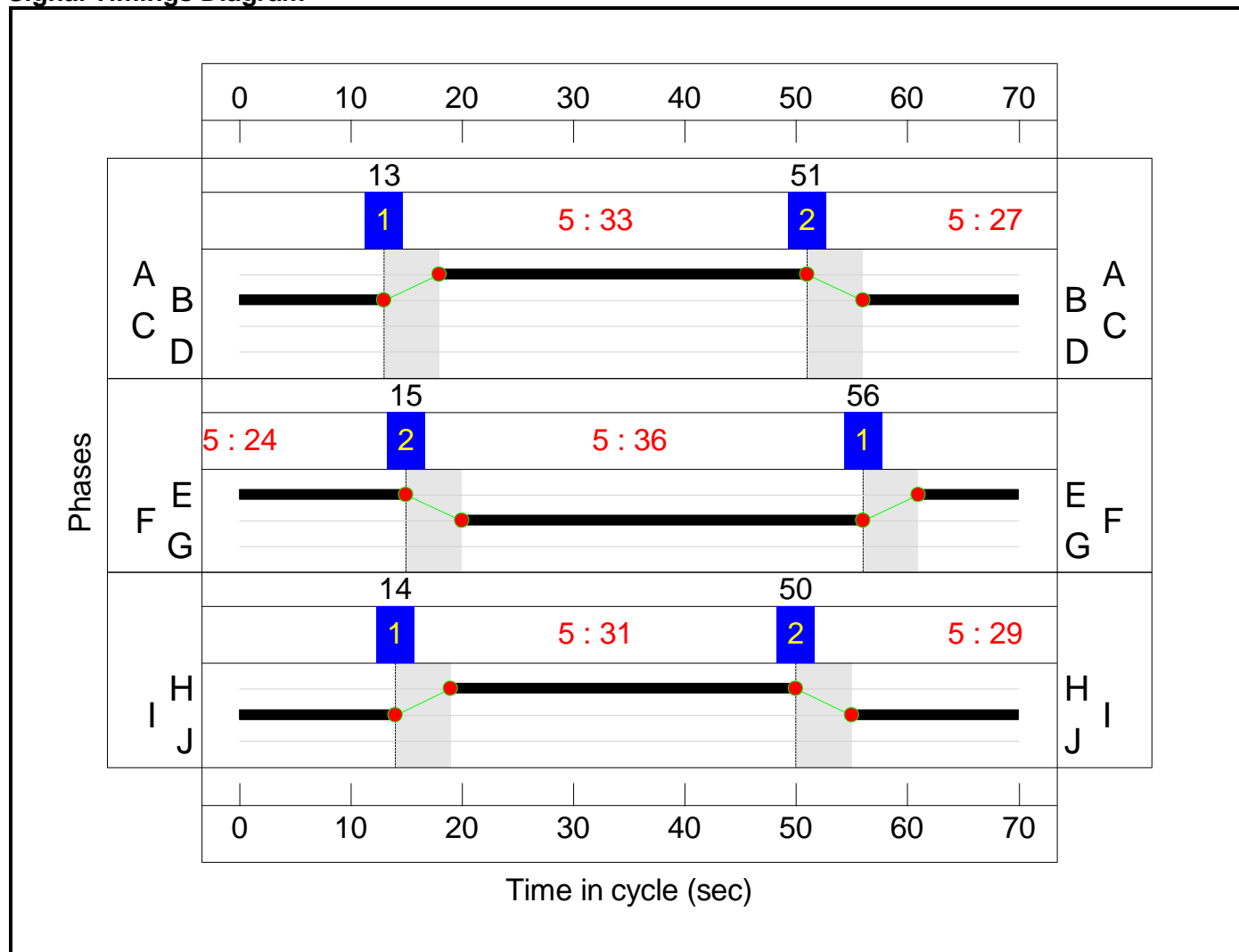

Full Input Data And Results
Network Layout Diagram

Full Input Data And Results

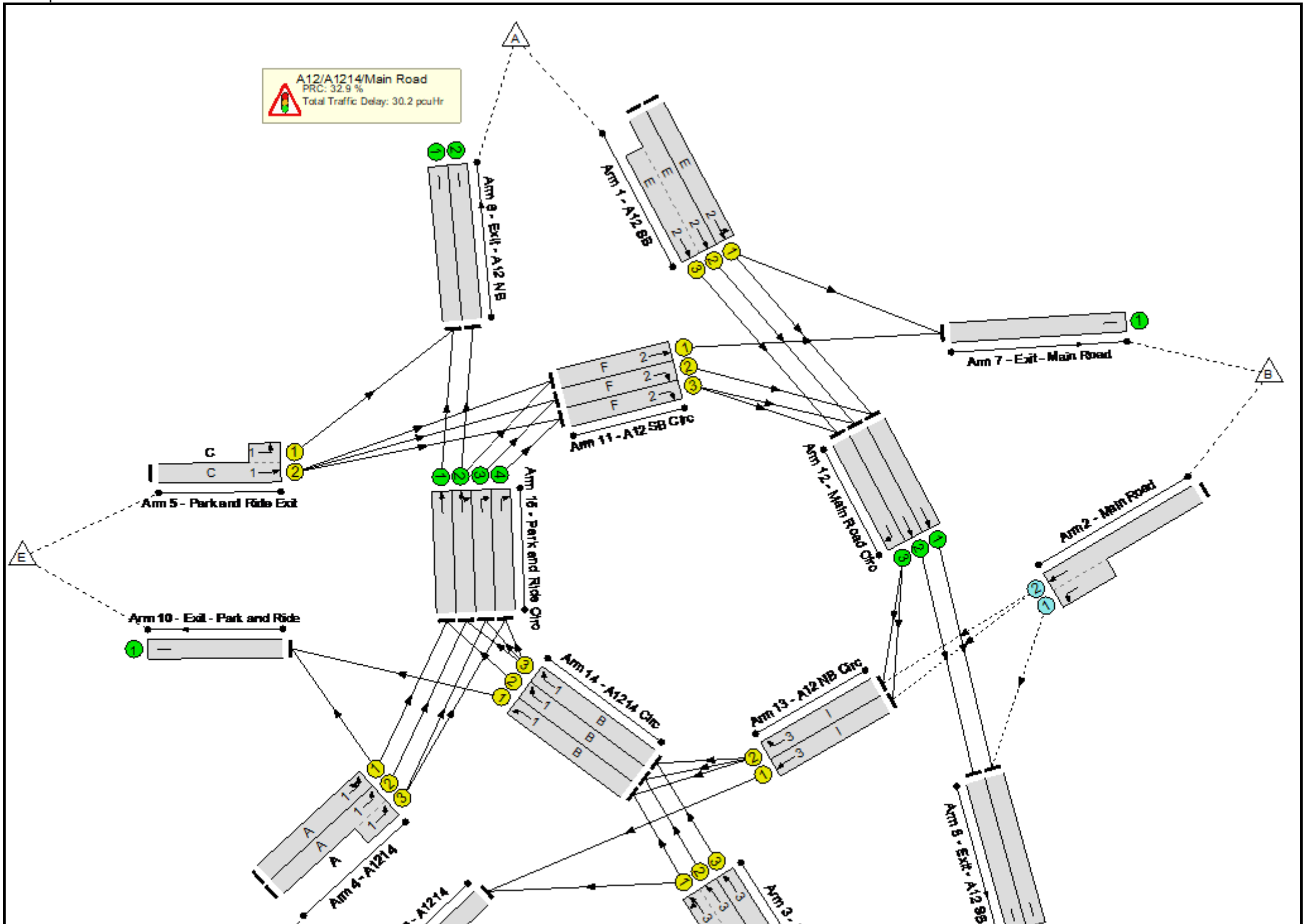

Full Input Data And Results

Full Input Data And Results

Network Results

Item	Lane Description	Lane Type	Controller Stream	Position In Filtered Route	Full Phase	Arrow Phase	Num Greens	Total Green (s)	Arrow Green (s)	Demand Flow (pcu)	Sat Flow (pcu/Hr)	Capacity (pcu)	Deg Sat (%)
Network	-	-	N/A	-	-		-	-	-	-	-	-	67.7%
A12/A1214/Main Road	-	-	N/A	-	-		-	-	-	-	-	-	67.7%
1/1	A12 SB Left Ahead	U	2	N/A	E		1	24	-	413	1955	698	59.2%
1/2+1/3	A12 SB Ahead	U	2	N/A	E		1	24	-	725	2105:1975	1070	67.7%
2/2+2/1	Main Road Left Ahead	O	N/A	N/A	-		-	-	-	168	2015:2015	875	19.2%
3/2+3/1	A12 NB Left Ahead	U	3	N/A	H		1	31	-	900	2115:1995	1479	60.8%
3/3	A12 NB Ahead	U	3	N/A	H		1	31	-	512	1985	907	56.4%
4/1	A1214 U-Turn Left	U	1	N/A	A		1	33	-	172	2025	984	17.5%
4/2+4/3	A1214 Left	U	1	N/A	A		1	33	-	449	2165:2035	1067	42.1%
5/2+5/1	Park and Ride Exit Left Ahead	U	1	N/A	C		0	0	-	0	2015:2025	0	0.0%
6/1	Exit - A12 NB	U	N/A	N/A	-		-	-	-	730	Inf	Inf	0.0%
6/2	Exit - A12 NB	U	N/A	N/A	-		-	-	-	490	Inf	Inf	0.0%
7/1	Exit - Main Road	U	N/A	N/A	-		-	-	-	154	Inf	Inf	0.0%
8/1	Exit - A12 SB	U	N/A	N/A	-		-	-	-	692	Inf	Inf	0.0%
8/2	Exit - A12 SB	U	N/A	N/A	-		-	-	-	662	Inf	Inf	0.0%
9/1	Exit - A1214	U	N/A	N/A	-		-	-	-	599	Inf	Inf	0.0%
10/1	Exit - Park and Ride	U	N/A	N/A	-		-	-	-	12	Inf	Inf	0.0%
11/1	A12 SB Circ Ahead	U	2	N/A	F		1	36	-	145	2105	1113	13.0%
11/2	A12 SB Circ Right	U	2	N/A	F		1	36	-	178	2245	1187	15.0%
11/3	A12 SB Circ Right	U	2	N/A	F		1	36	-	163	2085	1102	14.8%

Full Input Data And Results

12/1	Main Road Circ Ahead	U	N/A	N/A	-		-	-	-	582	2055	2055	28.3%
12/2	Main Road Circ Ahead	U	N/A	N/A	-		-	-	-	662	2055	2055	32.2%
12/3	Main Road Circ Right	U	N/A	N/A	-		-	-	-	226	1995	1995	11.3%
13/1	A12 NB Circ Ahead	U	3	N/A	I		1	29	-	245	2055	881	27.8%
13/2	A12 NB Circ Right	U	3	N/A	I		1	29	-	39	2055	881	4.4%
14/1	A1214 Circ Ahead	U	1	N/A	B		1	27	-	8	2075	830	1.0%
14/2	A1214 Circ Right	U	1	N/A	B		1	27	-	562	2195	878	64.0%
14/3	A1214 Circ Right	U	1	N/A	B		1	27	-	527	2055	822	64.1%
15/1	Park and Ride Circ Ahead	U	N/A	N/A	-		-	-	-	730	2105	2105	34.7%
15/2	Park and Ride Circ Ahead Right	U	N/A	N/A	-		-	-	-	635	2245	2245	28.3%
15/3	Park and Ride Circ Right	U	N/A	N/A	-		-	-	-	178	2245	2245	7.9%
15/4	Park and Ride Circ Right	U	N/A	N/A	-		-	-	-	163	2105	2105	7.7%

Full Input Data And Results

Item	Arriving (pcu)	Leaving (pcu)	Turners In Gaps (pcu)	Turners When Unopposed (pcu)	Turners In Intergreen (pcu)	Uniform Delay (pcuHr)	Rand + Oversat Delay (pcuHr)	Storage Area Uniform Delay (pcuHr)	Total Delay (pcuHr)	Av. Delay Per PCU (s/pcu)	Max. Back of Uniform Queue (pcu)	Rand + Oversat Queue (pcu)	Mean Max Queue (pcu)
Network	-	-	336	0	0	23.2	7.1	0.0	30.2	-	-	-	-
A12/A1214/Main Road	-	-	336	0	0	23.2	7.1	0.0	30.2	-	-	-	-
1/1	413	413	-	-	-	2.1	0.7	-	2.8	24.6	6.5	0.7	7.3
1/2+1/3	725	725	-	-	-	3.7	1.0	-	4.7	23.3	8.0	1.0	9.1
2/2+2/1	168	168	336	0	0	0.1	0.1	-	0.2	4.1	0.4	0.1	0.5
3/2+3/1	900	900	-	-	-	3.3	0.8	-	4.1	16.5	7.7	0.8	8.5
3/3	512	512	-	-	-	2.0	0.6	-	2.6	18.4	7.3	0.6	7.9
4/1	172	172	-	-	-	0.5	0.1	-	0.6	12.4	1.9	0.1	2.0
4/2+4/3	449	449	-	-	-	1.4	0.4	-	1.7	13.8	4.3	0.4	4.7
5/2+5/1	0	0	-	-	-	0.0	0.0	-	0.0	0.0	0.0	0.0	0.0
6/1	730	730	-	-	-	0.0	0.0	-	0.0	0.0	0.0	0.0	0.0
6/2	490	490	-	-	-	0.0	0.0	-	0.0	0.0	0.0	0.0	0.0
7/1	154	154	-	-	-	0.0	0.0	-	0.0	0.0	0.0	0.0	0.0
8/1	692	692	-	-	-	0.0	0.0	-	0.0	0.0	0.0	0.0	0.0
8/2	662	662	-	-	-	0.0	0.0	-	0.0	0.0	0.0	0.0	0.0
9/1	599	599	-	-	-	0.0	0.0	-	0.0	0.0	0.0	0.0	0.0
10/1	12	12	-	-	-	0.0	0.0	-	0.0	0.0	0.0	0.0	0.0
11/1	145	145	-	-	-	0.6	0.1	-	0.7	17.8	2.2	0.1	2.3
11/2	178	178	-	-	-	0.0	0.1	-	0.1	2.6	0.1	0.1	0.2
11/3	163	163	-	-	-	0.0	0.1	-	0.1	2.7	0.1	0.1	0.2
12/1	582	582	-	-	-	0.0	0.2	-	0.2	1.2	0.0	0.2	0.2
12/2	662	662	-	-	-	0.0	0.2	-	0.2	1.3	3.5	0.2	3.7
12/3	226	226	-	-	-	0.0	0.1	-	0.1	1.0	0.0	0.1	0.1
13/1	245	245	-	-	-	0.5	0.2	-	0.7	10.1	1.1	0.2	1.3
13/2	39	39	-	-	-	0.2	0.0	-	0.2	18.3	0.5	0.0	0.5
14/1	8	8	-	-	-	0.0	0.0	-	0.0	16.2	0.1	0.0	0.1

Full Input Data And Results

14/2	562	562	-	-	-	4.5	0.9	-	5.4	34.4	10.9	0.9	11.8	
14/3	527	527	-	-	-	4.2	0.9	-	5.1	35.0	10.2	0.9	11.1	
15/1	730	730	-	-	-	0.0	0.3	-	0.3	1.5	8.5	0.3	8.7	
15/2	635	635	-	-	-	0.0	0.2	-	0.2	1.1	0.0	0.2	0.2	
15/3	178	178	-	-	-	0.0	0.0	-	0.0	0.9	0.0	0.0	0.0	
15/4	163	163	-	-	-	0.0	0.0	-	0.0	0.9	0.0	0.0	0.0	
			C1	Stream: 1 PRC for Signalled Lanes (%)	40.4	Total Delay for Signalled Lanes (pcuHr):			12.84	Cycle Time (s):		70		
			C1	Stream: 2 PRC for Signalled Lanes (%)	32.9	Total Delay for Signalled Lanes (pcuHr):			8.49	Cycle Time (s):		70		
			C1	Stream: 3 PRC for Signalled Lanes (%)	47.9	Total Delay for Signalled Lanes (pcuHr):			7.62	Cycle Time (s):		70		
				PRC Over All Lanes (%)	32.9	Total Delay Over All Lanes(pcuHr):			30.22					

Full Input Data And Results

Scenario 2: '2024 Base + Com Dev - PM Peak' (FG2: '2024 Base + Com Dev - PM Peak', Plan 1: 'Network Control Plan 1')

Stage Sequence Diagram

Stage Stream: 1

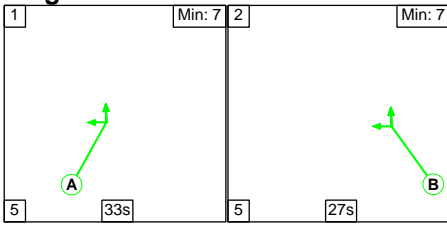

Stage Stream: 2

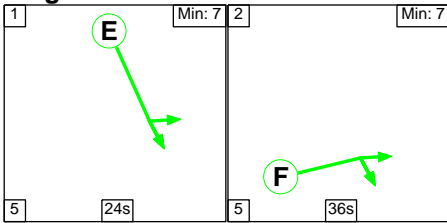

Stage Stream: 3

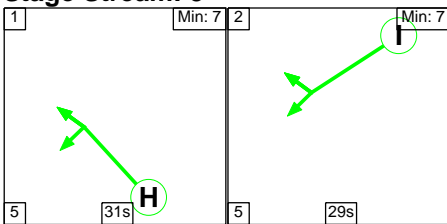

Stage Timings

Stage Stream: 1

Stage	1	2
Duration	33	27
Change Point	13	51

Stage Stream: 2

Stage	1	2
Duration	24	36
Change Point	56	15

Stage Stream: 3

Stage	1	2
Duration	31	29
Change Point	14	50

Signal Timings Diagram

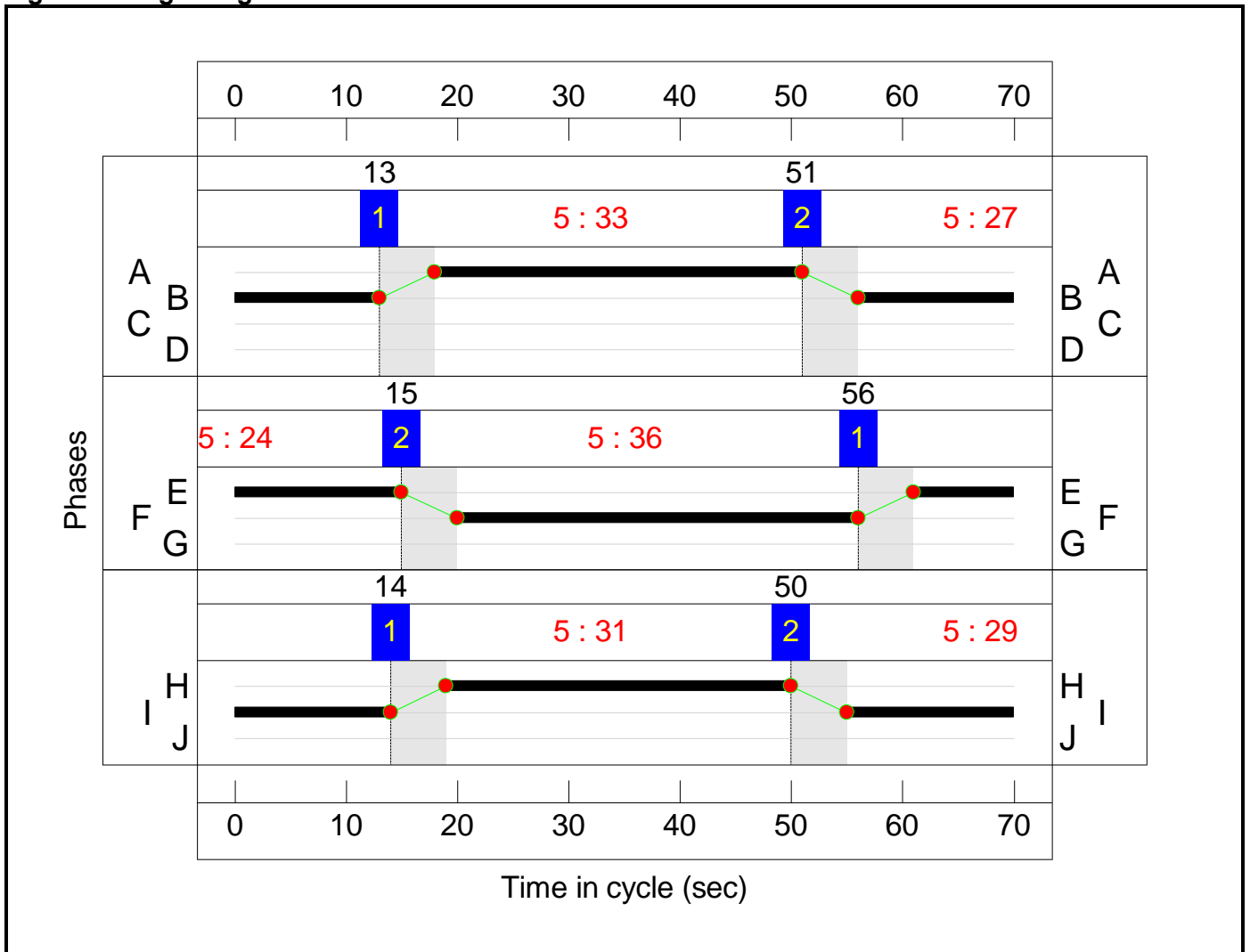

Full Input Data And Results
Network Layout Diagram

Full Input Data And Results

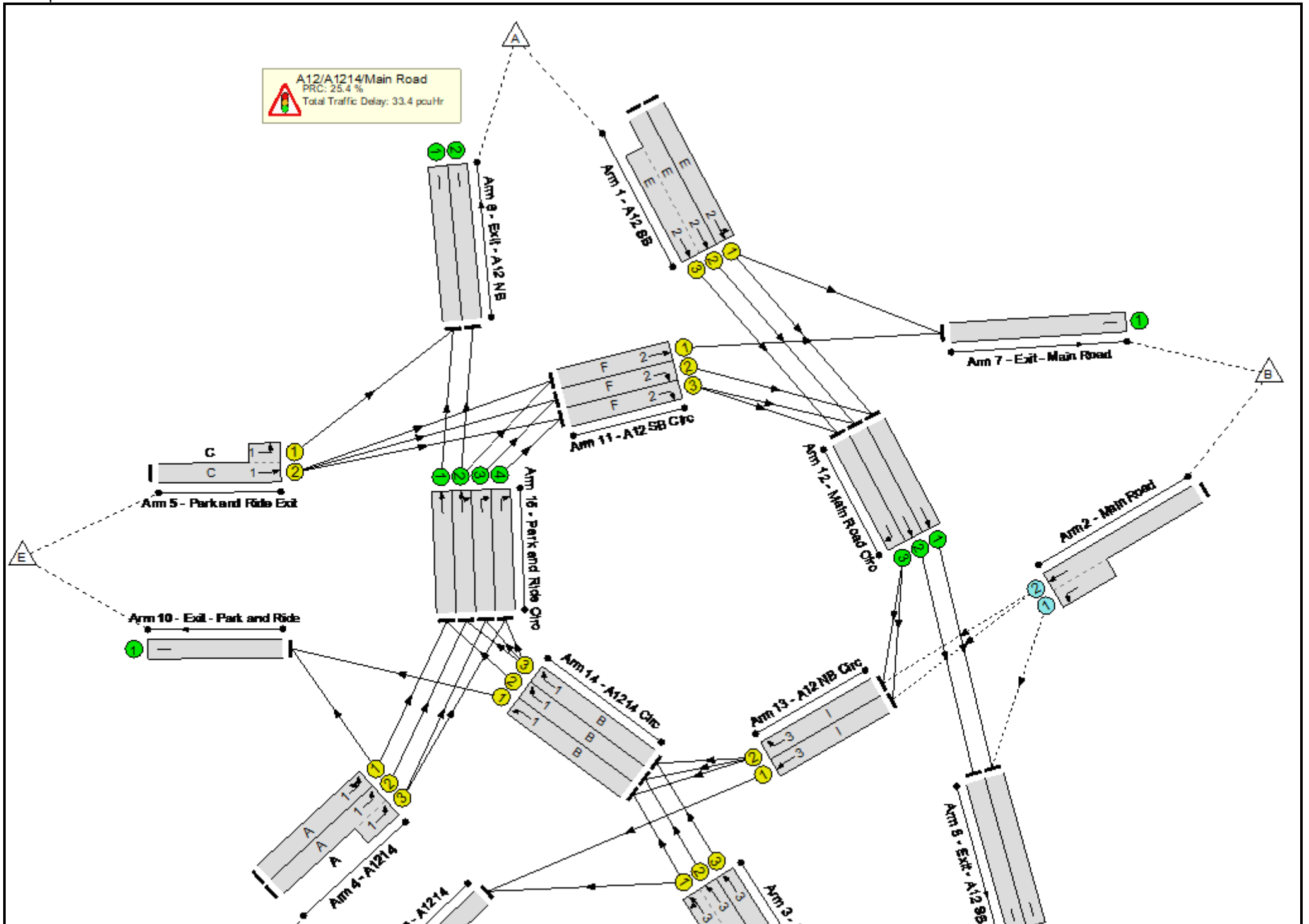

Full Input Data And Results

Full Input Data And Results

Network Results

Item	Lane Description	Lane Type	Controller Stream	Position In Filtered Route	Full Phase	Arrow Phase	Num Greens	Total Green (s)	Arrow Green (s)	Demand Flow (pcu)	Sat Flow (pcu/Hr)	Capacity (pcu)	Deg Sat (%)
Network	-	-	N/A	-	-		-	-	-	-	-	-	71.8%
A12/A1214/Main Road	-	-	N/A	-	-		-	-	-	-	-	-	71.8%
1/1	A12 SB Left Ahead	U	2	N/A	E		1	24	-	447	1955	698	64.0%
1/2+1/3	A12 SB Ahead	U	2	N/A	E		1	24	-	765	2105:1975	1066	71.8%
2/2+2/1	Main Road Left Ahead	O	N/A	N/A	-		-	-	-	184	2015:2015	838	21.9%
3/2+3/1	A12 NB Left Ahead	U	3	N/A	H		1	31	-	959	2115:1995	1478	64.9%
3/3	A12 NB Ahead	U	3	N/A	H		1	31	-	547	1985	907	60.3%
4/1	A1214 U-Turn Left	U	1	N/A	A		1	33	-	187	2025	984	19.0%
4/2+4/3	A1214 Left	U	1	N/A	A		1	33	-	474	2165:2035	1063	44.6%
5/2+5/1	Park and Ride Exit Left Ahead	U	1	N/A	C		0	0	-	0	2015:2025	0	0.0%
6/1	Exit - A12 NB	U	N/A	N/A	-		-	-	-	783	Inf	Inf	0.0%
6/2	Exit - A12 NB	U	N/A	N/A	-		-	-	-	508	Inf	Inf	0.0%
7/1	Exit - Main Road	U	N/A	N/A	-		-	-	-	173	Inf	Inf	0.0%
8/1	Exit - A12 SB	U	N/A	N/A	-		-	-	-	749	Inf	Inf	0.0%
8/2	Exit - A12 SB	U	N/A	N/A	-		-	-	-	704	Inf	Inf	0.0%
9/1	Exit - A1214	U	N/A	N/A	-		-	-	-	634	Inf	Inf	0.0%
10/1	Exit - Park and Ride	U	N/A	N/A	-		-	-	-	12	Inf	Inf	0.0%
11/1	A12 SB Circ Ahead	U	2	N/A	F		1	36	-	163	2105	1113	14.6%
11/2	A12 SB Circ Right	U	2	N/A	F		1	36	-	191	2245	1187	16.1%
11/3	A12 SB Circ Right	U	2	N/A	F		1	36	-	175	2085	1102	15.9%

Full Input Data And Results

12/1	Main Road Circ Ahead	U	N/A	N/A	-		-	-	-	628	2055	2055	30.6%
12/2	Main Road Circ Ahead	U	N/A	N/A	-		-	-	-	704	2055	2055	34.3%
12/3	Main Road Circ Right	U	N/A	N/A	-		-	-	-	236	1995	1995	11.8%
13/1	A12 NB Circ Ahead	U	3	N/A	I		1	29	-	257	2055	881	29.2%
13/2	A12 NB Circ Right	U	3	N/A	I		1	29	-	42	2055	881	4.8%
14/1	A1214 Circ Ahead	U	1	N/A	B		1	27	-	8	2075	830	1.0%
14/2	A1214 Circ Right	U	1	N/A	B		1	27	-	600	2195	878	68.3%
14/3	A1214 Circ Right	U	1	N/A	B		1	27	-	563	2055	822	68.5%
15/1	Park and Ride Circ Ahead	U	N/A	N/A	-		-	-	-	783	2105	2105	37.2%
15/2	Park and Ride Circ Ahead Right	U	N/A	N/A	-		-	-	-	671	2245	2245	29.9%
15/3	Park and Ride Circ Right	U	N/A	N/A	-		-	-	-	191	2245	2245	8.5%
15/4	Park and Ride Circ Right	U	N/A	N/A	-		-	-	-	175	2105	2105	8.3%

Full Input Data And Results

Item	Arriving (pcu)	Leaving (pcu)	Turners In Gaps (pcu)	Turners When Unopposed (pcu)	Turners In Intergreen (pcu)	Uniform Delay (pcuHr)	Rand + Oversat Delay (pcuHr)	Storage Area Uniform Delay (pcuHr)	Total Delay (pcuHr)	Av. Delay Per PCU (s/pcu)	Max. Back of Uniform Queue (pcu)	Rand + Oversat Queue (pcu)	Mean Max Queue (pcu)
Network	-	-	368	0	0	25.1	8.3	0.0	33.4	-	-	-	-
A12/A1214/Main Road	-	-	368	0	0	25.1	8.3	0.0	33.4	-	-	-	-
1/1	447	447	-	-	-	2.3	0.9	-	3.2	25.9	7.2	0.9	8.1
1/2+1/3	765	765	-	-	-	3.9	1.3	-	5.2	24.4	8.8	1.3	10.1
2/2+2/1	184	184	368	0	0	0.1	0.1	-	0.2	4.7	0.5	0.1	0.6
3/2+3/1	959	959	-	-	-	3.6	0.9	-	4.5	17.1	8.3	0.9	9.3
3/3	547	547	-	-	-	2.2	0.8	-	2.9	19.2	7.9	0.8	8.7
4/1	187	187	-	-	-	0.5	0.1	-	0.6	12.5	2.0	0.1	2.1
4/2+4/3	474	474	-	-	-	1.5	0.4	-	1.9	14.1	4.8	0.4	5.3
5/2+5/1	0	0	-	-	-	0.0	0.0	-	0.0	0.0	0.0	0.0	0.0
6/1	783	783	-	-	-	0.0	0.0	-	0.0	0.0	0.0	0.0	0.0
6/2	508	508	-	-	-	0.0	0.0	-	0.0	0.0	0.0	0.0	0.0
7/1	173	173	-	-	-	0.0	0.0	-	0.0	0.0	0.0	0.0	0.0
8/1	749	749	-	-	-	0.0	0.0	-	0.0	0.0	0.0	0.0	0.0
8/2	704	704	-	-	-	0.0	0.0	-	0.0	0.0	0.0	0.0	0.0
9/1	634	634	-	-	-	0.0	0.0	-	0.0	0.0	0.0	0.0	0.0
10/1	12	12	-	-	-	0.0	0.0	-	0.0	0.0	0.0	0.0	0.0
11/1	163	163	-	-	-	0.7	0.1	-	0.8	17.6	2.5	0.1	2.5
11/2	191	191	-	-	-	0.0	0.1	-	0.1	2.6	0.1	0.1	0.2
11/3	175	175	-	-	-	0.0	0.1	-	0.1	2.7	0.1	0.1	0.2
12/1	628	628	-	-	-	0.0	0.2	-	0.2	1.3	0.0	0.2	0.2
12/2	704	704	-	-	-	0.0	0.3	-	0.3	1.3	4.1	0.3	4.3
12/3	236	236	-	-	-	0.0	0.1	-	0.1	1.0	0.0	0.1	0.1
13/1	257	257	-	-	-	0.5	0.2	-	0.7	10.1	1.2	0.2	1.4
13/2	42	42	-	-	-	0.2	0.0	-	0.2	17.8	0.6	0.0	0.6
14/1	8	8	-	-	-	0.0	0.0	-	0.0	16.2	0.1	0.0	0.1

Full Input Data And Results

14/2	600	600	-	-	-	4.8	1.1	-	5.9	35.4	11.7	1.1	12.7
14/3	563	563	-	-	-	4.6	1.1	-	5.6	36.1	10.9	1.1	12.0
15/1	783	783	-	-	-	0.0	0.3	-	0.3	1.5	9.4	0.3	9.7
15/2	671	671	-	-	-	0.0	0.2	-	0.2	1.1	0.0	0.2	0.2
15/3	191	191	-	-	-	0.0	0.0	-	0.0	0.9	0.0	0.0	0.0
15/4	175	175	-	-	-	0.0	0.0	-	0.0	0.9	0.0	0.0	0.0
			C1	Stream: 1 PRC for Signalled Lanes (%):	31.4	Total Delay for Signalled Lanes (pcuHr):			14.09	Cycle Time (s):		70	
			C1	Stream: 2 PRC for Signalled Lanes (%):	25.4	Total Delay for Signalled Lanes (pcuHr):			9.46	Cycle Time (s):		70	
			C1	Stream: 3 PRC for Signalled Lanes (%):	38.7	Total Delay for Signalled Lanes (pcuHr):			8.40	Cycle Time (s):		70	
				PRC Over All Lanes (%):	25.4	Total Delay Over All Lanes(pcuHr):			33.38				

Full Input Data And Results

Scenario 3: '2024 Base + Com Dev + EA3 - PM Peak' (FG3: '2024 Base + Com Dev + EA3 - PM Peak', Plan 1: 'Network Control Plan 1')

Stage Sequence Diagram

Stage Stream: 1

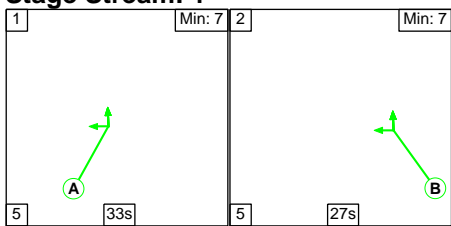

Stage Stream: 2

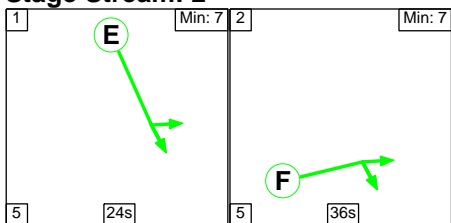

Stage Stream: 3

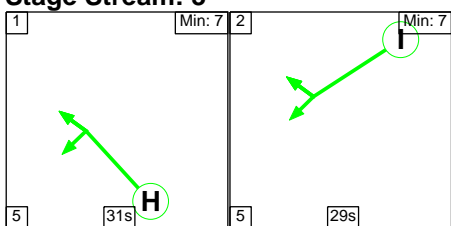

Stage Timings

Stage Stream: 1

Stage	1	2
Duration	33	27
Change Point	13	51

Stage Stream: 2

Stage	1	2
Duration	24	36
Change Point	56	15

Stage Stream: 3

Stage	1	2
Duration	31	29
Change Point	14	50

Signal Timings Diagram

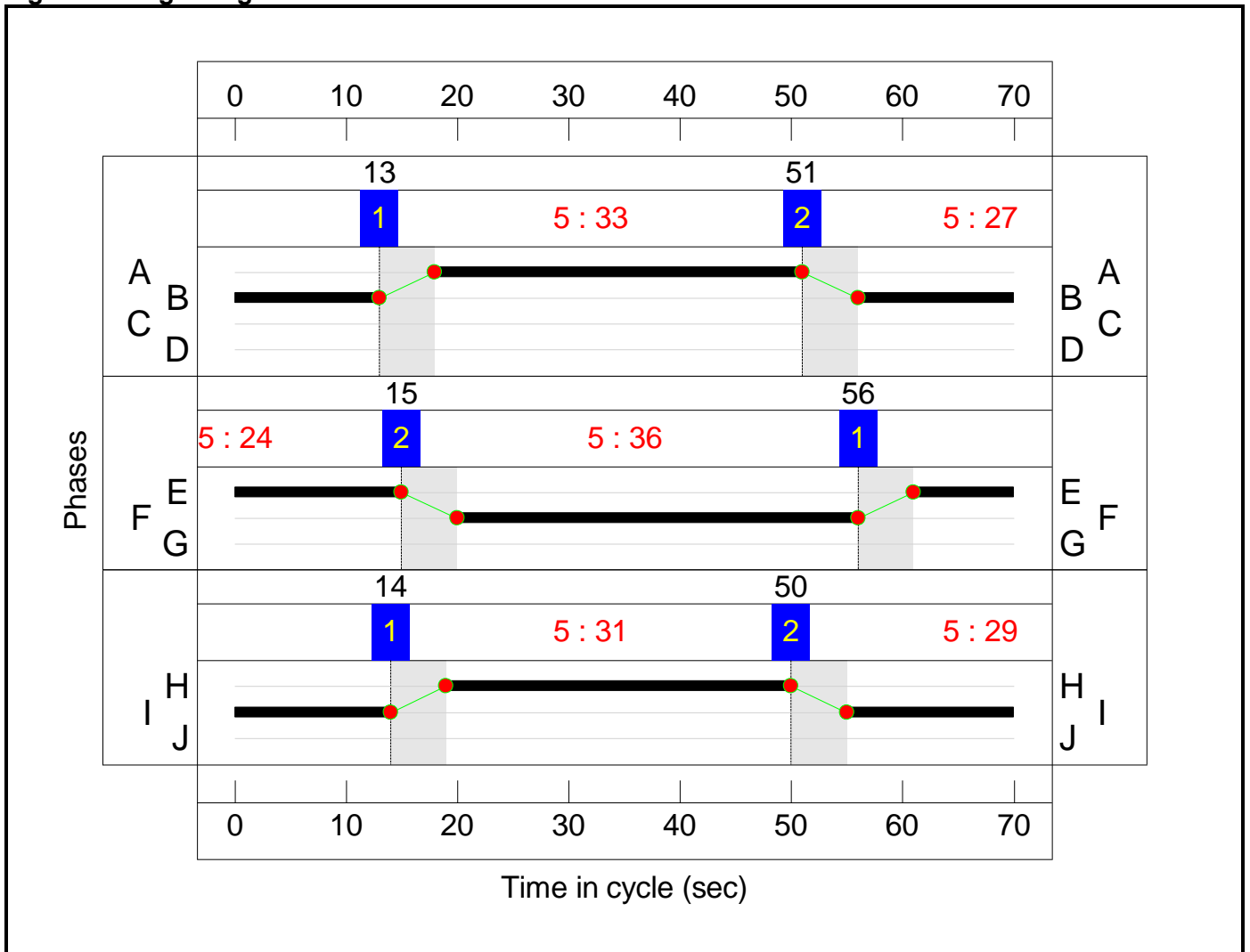

Full Input Data And Results
Network Layout Diagram

Full Input Data And Results

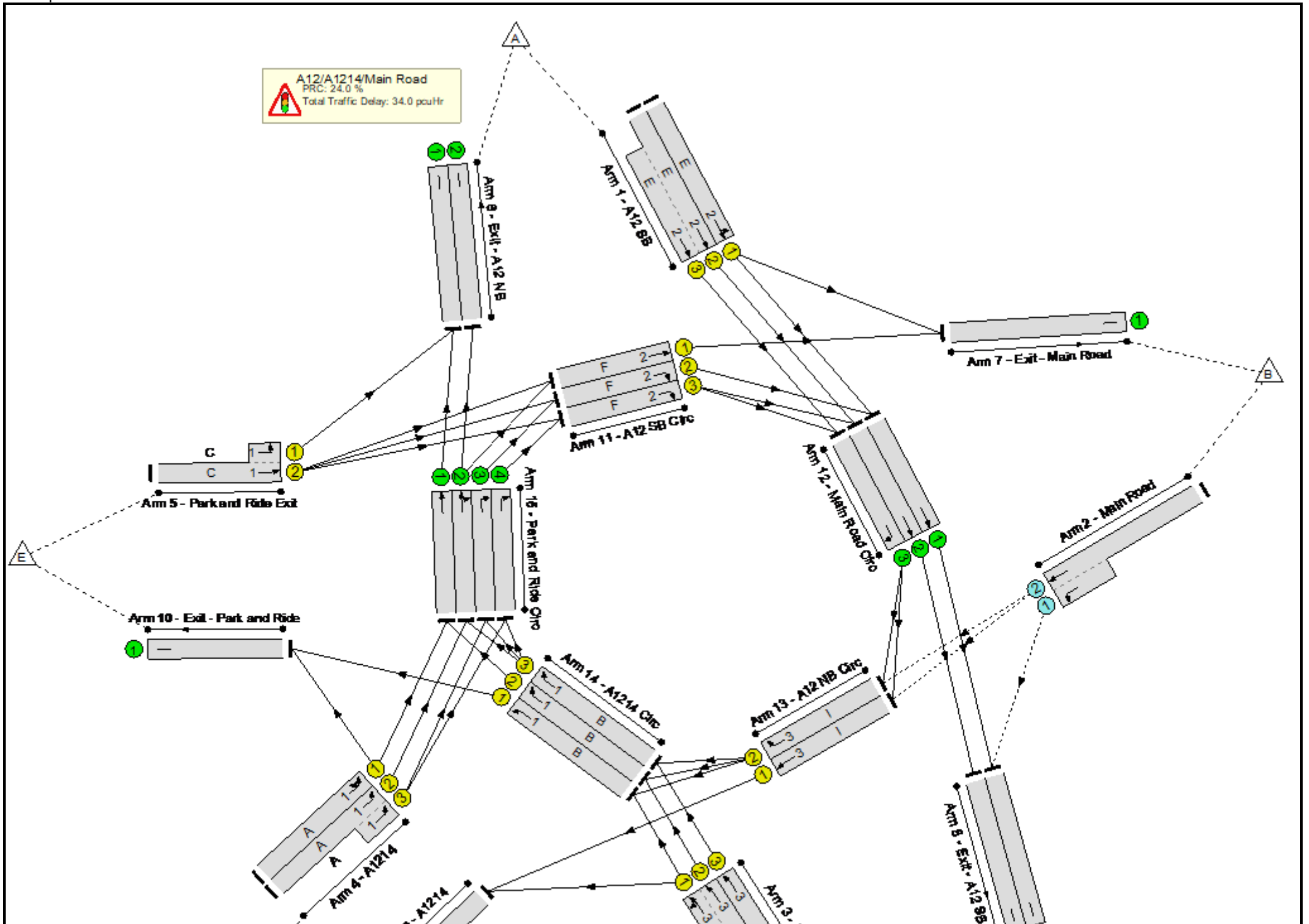

Full Input Data And Results

Full Input Data And Results

Network Results

Item	Lane Description	Lane Type	Controller Stream	Position In Filtered Route	Full Phase	Arrow Phase	Num Greens	Total Green (s)	Arrow Green (s)	Demand Flow (pcu)	Sat Flow (pcu/Hr)	Capacity (pcu)	Deg Sat (%)
Network	-	-	N/A	-	-		-	-	-	-	-	-	72.6%
A12/A1214/Main Road	-	-	N/A	-	-		-	-	-	-	-	-	72.6%
1/1	A12 SB Left Ahead	U	2	N/A	E		1	24	-	454	1955	698	65.0%
1/2+1/3	A12 SB Ahead	U	2	N/A	E		1	24	-	776	2105:1975	1069	72.6%
2/2+2/1	Main Road Left Ahead	O	N/A	N/A	-		-	-	-	184	2015:2015	833	22.1%
3/2+3/1	A12 NB Left Ahead	U	3	N/A	H		1	31	-	971	2115:1995	1479	65.7%
3/3	A12 NB Ahead	U	3	N/A	H		1	31	-	554	1985	907	61.1%
4/1	A1214 U-Turn Left	U	1	N/A	A		1	33	-	187	2025	984	19.0%
4/2+4/3	A1214 Left	U	1	N/A	A		1	33	-	474	2165:2035	1063	44.6%
5/2+5/1	Park and Ride Exit Left Ahead	U	1	N/A	C		0	0	-	0	2015:2025	0	0.0%
6/1	Exit - A12 NB	U	N/A	N/A	-		-	-	-	790	Inf	Inf	0.0%
6/2	Exit - A12 NB	U	N/A	N/A	-		-	-	-	515	Inf	Inf	0.0%
7/1	Exit - Main Road	U	N/A	N/A	-		-	-	-	173	Inf	Inf	0.0%
8/1	Exit - A12 SB	U	N/A	N/A	-		-	-	-	756	Inf	Inf	0.0%
8/2	Exit - A12 SB	U	N/A	N/A	-		-	-	-	710	Inf	Inf	0.0%
9/1	Exit - A1214	U	N/A	N/A	-		-	-	-	644	Inf	Inf	0.0%
10/1	Exit - Park and Ride	U	N/A	N/A	-		-	-	-	12	Inf	Inf	0.0%
11/1	A12 SB Circ Ahead	U	2	N/A	F		1	36	-	163	2105	1113	14.6%
11/2	A12 SB Circ Right	U	2	N/A	F		1	36	-	191	2245	1187	16.1%
11/3	A12 SB Circ Right	U	2	N/A	F		1	36	-	175	2085	1102	15.9%

Full Input Data And Results

12/1	Main Road Circ Ahead	U	N/A	N/A	-		-	-	-	635	2055	2055	30.9%
12/2	Main Road Circ Ahead	U	N/A	N/A	-		-	-	-	710	2055	2055	34.5%
12/3	Main Road Circ Right	U	N/A	N/A	-		-	-	-	241	1995	1995	12.1%
13/1	A12 NB Circ Ahead	U	3	N/A	I		1	29	-	262	2055	881	29.7%
13/2	A12 NB Circ Right	U	3	N/A	I		1	29	-	42	2055	881	4.8%
14/1	A1214 Circ Ahead	U	1	N/A	B		1	27	-	8	2075	830	1.0%
14/2	A1214 Circ Right	U	1	N/A	B		1	27	-	607	2195	878	69.1%
14/3	A1214 Circ Right	U	1	N/A	B		1	27	-	570	2055	822	69.3%
15/1	Park and Ride Circ Ahead	U	N/A	N/A	-		-	-	-	790	2105	2105	37.5%
15/2	Park and Ride Circ Ahead Right	U	N/A	N/A	-		-	-	-	678	2245	2245	30.2%
15/3	Park and Ride Circ Right	U	N/A	N/A	-		-	-	-	191	2245	2245	8.5%
15/4	Park and Ride Circ Right	U	N/A	N/A	-		-	-	-	175	2105	2105	8.3%

Full Input Data And Results

Item	Arriving (pcu)	Leaving (pcu)	Turners In Gaps (pcu)	Turners When Unopposed (pcu)	Turners In Intergreen (pcu)	Uniform Delay (pcuHr)	Rand + Oversat Delay (pcuHr)	Storage Area Uniform Delay (pcuHr)	Total Delay (pcuHr)	Av. Delay Per PCU (s/pcu)	Max. Back of Uniform Queue (pcu)	Rand + Oversat Queue (pcu)	Mean Max Queue (pcu)
Network	-	-	368	0	0	25.4	8.5	0.0	34.0	-	-	-	-
A12/A1214/Main Road	-	-	368	0	0	25.4	8.5	0.0	34.0	-	-	-	-
1/1	454	454	-	-	-	2.4	0.9	-	3.3	26.2	7.3	0.9	8.2
1/2+1/3	776	776	-	-	-	4.0	1.3	-	5.3	24.6	8.9	1.3	10.2
2/2+2/1	184	184	368	0	0	0.1	0.1	-	0.2	4.8	0.5	0.1	0.6
3/2+3/1	971	971	-	-	-	3.7	1.0	-	4.6	17.2	8.4	1.0	9.4
3/3	554	554	-	-	-	2.2	0.8	-	3.0	19.4	8.0	0.8	8.8
4/1	187	187	-	-	-	0.5	0.1	-	0.6	12.5	2.0	0.1	2.1
4/2+4/3	474	474	-	-	-	1.5	0.4	-	1.9	14.1	4.8	0.4	5.3
5/2+5/1	0	0	-	-	-	0.0	0.0	-	0.0	0.0	0.0	0.0	0.0
6/1	790	790	-	-	-	0.0	0.0	-	0.0	0.0	0.0	0.0	0.0
6/2	515	515	-	-	-	0.0	0.0	-	0.0	0.0	0.0	0.0	0.0
7/1	173	173	-	-	-	0.0	0.0	-	0.0	0.0	0.0	0.0	0.0
8/1	756	756	-	-	-	0.0	0.0	-	0.0	0.0	0.0	0.0	0.0
8/2	710	710	-	-	-	0.0	0.0	-	0.0	0.0	0.0	0.0	0.0
9/1	644	644	-	-	-	0.0	0.0	-	0.0	0.0	0.0	0.0	0.0
10/1	12	12	-	-	-	0.0	0.0	-	0.0	0.0	0.0	0.0	0.0
11/1	163	163	-	-	-	0.7	0.1	-	0.8	17.5	2.5	0.1	2.5
11/2	191	191	-	-	-	0.0	0.1	-	0.1	2.6	0.1	0.1	0.2
11/3	175	175	-	-	-	0.0	0.1	-	0.1	2.7	0.1	0.1	0.2
12/1	635	635	-	-	-	0.0	0.2	-	0.2	1.3	0.0	0.2	0.2
12/2	710	710	-	-	-	0.0	0.3	-	0.3	1.4	4.1	0.3	4.3
12/3	241	241	-	-	-	0.0	0.1	-	0.1	1.0	0.0	0.1	0.1
13/1	262	262	-	-	-	0.5	0.2	-	0.7	10.1	1.2	0.2	1.4
13/2	42	42	-	-	-	0.2	0.0	-	0.2	17.6	0.6	0.0	0.6
14/1	8	8	-	-	-	0.0	0.0	-	0.0	16.2	0.1	0.0	0.1

Full Input Data And Results

14/2	607	607	-	-	-	4.9	1.1	-	6.0	35.6	11.8	1.1	12.9
14/3	570	570	-	-	-	4.6	1.1	-	5.8	36.4	11.1	1.1	12.2
15/1	790	790	-	-	-	0.0	0.3	-	0.3	1.5	9.5	0.3	9.8
15/2	678	678	-	-	-	0.0	0.2	-	0.2	1.1	0.0	0.2	0.2
15/3	191	191	-	-	-	0.0	0.0	-	0.0	0.9	0.0	0.0	0.0
15/4	175	175	-	-	-	0.0	0.0	-	0.0	0.9	0.0	0.0	0.0
			C1	Stream: 1 PRC for Signalled Lanes (%)	29.8	Total Delay for Signalled Lanes (pcuHr):			14.31	Cycle Time (s):		70	
			C1	Stream: 2 PRC for Signalled Lanes (%)	24.0	Total Delay for Signalled Lanes (pcuHr):			9.66	Cycle Time (s):		70	
			C1	Stream: 3 PRC for Signalled Lanes (%)	37.1	Total Delay for Signalled Lanes (pcuHr):			8.57	Cycle Time (s):		70	
				PRC Over All Lanes (%)	24.0	Total Delay Over All Lanes(pcuHr):			33.99				

APPENDIX 06

ARCADY Results (A12/Newbourne Road)

Junctions 9
ARCADY 9 - Roundabout Module
Version: 9.5.1.7462 © Copyright TRL Limited, 2019
For sales and distribution information, program advice and maintenance, contact TRL: +44 (0)1344 379777 software@trl.co.uk www.trlsoftware.co.uk
The users of this computer program for the solution of an engineering problem are in no way relieved of their responsibility for the correctness of the solution

Filename: 20220120_A12_Foxhall_Road_2016_base_Updated HGV.j9
Path: \\euafs\SHEFS\SHE\AMA Sheffield\Projects\Scottish Power Renewables - 00481\404.05356.00006 - East Anglia offshore wind farms\EA3\A12 Corridor TAs\A12_Foxhall Road Roundabout
Report generation date: 20/01/2022 13:16:33

- «2024 Base + Com Dev, PM
 - »Junction Network
 - »Arms
 - »Traffic Demand
 - »Origin-Destination Data
 - »Vehicle Mix
 - »Results

Summary of junction performance

PM					
	Set ID	Queue (PCU)	Delay (s)	RFC	LOS
2024 Base + Com Dev					
Arm 1	D1	215.8	393.48	1.21	F
Arm 2		8.3	91.10	0.94	F
Arm 3		246.7	425.48	1.22	F
Arm 4		6.2	60.29	0.88	F
2024 Base + Com Dev + EA3					
Arm 1	D2	224.0	411.12	1.21	F
Arm 2		12.6	126.69	0.99	F
Arm 3		253.3	441.66	1.23	F
Arm 4		6.5	63.22	0.89	F

Values shown are the highest values encountered over all time segments. Delay is the maximum value of average delay per arriving vehicle.

File summary

File Description

Title	A12/ Foxhall Road Roundabout
Location	Ipswich
Site number	
Date	13/01/2022
Version	1
Status	(new file)
Identifier	
Client	SPR
Jobnumber	404.05356.00006
Enumerator	SLR\llong
Description	

Units

Distance units	Speed units	Traffic units input	Traffic units results	Flow units	Average delay units	Total delay units	Rate of delay units
m	kph	PCU	PCU	perHour	s	-Min	perMin

Analysis Options

Calculate Queue Percentiles	Calculate residual capacity	RFC Threshold	Average Delay threshold (s)	Queue threshold (PCU)
		0.85	36.00	20.00

Analysis Set Details

ID	Network flow scaling factor (%)
A1	100.000

Demand Set Details

ID	Scenario name	Time Period name	Traffic profile type	Start time (HH:mm)	Finish time (HH:mm)	Time segment length (min)
D1	2024 Base + Com Dev	PM	ONE HOUR	16:45	18:15	15

2024 Base + Com Dev, PM

Data Errors and Warnings

No errors or warnings

Junction Network

Junctions

Junction	Name	Junction type	Use circulating lanes	Arm order	Junction Delay (s)	Junction LOS
1	A12/ Foxhall Road	Standard Roundabout		1, 2, 3, 4	365.26	F

Junction Network Options

Driving side	Lighting
Left	Normal/unknown

Arms

Arms

Arm	Name	Description
1	A12 N	
2	Newbourne Road	
3	A12 S	
4	Foxhall Road	

Roundabout Geometry

Arm	V - Approach road half-width (m)	E - Entry width (m)	I' - Effective flare length (m)	R - Entry radius (m)	D - Inscribed circle diameter (m)	PHI - Conflict (entry) angle (deg)	Exit only
1	6.09	7.72	1.0	43.3	72.9	16.0	
2	3.93	3.93	9.4	25.1	72.9	30.0	
3	7.72	7.86	3.0	23.5	72.9	23.0	
4	3.57	4.12	16.2	27.5	72.9	19.0	

Slope / Intercept / Capacity

Roundabout Slope and Intercept used in model

Arm	Final slope	Final intercept (PCU/hr)
1	0.568	2069
2	0.420	1202
3	0.617	2452
4	0.443	1295

The slope and intercept shown above include any corrections and adjustments.

Traffic Demand

Vehicle mix source	PCU Factor for a HV (PCU)
HV Percentages	2.00

Demand overview (Traffic)

Arm	Linked arm	Use O-D data	Average Demand (PCU/hr)	Scaling Factor (%)
1		✓	2112	100.000
2		✓	320	100.000
3		✓	2290	100.000
4		✓	360	100.000

Origin-Destination Data

Demand (PCU/hr)

	To				
	1	2	3	4	
From	1	0	109	1555	448
	2	132	0	117	71
	3	1874	86	0	330
	4	205	28	127	0

Vehicle Mix

Heavy Vehicle Percentages

	To				
	1	2	3	4	
From	1	0	3	4	4
	2	1	0	2	2
	3	3	2	0	5
	4	2	3	3	0

Results

Results Summary for whole modelled period

Arm	Max RFC	Max Delay (s)	Max Queue (PCU)	Max LOS
1	1.21	393.48	215.8	F
2	0.94	91.10	8.3	F
3	1.22	425.48	246.7	F
4	0.88	60.29	6.2	F

Main Results for each time segment

16:45 - 17:00

Arm	Total Demand (PCU/hr)	Circulating flow (PCU/hr)	Capacity (PCU/hr)	RFC	Throughput (PCU/hr)	End queue (PCU)	Delay (s)	Unsignalised level of service
1	1590	179	1967	0.808	1573	4.1	9.124	A
2	241	1587	536	0.449	238	0.8	12.118	B
3	1724	485	2153	0.801	1708	4.0	8.097	A
4	271	1560	603	0.450	268	0.8	10.897	B

17:00 - 17:15

Arm	Total Demand (PCU/hr)	Circulating flow (PCU/hr)	Capacity (PCU/hr)	RFC	Throughput (PCU/hr)	End queue (PCU)	Delay (s)	Unsignalised level of service
1	1899	213	1948	0.975	1848	16.8	28.446	D
2	288	1865	419	0.686	283	2.0	25.878	D
3	2059	571	2099	0.981	2001	18.4	28.156	D
4	324	1829	483	0.669	319	1.9	21.864	C

17:15 - 17:30

Arm	Total Demand (PCU/hr)	Circulating flow (PCU/hr)	Capacity (PCU/hr)	RFC	Throughput (PCU/hr)	End queue (PCU)	Delay (s)	Unsignalised level of service
1	2325	242	1931	1.204	1927	116.5	131.743	F
2	352	1962	379	0.930	334	6.6	64.677	F
3	2521	621	2069	1.219	2065	132.4	138.118	F
4	396	1906	450	0.882	383	5.3	47.722	E

17:30 - 17:45

Arm	Total Demand (PCU/hr)	Circulating flow (PCU/hr)	Capacity (PCU/hr)	RFC	Throughput (PCU/hr)	End queue (PCU)	Delay (s)	Unsignalised level of service
1	2325	247	1928	1.206	1928	215.8	314.206	F
2	352	1967	377	0.935	345	8.3	91.104	F
3	2521	628	2065	1.221	2064	246.7	334.097	F
4	396	1909	448	0.885	393	6.2	60.286	F

17:45 - 18:00

Arm	Total Demand (PCU/hr)	Circulating flow (PCU/hr)	Capacity (PCU/hr)	RFC	Throughput (PCU/hr)	End queue (PCU)	Delay (s)	Unsignalised level of service
1	1899	223	1942	0.978	1933	207.3	393.480	F
2	288	1952	383	0.751	307	3.5	54.459	F
3	2059	605	2079	0.990	2070	243.8	425.483	F
4	324	1899	453	0.715	337	2.8	34.612	D

18:00 - 18:15

Arm	Total Demand (PCU/hr)	Circulating flow (PCU/hr)	Capacity (PCU/hr)	RFC	Throughput (PCU/hr)	End queue (PCU)	Delay (s)	Unsignalised level of service
1	1590	197	1956	0.813	1947	118.1	301.845	F
2	241	1944	387	0.623	248	1.8	27.509	D
3	1724	570	2100	0.821	2091	152.0	341.423	F
4	271	1892	456	0.595	276	1.6	21.057	C

APPENDIX 07

Crashmap Reports



Validated Data

Crash Date: Saturday, March 07, 2015 **Time of Crash:** 3:13:00 PM **Crash Reference:** 201537EA88591

Highest Injury Severity:	Serious	Road Number:	A12	Number of Casualties:	1
Highway Authority:	Suffolk	Number of Vehicles:	1	OS Grid Reference:	624136 246303
Local Authority:	Suffolk Coastal District				
Weather Description:	Fine without high winds				
Road Surface Description:	Dry				
Speed Limit:	50				
Light Conditions:	Daylight: regardless of presence of streetlights				
Carriageway Hazards:	None				
Junction Detail:	Roundabout				
Junction Pedestrian Crossing:	No physical crossing facility within 50 metres				
Road Type:	Roundabout				
Junction Control:	Auto traffic signal				

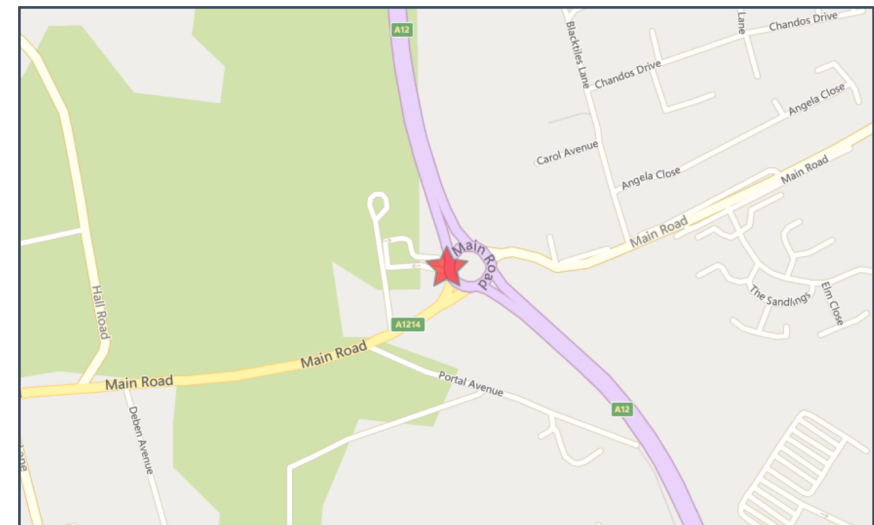

For more information about the data please visit: www.crashmap.co.uk/home/Faq
To subscribe to unlimited reports using CrashMap Pro visit www.crashmap.co.uk/Home/Premium_Services



Validated Data

Vehicles involved

Vehicle Ref	Vehicle Type	Vehicle Age	Driver Gender	Driver Age Band	Vehicle Manoeuvre	First Point of Impact	Journey Purpose	Hit Object - On Carriageway	Hit Object - Off Carriageway
1	Motorcycle over 500cc	14	Male	21 - 25	Vehicle proceeding normally along the carriageway, not on a bend	Did not impact	Other	None	None

Casualties

Vehicle Ref	Casualty Ref	Injury Severity	Casualty Class	Gender	Age Band	Pedestrian Location	Pedestrian Movement
1	1	Serious	Driver or rider	Male	21 - 25	Unknown or other	Unknown or other

For more information about the data please visit: www.crashmap.co.uk/home/Faq

To subscribe to unlimited reports using CrashMap Pro visit www.crashmap.co.uk/Home/Premium_Services



Validated Data

Crash Date:	Wednesday, November 16, 2016	Time of Crash:	9:33:00 AM	Crash Reference:	2016370133654
Highest Injury Severity:	Serious	Road Number:	A12	Number of Casualties:	1
Highway Authority:	Suffolk			Number of Vehicles:	2
Local Authority:	Suffolk Coastal District			OS Grid Reference:	624235 246324
Weather Description:	Fine without high winds				
Road Surface Description:	Wet or Damp				
Speed Limit:	60				
Light Conditions:	Daylight: regardless of presence of streetlights				
Carriageway Hazards:	None				
Junction Detail:	T or staggered junction				
Junction Pedestrian Crossing:	No physical crossing facility within 50 metres				
Road Type:	Roundabout				
Junction Control:	Give way or uncontrolled				

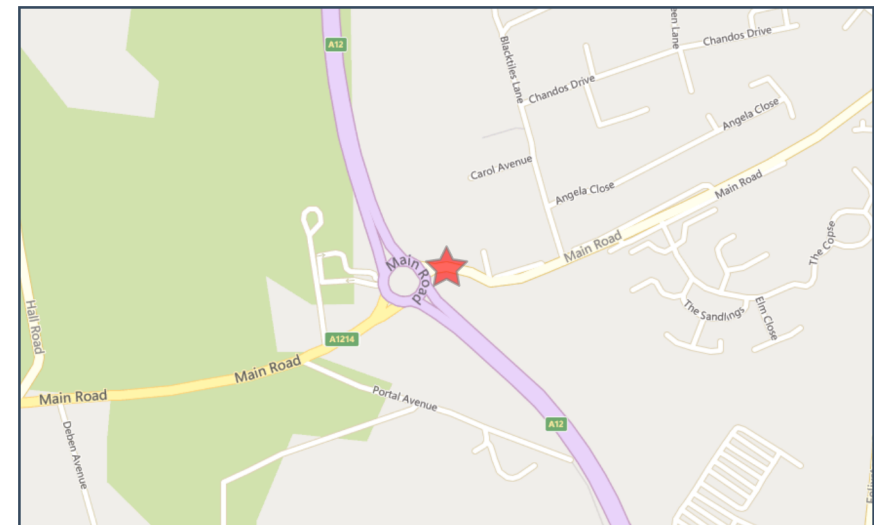

For more information about the data please visit: www.crashmap.co.uk/home/Faq
To subscribe to unlimited reports using CrashMap Pro visit www.crashmap.co.uk/Home/Premium_Services



Validated Data

Vehicles involved

Vehicle Ref	Vehicle Type	Vehicle Age	Driver Gender	Driver Age Band	Vehicle Maneouvre	First Point of Impact	Journey Purpose	Hit Object - On Carriageway	Hit Object - Off Carriageway
1	Car (excluding private hire)	10	Female	36 - 45	Vehicle proceeding normally along the carriageway, not on a bend	Offside	Other	None	None
2	Car (excluding private hire)	-1	Female	36 - 45	Vehicle proceeding normally along the carriageway, not on a bend	Nearside	Other	None	None

Casualties

Vehicle Ref	Casualty Ref	Injury Severity	Casualty Class	Gender	Age Band	Pedestrian Location	Pedestrian Movement
1	1	Serious	Vehicle or pillion passenger	Male	Over 75	Unknown or other	Unknown or other

For more information about the data please visit: www.crashmap.co.uk/home/Faq

To subscribe to unlimited reports using CrashMap Pro visit www.crashmap.co.uk/Home/Premium_Services



Validated Data

Crash Date: Monday, May 04, 2015 **Time of Crash:** 12:05:00 PM **Crash Reference:** 201537EA90007

Highest Injury Severity:	Slight	Road Number:	A12	Number of Casualties:	1
Highway Authority:	Suffolk			Number of Vehicles:	2
Local Authority:	Suffolk Coastal District			OS Grid Reference:	626029 249352
Weather Description:	Unknown				
Road Surface Description:	Dry				
Speed Limit:	40				
Light Conditions:	Daylight: regardless of presence of streetlights				
Carriageway Hazards:	None				
Junction Detail:	Roundabout				
Junction Pedestrian Crossing:	No physical crossing facility within 50 metres				
Road Type:	Roundabout				
Junction Control:	Give way or uncontrolled				

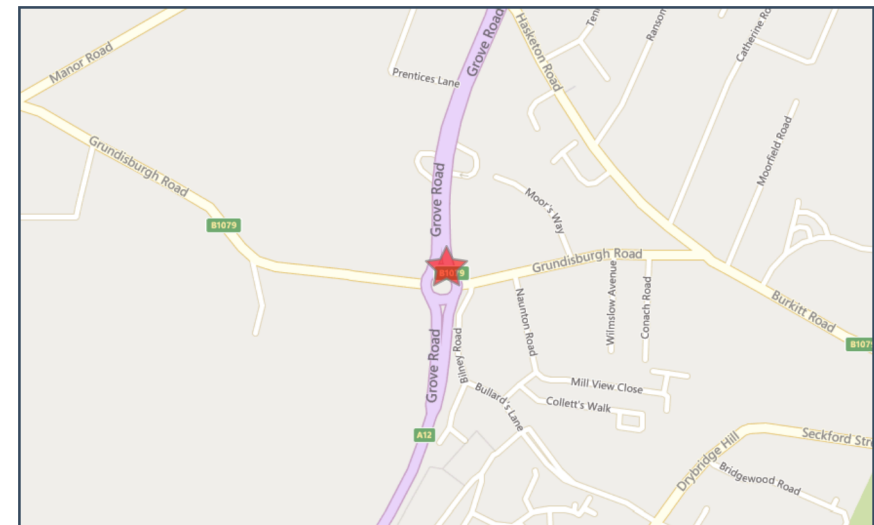

For more information about the data please visit: www.crashmap.co.uk/home/Faq
To subscribe to unlimited reports using CrashMap Pro visit www.crashmap.co.uk/Home/Premium_Services



Validated Data

Vehicles involved

Vehicle Ref	Vehicle Type	Vehicle Age	Driver Gender	Driver Age Band	Vehicle Maneouvre	First Point of Impact	Journey Purpose	Hit Object - On Carriageway	Hit Object - Off Carriageway
1	Car (excluding private hire)	35	Unknown	Unknown	Vehicle proceeding normally along the carriageway, not on a bend	Front	Other	None	None
2	Car (excluding private hire)	11	Female	56 - 65	Vehicle is waiting to proceed normally but is held up	Back	Other	None	None

Casualties

Vehicle Ref	Casualty Ref	Injury Severity	Casualty Class	Gender	Age Band	Pedestrian Location	Pedestrian Movement
2	1	Slight	Driver or rider	Female	56 - 65	Unknown or other	Unknown or other

For more information about the data please visit: www.crashmap.co.uk/home/Faq

To subscribe to unlimited reports using CrashMap Pro visit www.crashmap.co.uk/Home/Premium_Services



Validated Data

Crash Date: Saturday, September 19, 2015 **Time of Crash:** 7:55:00 AM **Crash Reference:** 201537EA93865

Highest Injury Severity:	Slight	Road Number:	A12	Number of Casualties:	1
Highway Authority:	Suffolk			Number of Vehicles:	2
Local Authority:	Suffolk Coastal District			OS Grid Reference:	626032 249346
Weather Description:	Fine without high winds				
Road Surface Description:	Wet or Damp				
Speed Limit:	40				
Light Conditions:	Daylight: regardless of presence of streetlights				
Carriageway Hazards:	None				
Junction Detail:	Roundabout				
Junction Pedestrian Crossing:	No physical crossing facility within 50 metres				
Road Type:	Roundabout				
Junction Control:	Give way or uncontrolled				

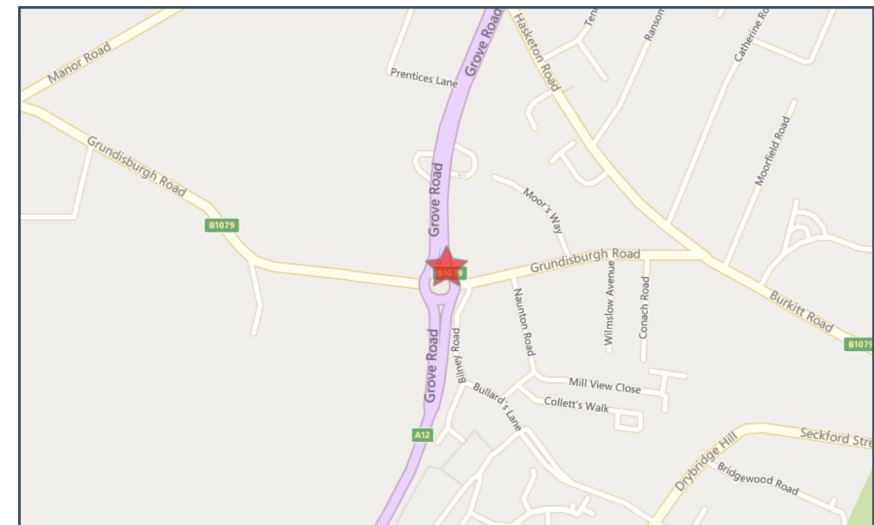

For more information about the data please visit: www.crashmap.co.uk/home/Faq
To subscribe to unlimited reports using CrashMap Pro visit www.crashmap.co.uk/Home/Premium_Services



Validated Data

Vehicles involved

Vehicle Ref	Vehicle Type	Vehicle Age	Driver Gender	Driver Age Band	Vehicle Manoeuvre	First Point of Impact	Journey Purpose	Hit Object - On Carriageway	Hit Object - Off Carriageway
1	Car (excluding private hire)		4 Female	16 - 20	Vehicle proceeding normally along the carriageway, not on a bend	Front	Other	None	None
2	Pedal cycle		-1 Male	26 - 35	Vehicle proceeding normally along the carriageway, not on a bend	Front	Other	None	None

Casualties

Vehicle Ref	Casualty Ref	Injury Severity	Casualty Class	Gender	Age Band	Pedestrian Location	Pedestrian Movement
	2	1 Slight	Driver or rider	Male	26 - 35	Unknown or other	Unknown or other

For more information about the data please visit: www.crashmap.co.uk/home/Faq

To subscribe to unlimited reports using CrashMap Pro visit www.crashmap.co.uk/Home/Premium_Services



Validated Data

Crash Date: Monday, November 30, 2015 **Time of Crash:** 1:20:00 PM **Crash Reference:** 201537EA95849

Highest Injury Severity:	Slight	Road Number:	A12	Number of Casualties:	1
Highway Authority:	Suffolk	Number of Vehicles:	2	OS Grid Reference:	626033 249352
Local Authority:	Suffolk Coastal District				
Weather Description:	Raining with high winds				
Road Surface Description:	Wet or Damp				
Speed Limit:	40				
Light Conditions:	Daylight: regardless of presence of streetlights				
Carriageway Hazards:	None				
Junction Detail:	Roundabout				
Junction Pedestrian Crossing:	No physical crossing facility within 50 metres				
Road Type:	Roundabout				
Junction Control:	Give way or uncontrolled				

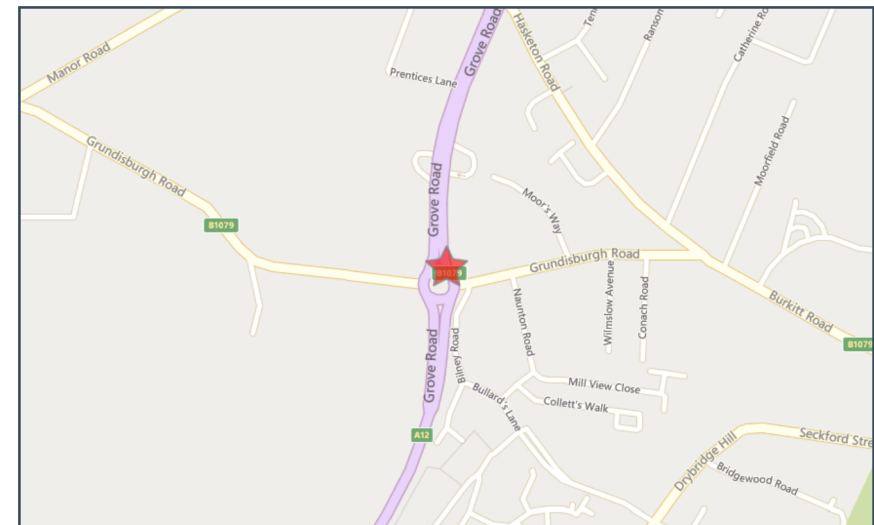

For more information about the data please visit: www.crashmap.co.uk/home/Faq
To subscribe to unlimited reports using CrashMap Pro visit www.crashmap.co.uk/Home/Premium_Services



Validated Data

Vehicles involved

Vehicle Ref	Vehicle Type	Vehicle Age	Driver Gender	Driver Age Band	Vehicle Maneouvre	First Point of Impact	Journey Purpose	Hit Object - On Carriageway	Hit Object - Off Carriageway
1	Van or goods vehicle 3.5 tonnes mgw and under		1 Male	56 - 65	Vehicle is slowing down or stopping	Front	Journey as part of work	None	None
2	Car (excluding private hire)		6 Female	21 - 25	Vehicle is waiting to proceed normally but is held up	Back	Commuting to/from work	None	None

Casualties

Vehicle Ref	Casualty Ref	Injury Severity	Casualty Class	Gender	Age Band	Pedestrian Location	Pedestrian Movement
	2	1 Slight	Driver or rider	Female	21 - 25	Unknown or other	Unknown or other

For more information about the data please visit: www.crashmap.co.uk/home/Faq

To subscribe to unlimited reports using CrashMap Pro visit www.crashmap.co.uk/Home/Premium_Services



Validated Data

Crash Date: Wednesday, March 27, 2019 **Time of Crash:** 7:27:00 AM **Crash Reference:** 2019370829505

Highest Injury Severity:	Slight	Road Number:	A12	Number of Casualties:	1
Highway Authority:	Suffolk	Number of Vehicles:	5	OS Grid Reference:	626009 249292
Local Authority:	Suffolk Coastal District				
Weather Description:	Fine without high winds				
Road Surface Description:	Dry				
Speed Limit:	60				
Light Conditions:	Daylight: regardless of presence of streetlights				
Carriageway Hazards:	None				
Junction Detail:	Roundabout				
Junction Pedestrian Crossing:	No physical crossing facility within 50 metres				
Road Type:	Dual carriageway				
Junction Control:	Give way or uncontrolled				

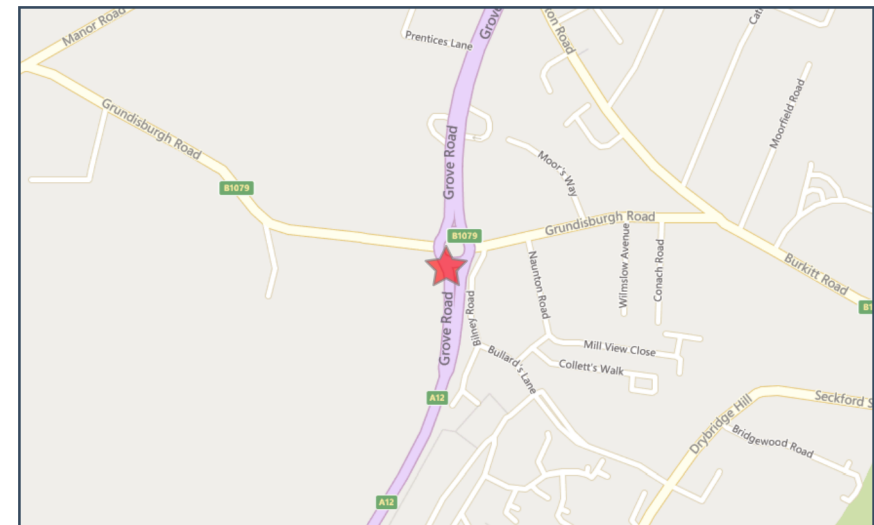

For more information about the data please visit: www.crashmap.co.uk/home/Faq
To subscribe to unlimited reports using CrashMap Pro visit www.crashmap.co.uk/Home/Premium_Services



Validated Data

Vehicles involved

Vehicle Ref	Vehicle Type	Vehicle Age	Driver Gender	Driver Age Band	Vehicle Maneouvre	First Point of Impact	Journey Purpose	Hit Object - On Carriageway	Hit Object - Off Carriageway
1	Car (excluding private hire)	18	Male	21 - 25	Vehicle proceeding normally along the carriageway, not on a bend	Front	Other	None	None
2	Car (excluding private hire)	9	Male	36 - 45	Vehicle is waiting to proceed normally but is held up	Offside	Journey as part of work	None	None
3	Car (excluding private hire)	6	Male	46 - 55	Vehicle is waiting to proceed normally but is held up	Nearside	Commuting to/from work	None	None
4	Car (excluding private hire)	2	Male	Unknown	Vehicle proceeding normally along the carriageway, not on a bend	Front	Journey as part of work	None	None
5	Car (excluding private hire)	3	Male	Unknown	Vehicle proceeding normally along the carriageway, not on a bend	Front	Journey as part of work	None	None

Casualties

Vehicle Ref	Casualty Ref	Injury Severity	Casualty Class	Gender	Age Band	Pedestrian Location	Pedestrian Movement
2	1	Slight	Driver or rider	Male	36 - 45	Unknown or other	Unknown or other

For more information about the data please visit: www.crashmap.co.uk/home/Faq

To subscribe to unlimited reports using CrashMap Pro visit www.crashmap.co.uk/Home/Premium_Services



Validated Data

Crash Date: Wednesday, August 21, 2019 **Time of Crash:** 9:30:00 PM **Crash Reference:** 2019370872259

Highest Injury Severity:	Serious	Road Number:	A12	Number of Casualties:	1
Highway Authority:	Suffolk	Number of Vehicles:	2	OS Grid Reference:	626008 249297
Local Authority:	Suffolk Coastal District				
Weather Description:	Fine without high winds				
Road Surface Description:	Dry				
Speed Limit:	40				
Light Conditions:	Darkness: street lights present and lit				
Carriageway Hazards:	None				
Junction Detail:	Roundabout				
Junction Pedestrian Crossing:	No physical crossing facility within 50 metres				
Road Type:	Roundabout				
Junction Control:	Give way or uncontrolled				

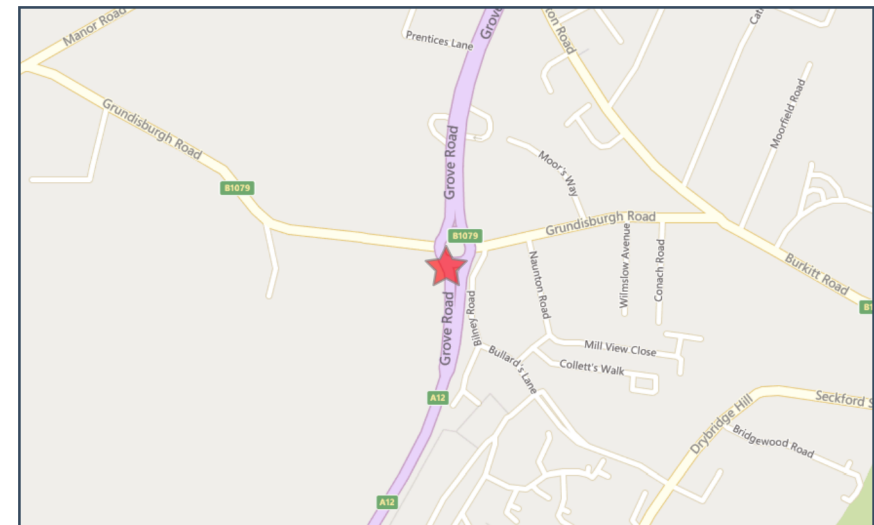

For more information about the data please visit: www.crashmap.co.uk/home/Faq
To subscribe to unlimited reports using CrashMap Pro visit www.crashmap.co.uk/Home/Premium_Services



Validated Data

Vehicles involved

Vehicle Ref	Vehicle Type	Vehicle Age	Driver Gender	Driver Age Band	Vehicle Maneouvre	First Point of Impact	Journey Purpose	Hit Object - On Carriageway	Hit Object - Off Carriageway
1	Motorcycle over 50cc and up to 125cc	9	Male	26 - 35	Vehicle proceeding normally along the carriageway, not on a bend	Front	Other	None	None
2	Car (excluding private hire)	11	Male	46 - 55	Vehicle is slowing down or stopping	Back	Other	None	None

Casualties

Vehicle Ref	Casualty Ref	Injury Severity	Casualty Class	Gender	Age Band	Pedestrian Location	Pedestrian Movement
1	1	Serious	Driver or rider	Male	26 - 35	Unknown or other	Unknown or other

For more information about the data please visit: www.crashmap.co.uk/home/Faq

To subscribe to unlimited reports using CrashMap Pro visit www.crashmap.co.uk/Home/Premium_Services



Validated Data

Crash Date: Thursday, October 06, 2016 **Time of Crash:** 4:40:00 PM **Crash Reference:** 2016370120558

Highest Injury Severity:	Slight	Road Number:	A12	Number of Casualties:	1
Highway Authority:	Suffolk			Number of Vehicles:	2
Local Authority:	Suffolk Coastal District			OS Grid Reference:	626018 249323
Weather Description:	Fine without high winds				
Road Surface Description:	Dry				
Speed Limit:	40				
Light Conditions:	Daylight: regardless of presence of streetlights				
Carriageway Hazards:	None				
Junction Detail:	Roundabout				
Junction Pedestrian Crossing:	No physical crossing facility within 50 metres				
Road Type:	Roundabout				
Junction Control:	Give way or uncontrolled				

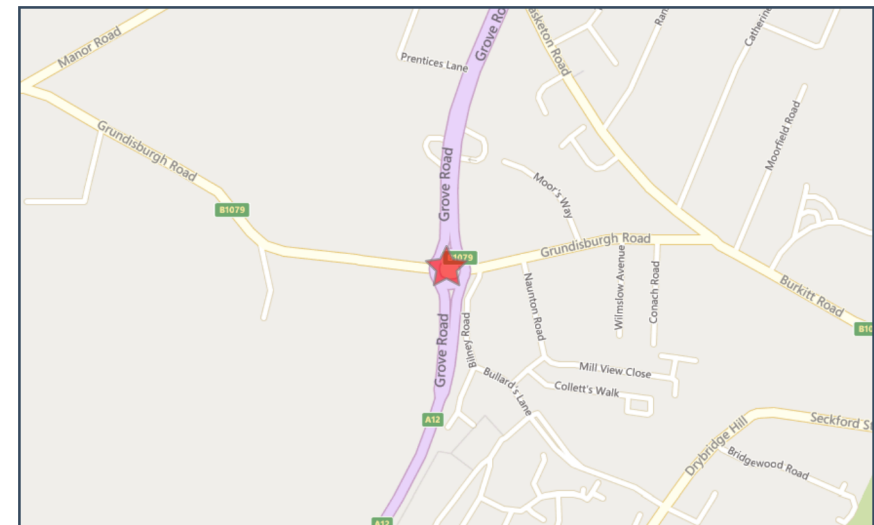

For more information about the data please visit: www.crashmap.co.uk/home/Faq
To subscribe to unlimited reports using CrashMap Pro visit www.crashmap.co.uk/Home/Premium_Services



Validated Data

Vehicles involved

Vehicle Ref	Vehicle Type	Vehicle Age	Driver Gender	Driver Age Band	Vehicle Maneouvre	First Point of Impact	Journey Purpose	Hit Object - On Carriageway	Hit Object - Off Carriageway
1	Car (excluding private hire)		3 Male	56 - 65	Vehicle is moving off	Offside	Other	None	None
2	Pedal cycle		-1 Female	Unknown	Vehicle is in the act of turning right	Did not impact	Other	None	None

Casualties

Vehicle Ref	Casualty Ref	Injury Severity	Casualty Class	Gender	Age Band	Pedestrian Location	Pedestrian Movement
2	1	Slight	Driver or rider	Female	Unknown	Unknown or other	Unknown or other

For more information about the data please visit: www.crashmap.co.uk/home/Faq

To subscribe to unlimited reports using CrashMap Pro visit www.crashmap.co.uk/Home/Premium_Services



Validated Data

Crash Date: Saturday, November 07, 2015 **Time of Crash:** 12:50:00 PM **Crash Reference:** 201537EA95212

Highest Injury Severity:	Slight	Road Number:	A12	Number of Casualties:	1
Highway Authority:	Suffolk			Number of Vehicles:	2
Local Authority:	Suffolk Coastal District			OS Grid Reference:	625430 248031
Weather Description:	Raining with high winds				
Road Surface Description:	Wet or Damp				
Speed Limit:	60				
Light Conditions:	Daylight: regardless of presence of streetlights				
Carriageway Hazards:	None				
Junction Detail:	Not at or within 20 metres of junction				
Junction Pedestrian Crossing:	No physical crossing facility within 50 metres				
Road Type:	Dual carriageway				
Junction Control:	Not Applicable				

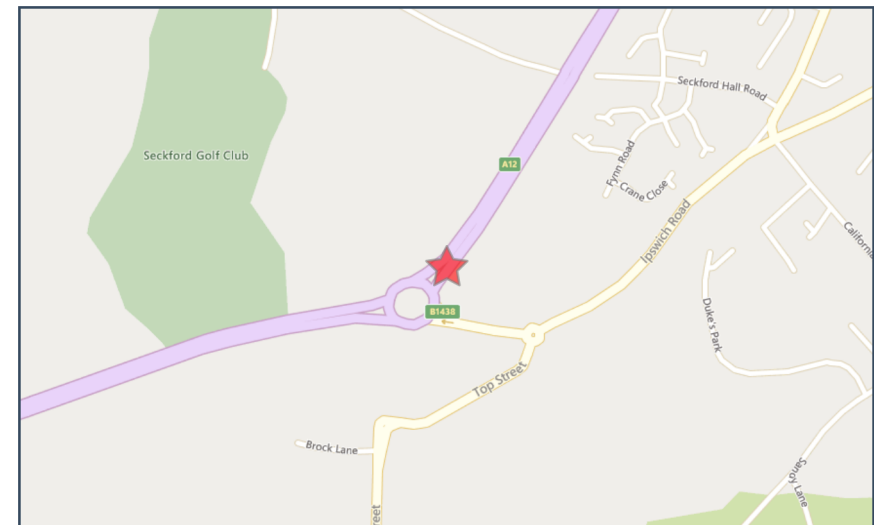

For more information about the data please visit: www.crashmap.co.uk/home/Faq
To subscribe to unlimited reports using CrashMap Pro visit www.crashmap.co.uk/Home/Premium_Services



Validated Data

Vehicles involved

Vehicle Ref	Vehicle Type	Vehicle Age	Driver Gender	Driver Age Band	Vehicle Maneouvre	First Point of Impact	Journey Purpose	Hit Object - On Carriageway	Hit Object - Off Carriageway
1	Car (excluding private hire)	13	Male	36 - 45	Vehicle proceeding normally along the carriageway, not on a bend	Front	Other	None	None
2	Car (excluding private hire)	-1	Male	56 - 65	Vehicle is slowing down or stopping	Back	Other	None	None

Casualties

Vehicle Ref	Casualty Ref	Injury Severity	Casualty Class	Gender	Age Band	Pedestrian Location	Pedestrian Movement
2	1	Slight	Driver or rider	Male	56 - 65	Unknown or other	Unknown or other

For more information about the data please visit: www.crashmap.co.uk/home/Faq

To subscribe to unlimited reports using CrashMap Pro visit www.crashmap.co.uk/Home/Premium_Services



Validated Data

Crash Date: Thursday, February 01, 2018 **Time of Crash:** 6:20:00 PM **Crash Reference:** 2018370265732

Highest Injury Severity:	Serious	Road Number:	A12	Number of Casualties:	1
Highway Authority:	Suffolk			Number of Vehicles:	2
Local Authority:	Suffolk Coastal District			OS Grid Reference:	625420 248015
Weather Description:	Raining without high winds				
Road Surface Description:	Wet or Damp				
Speed Limit:	70				
Light Conditions:	Daylight: regardless of presence of streetlights				
Carriageway Hazards:	None				
Junction Detail:	Not at or within 20 metres of junction				
Junction Pedestrian Crossing:	No physical crossing facility within 50 metres				
Road Type:	Dual carriageway				
Junction Control:	Not Applicable				

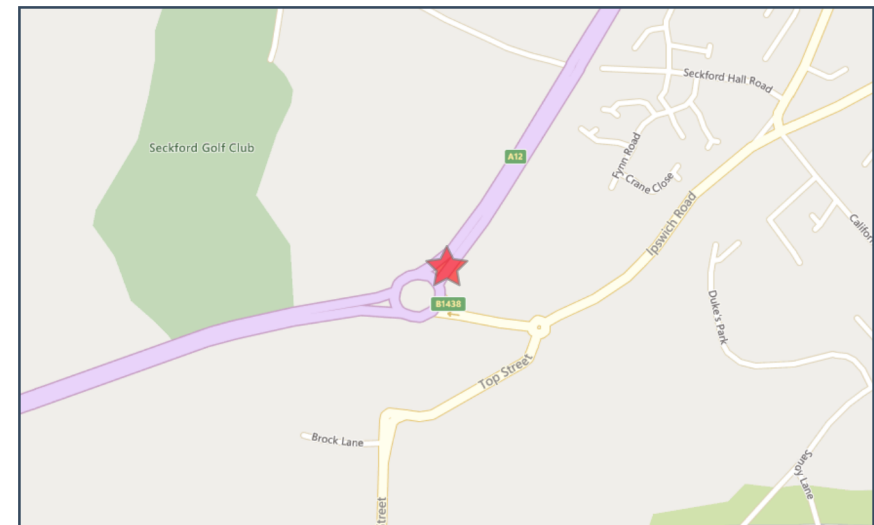

For more information about the data please visit: www.crashmap.co.uk/home/Faq
To subscribe to unlimited reports using CrashMap Pro visit www.crashmap.co.uk/Home/Premium_Services



Validated Data

Vehicles involved

Vehicle Ref	Vehicle Type	Vehicle Age	Driver Gender	Driver Age Band	Vehicle Maneouvre	First Point of Impact	Journey Purpose	Hit Object - On Carriageway	Hit Object - Off Carriageway
1	Car (excluding private hire)	3	Male	46 - 55	Vehicle proceeding normally along the carriageway, not on a bend	Offside	Other	None	None
2	Motorcycle over 500cc	10	Male	56 - 65	Vehicle is in the act of turning right	Front	Other	None	None

Casualties

Vehicle Ref	Casualty Ref	Injury Severity	Casualty Class	Gender	Age Band	Pedestrian Location	Pedestrian Movement
2	1	Serious	Driver or rider	Male	56 - 65	Unknown or other	Unknown or other

For more information about the data please visit: www.crashmap.co.uk/home/Faq

To subscribe to unlimited reports using CrashMap Pro visit www.crashmap.co.uk/Home/Premium_Services



Validated Data

Crash Date: Monday, May 14, 2018 **Time of Crash:** 3:48:00 PM **Crash Reference:** 2018370298289

Highest Injury Severity:	Slight	Road Number:	A12	Number of Casualties:	1
Highway Authority:	Suffolk			Number of Vehicles:	2
Local Authority:	Suffolk Coastal District			OS Grid Reference:	625438 248010
Weather Description:	Fine without high winds				
Road Surface Description:	Dry				
Speed Limit:	70				
Light Conditions:	Daylight: regardless of presence of streetlights				
Carriageway Hazards:	None				
Junction Detail:	Roundabout				
Junction Pedestrian Crossing:	No physical crossing facility within 50 metres				
Road Type:	Dual carriageway				
Junction Control:	Give way or uncontrolled				

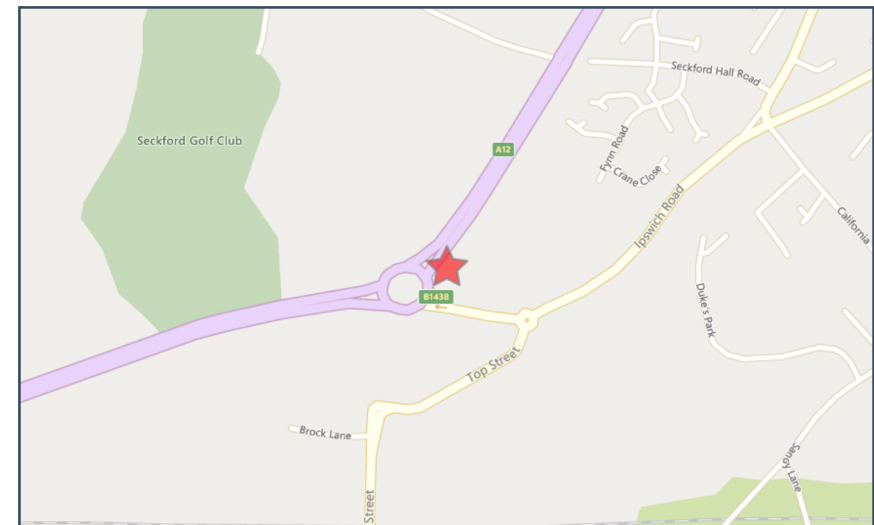

For more information about the data please visit: www.crashmap.co.uk/home/Faq
To subscribe to unlimited reports using CrashMap Pro visit www.crashmap.co.uk/Home/Premium_Services



Validated Data

Vehicles involved

Vehicle Ref	Vehicle Type	Vehicle Age	Driver Gender	Driver Age Band	Vehicle Maneouvre	First Point of Impact	Journey Purpose	Hit Object - On Carriageway	Hit Object - Off Carriageway
1	Motorcycle over 500cc	15	Male	46 - 55	Vehicle proceeding normally along the carriageway, not on a bend	Front	Other	None	None
2	Car (excluding private hire)	3	Female	21 - 25	Vehicle proceeding normally along the carriageway, not on a bend	Back	Other	None	None

Casualties

Vehicle Ref	Casualty Ref	Injury Severity	Casualty Class	Gender	Age Band	Pedestrian Location	Pedestrian Movement
1	1	Slight	Driver or rider	Male	46 - 55	Unknown or other	Unknown or other

For more information about the data please visit: www.crashmap.co.uk/home/Faq

To subscribe to unlimited reports using CrashMap Pro visit www.crashmap.co.uk/Home/Premium_Services



Validated Data

Crash Date: Monday, July 27, 2015 **Time of Crash:** 3:50:00 PM **Crash Reference:** 201537EA92461

Highest Injury Severity:	Slight	Road Number:	A12	Number of Casualties:	1
Highway Authority:	Suffolk			Number of Vehicles:	2
Local Authority:	Suffolk Coastal District			OS Grid Reference:	624631 243931
Weather Description:	Fine without high winds				
Road Surface Description:	Dry				
Speed Limit:	60				
Light Conditions:	Daylight: regardless of presence of streetlights				
Carriageway Hazards:	None				
Junction Detail:	Roundabout				
Junction Pedestrian Crossing:	No physical crossing facility within 50 metres				
Road Type:	Roundabout				
Junction Control:	Give way or uncontrolled				

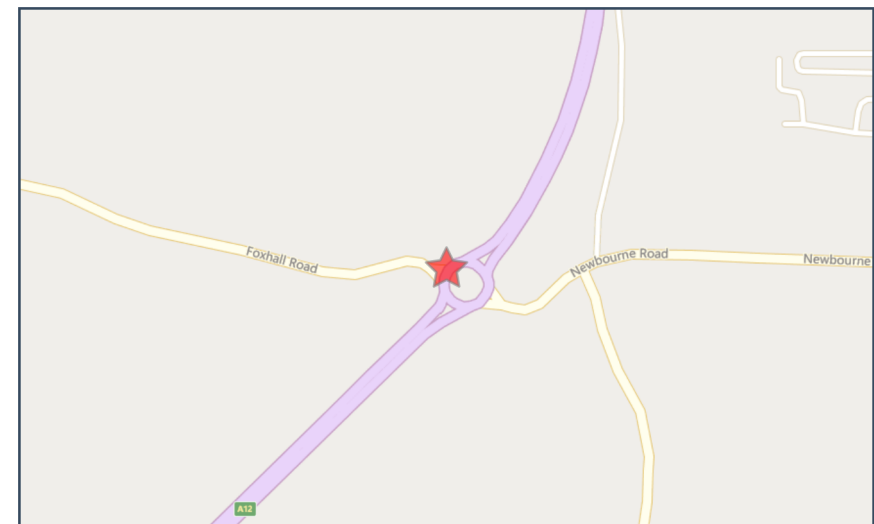

For more information about the data please visit: www.crashmap.co.uk/home/Faq
To subscribe to unlimited reports using CrashMap Pro visit www.crashmap.co.uk/Home/Premium_Services



Validated Data

Vehicles involved

Vehicle Ref	Vehicle Type	Vehicle Age	Driver Gender	Driver Age Band	Vehicle Maneouvre	First Point of Impact	Journey Purpose	Hit Object - On Carriageway	Hit Object - Off Carriageway
1	Car (excluding private hire)	9	Male	Over 75	Vehicle is slowing down or stopping	Front	Other	None	None
2	Car (excluding private hire)	10	Female	36 - 45	Vehicle is waiting to proceed normally but is held up	Back	Other	None	None

Casualties

Vehicle Ref	Casualty Ref	Injury Severity	Casualty Class	Gender	Age Band	Pedestrian Location	Pedestrian Movement
2	1	Slight	Vehicle or pillion passenger	Female	Over 75	Unknown or other	Unknown or other

For more information about the data please visit: www.crashmap.co.uk/home/Faq

To subscribe to unlimited reports using CrashMap Pro visit www.crashmap.co.uk/Home/Premium_Services



Validated Data

Crash Date: Sunday, December 13, 2015 **Time of Crash:** 1:14:00 PM **Crash Reference:** 201537EA96211

Highest Injury Severity:	Slight	Road Number:	A12	Number of Casualties:	2
Highway Authority:	Suffolk	Number of Vehicles:	2	OS Grid Reference:	624620 243925
Local Authority:	Suffolk Coastal District				
Weather Description:	Fine without high winds				
Road Surface Description:	Dry				
Speed Limit:	60				
Light Conditions:	Daylight: regardless of presence of streetlights				
Carriageway Hazards:	None				
Junction Detail:	Roundabout				
Junction Pedestrian Crossing:	No physical crossing facility within 50 metres				
Road Type:	Roundabout				
Junction Control:	Give way or uncontrolled				

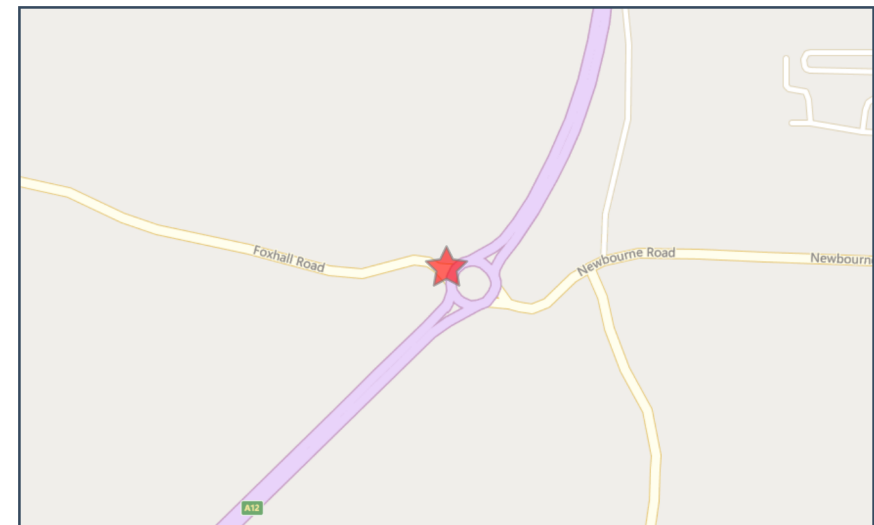

For more information about the data please visit: www.crashmap.co.uk/home/Faq
To subscribe to unlimited reports using CrashMap Pro visit www.crashmap.co.uk/Home/Premium_Services



Validated Data

Vehicles involved

Vehicle Ref	Vehicle Type	Vehicle Age	Driver Gender	Driver Age Band	Vehicle Maneouvre	First Point of Impact	Journey Purpose	Hit Object - On Carriageway	Hit Object - Off Carriageway
1	Car (excluding private hire)	-1	Female	26 - 35	Vehicle is slowing down or stopping	Front	Other	None	None
2	Car (excluding private hire)	9	Male	26 - 35	Vehicle is waiting to proceed normally but is held up	Back	Other	None	None

Casualties

Vehicle Ref	Casualty Ref	Injury Severity	Casualty Class	Gender	Age Band	Pedestrian Location	Pedestrian Movement
2	1	Slight	Vehicle or pillion passenger	Female	26 - 35	Unknown or other	Unknown or other
2	2	Slight	Vehicle or pillion passenger	Female	26 - 35	Unknown or other	Unknown or other

For more information about the data please visit: www.crashmap.co.uk/home/Faq

To subscribe to unlimited reports using CrashMap Pro visit www.crashmap.co.uk/Home/Premium_Services



Validated Data

Crash Date: Tuesday, April 12, 2016 **Time of Crash:** 9:15:00 AM **Crash Reference:** 2016370062614

Highest Injury Severity:	Slight	Road Number:	U0	Number of Casualties:	1
Highway Authority:	Suffolk			Number of Vehicles:	2
Local Authority:	Ipswich Borough			OS Grid Reference:	624616 243945
Weather Description:	Raining without high winds				
Road Surface Description:	Wet or Damp				
Speed Limit:	60				
Light Conditions:	Daylight: regardless of presence of streetlights				
Carriageway Hazards:	None				
Junction Detail:	Roundabout				
Junction Pedestrian Crossing:	No physical crossing facility within 50 metres				
Road Type:	Single carriageway				
Junction Control:	Give way or uncontrolled				

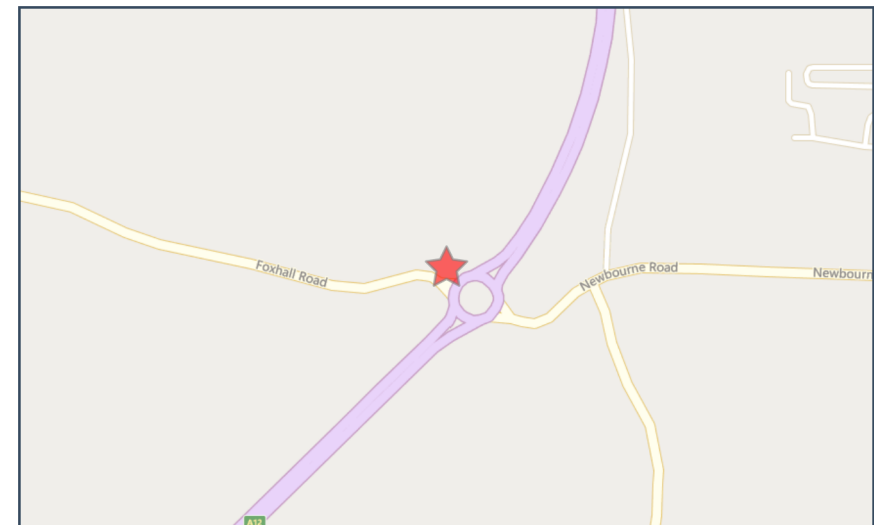

For more information about the data please visit: www.crashmap.co.uk/home/Faq
To subscribe to unlimited reports using CrashMap Pro visit www.crashmap.co.uk/Home/Premium_Services



Validated Data

Vehicles involved

Vehicle Ref	Vehicle Type	Vehicle Age	Driver Gender	Driver Age Band	Vehicle Maneouvre	First Point of Impact	Journey Purpose	Hit Object - On Carriageway	Hit Object - Off Carriageway
1	Car (excluding private hire)	11	Female	26 - 35	Vehicle is moving off	Front	Other	None	None
2	Car (excluding private hire)	4	Female	46 - 55	Vehicle is moving off	Back	Other	None	None

Casualties

Vehicle Ref	Casualty Ref	Injury Severity	Casualty Class	Gender	Age Band	Pedestrian Location	Pedestrian Movement
1	1	Slight	Driver or rider	Female	26 - 35	Unknown or other	Unknown or other

For more information about the data please visit: www.crashmap.co.uk/home/Faq

To subscribe to unlimited reports using CrashMap Pro visit www.crashmap.co.uk/Home/Premium_Services



Validated Data

Crash Date: Friday, March 20, 2015 **Time of Crash:** 2:55:00 PM **Crash Reference:** 201537EA89055

Highest Injury Severity:	Slight	Road Number:	A12	Number of Casualties:	1
Highway Authority:	Suffolk			Number of Vehicles:	2
Local Authority:	Suffolk Coastal District			OS Grid Reference:	624624 243883
Weather Description:	Fine without high winds				
Road Surface Description:	Dry				
Speed Limit:	70				
Light Conditions:	Daylight: regardless of presence of streetlights				
Carriageway Hazards:	None				
Junction Detail:	Roundabout				
Junction Pedestrian Crossing:	No physical crossing facility within 50 metres				
Road Type:	Roundabout				
Junction Control:	Give way or uncontrolled				

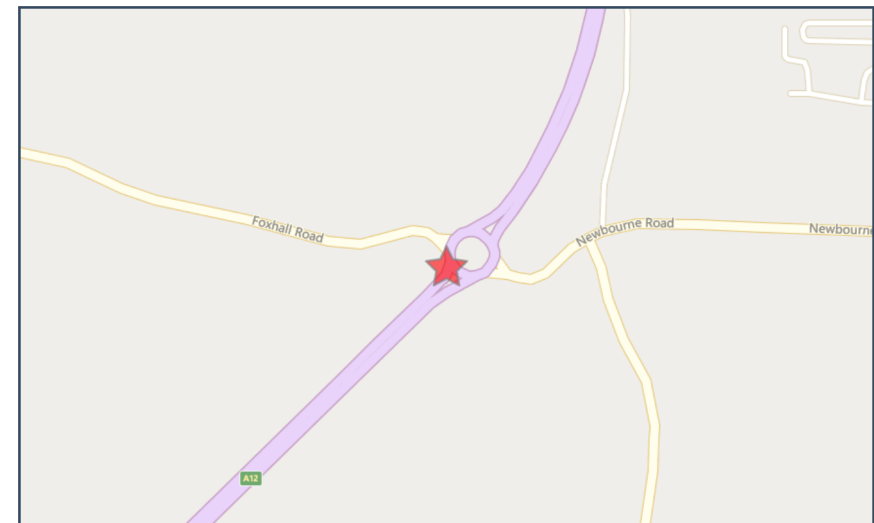

For more information about the data please visit: www.crashmap.co.uk/home/Faq
To subscribe to unlimited reports using CrashMap Pro visit www.crashmap.co.uk/Home/Premium_Services



Validated Data

Vehicles involved

Vehicle Ref	Vehicle Type	Vehicle Age	Driver Gender	Driver Age Band	Vehicle Maneouvre	First Point of Impact	Journey Purpose	Hit Object - On Carriageway	Hit Object - Off Carriageway
1	Car (excluding private hire)		6 Female	26 - 35	Vehicle proceeding normally along the carriageway, not on a bend	Front	Other	None	None
2	Motorcycle over 500cc		-1 Male	Over 75	Vehicle is waiting to proceed normally but is held up	Back	Other	None	None

Casualties

Vehicle Ref	Casualty Ref	Injury Severity	Casualty Class	Gender	Age Band	Pedestrian Location	Pedestrian Movement
	2	1 Slight	Driver or rider	Male	Over 75	Unknown or other	Unknown or other

For more information about the data please visit: www.crashmap.co.uk/home/Faq

To subscribe to unlimited reports using CrashMap Pro visit www.crashmap.co.uk/Home/Premium_Services



Validated Data

Crash Date:	Wednesday, November 06, 2019	Time of Crash:	11:52:00 AM	Crash Reference:	2019370922692
Highest Injury Severity:	Slight	Road Number:	A12	Number of Casualties:	2
Highway Authority:	Suffolk			Number of Vehicles:	2
Local Authority:	Suffolk Coastal District			OS Grid Reference:	624625 243898
Weather Description:	Fine without high winds				
Road Surface Description:	Dry				
Speed Limit:	70				
Light Conditions:	Daylight: regardless of presence of streetlights				
Carriageway Hazards:	None				
Junction Detail:	Roundabout				
Junction Pedestrian Crossing:	No physical crossing facility within 50 metres				
Road Type:	Roundabout				
Junction Control:	Give way or uncontrolled				

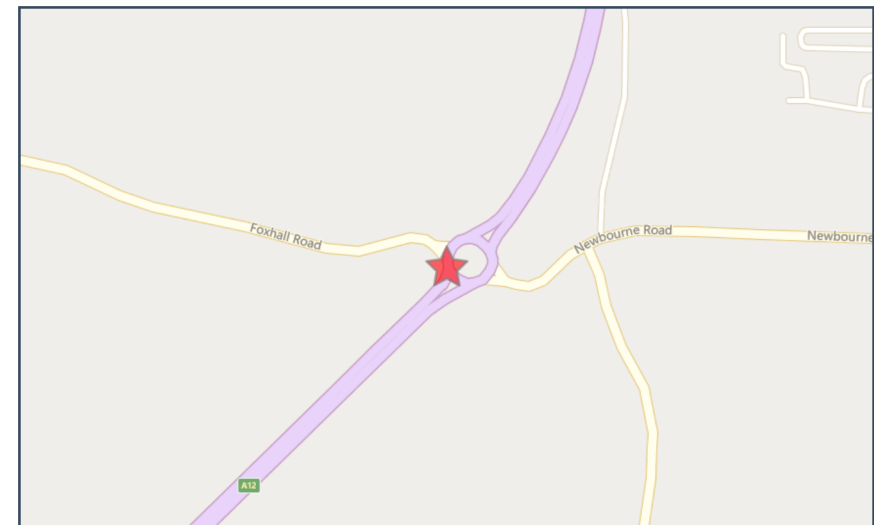

For more information about the data please visit: www.crashmap.co.uk/home/Faq
To subscribe to unlimited reports using CrashMap Pro visit www.crashmap.co.uk/Home/Premium_Services



Validated Data

Vehicles involved

Vehicle Ref	Vehicle Type	Vehicle Age	Driver Gender	Driver Age Band	Vehicle Maneouvre	First Point of Impact	Journey Purpose	Hit Object - On Carriageway	Hit Object - Off Carriageway
1	Car (excluding private hire)		3 Female	66 - 75	Vehicle proceeding normally along the carriageway, not on a bend	Front	Other	None	None
2	Car (excluding private hire)		7 Male	36 - 45	Vehicle proceeding normally along the carriageway, not on a bend	Back	Other	None	None

Casualties

Vehicle Ref	Casualty Ref	Injury Severity	Casualty Class	Gender	Age Band	Pedestrian Location	Pedestrian Movement
2	1	Slight	Driver or rider	Male	36 - 45	Unknown or other	Unknown or other
2	2	Slight	Vehicle or pillion passenger	Male	36 - 45	Unknown or other	Unknown or other

For more information about the data please visit: www.crashmap.co.uk/home/Faq

To subscribe to unlimited reports using CrashMap Pro visit www.crashmap.co.uk/Home/Premium_Services

EUROPEAN OFFICES

United Kingdom

AYLESBURY

T: +44 (0)1844 337380

BELFAST

belfast@slrconsulting.com

BRADFORD-ON-AVON

T: +44 (0)1225 309400

BRISTOL

T: +44 (0)117 906 4280

CARDIFF

T: +44 (0)29 2049 1010

CHELMSFORD

T: +44 (0)1245 392170

EDINBURGH

T: +44 (0)131 335 6830

EXETER

T: + 44 (0)1392 490152

GLASGOW

glasgow@slrconsulting.com

GUILDFORD

guildford@slrconsulting.com

LONDON

T: +44 (0)203 805 6418

MAIDSTONE

T: +44 (0)1622 609242

MANCHESTER (Denton)

T: +44 (0)161 549 8410

MANCHESTER (Media City)

T: +44 (0)161 872 7564

NEWCASTLE UPON TYNE

T: +44 (0)191 261 1966

NOTTINGHAM

T: +44 (0)115 964 7280

SHEFFIELD

T: +44 (0)114 245 5153

SHREWSBURY

T: +44 (0)1743 23 9250

STIRLING

T: +44 (0)1786 239900

WORCESTER

T: +44 (0)1905 751310

Ireland

DUBLIN

T: + 353 (0)1 296 4667

France

GRENOBLE

T: +33 (0)6 23 37 14 14

613000



249000

249000

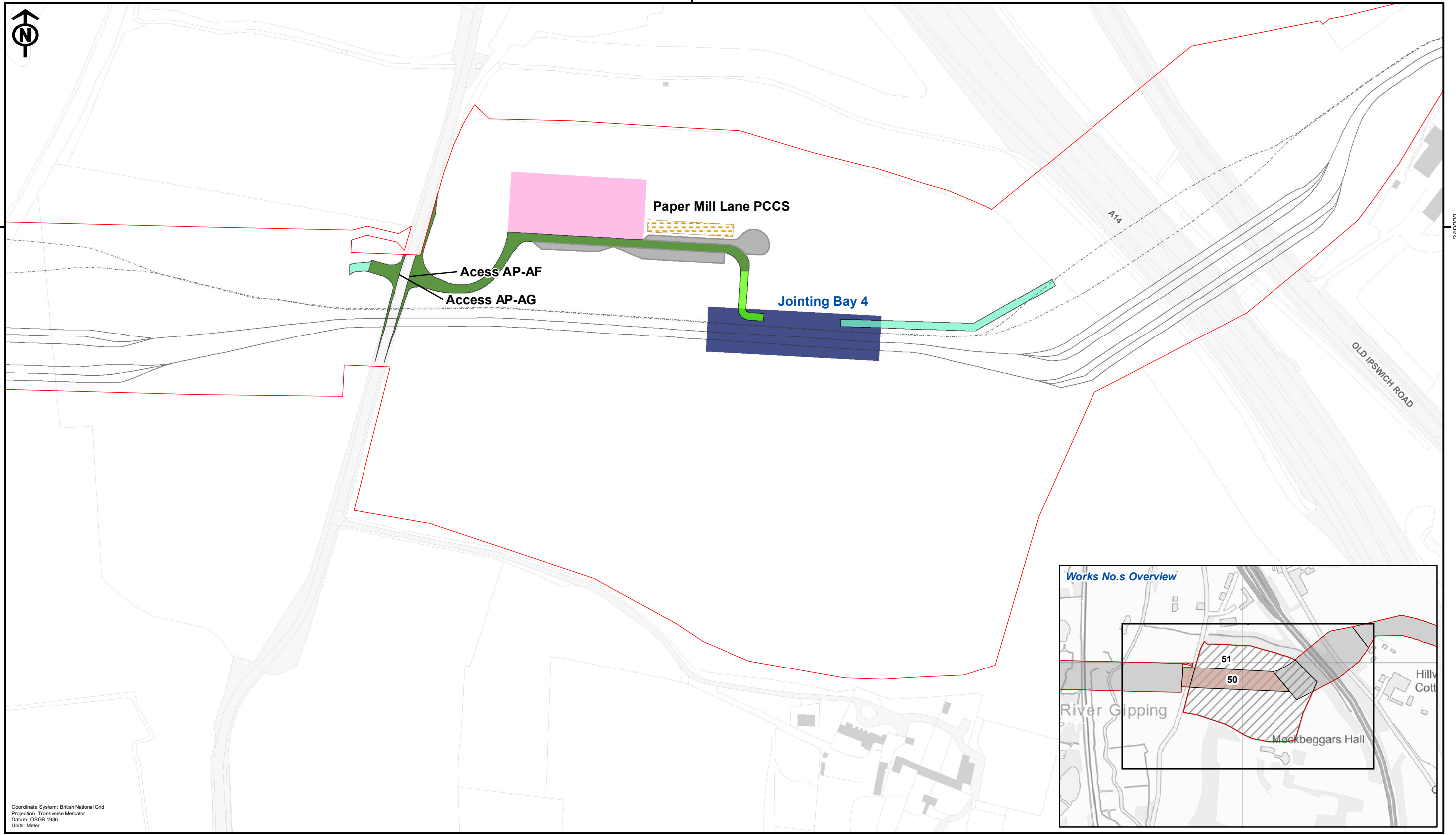

Coordinate System: British National Grid
 Projection: Transverse Mercator
 Datum: OSGB 1936
 Units: Meter

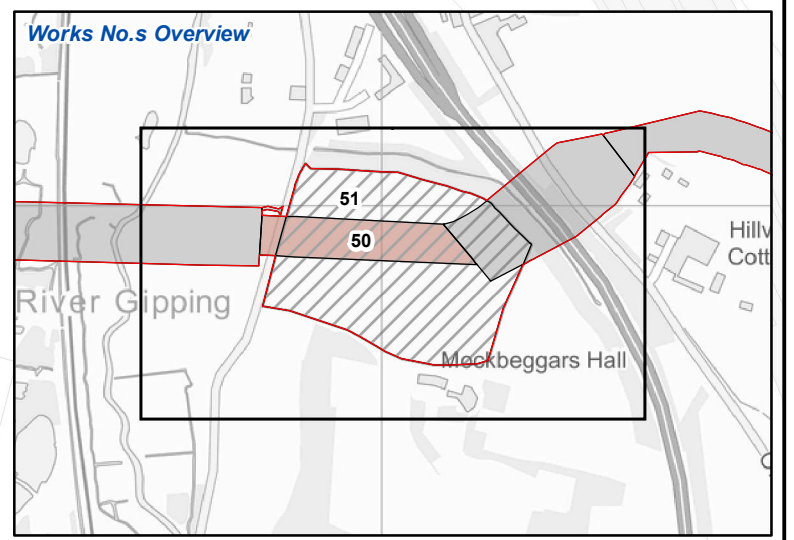

EA THREE DCO Corridor	HGV Turning, Cleaning and Washing	EA THREE Existing Cable Ducts	Works No.s 50 51
Primary Construction Consolidation Site	Trackway	EA ONE Existing Cable Ducts	
Jointing Bay Compound	Access Track		
Top Soil	Haul Road		



Rev	Date	By	Comment
B	05/04/2022	PW	Second Issue
A	31/03/2022	JRS	First Issue

Original A3 Plot Scale 1:2,500

0 50 100 Metres

© Crown copyright. All rights reserved. 2021 Licence number 0100031673.
 © British Crown and SeaZone Solutions Limited. All rights reserved. Products Licence No. 062010.001. This product has been derived in part from material obtained from the UK Hydrographic Office with the permission of the Controller of Her Majesty's Stationery Office and the UK Hydrographic Office (www.ukho.gov.uk).
 NOT TO BE USED FOR NAVIGATION.

Paper Mill Lane Works Stage

Figure 1: Site Context Plan

Drg No	05356.00006.12.0021.1 Site Context Plan
Rev	2
Date	05/04/2022
Layout	N/A

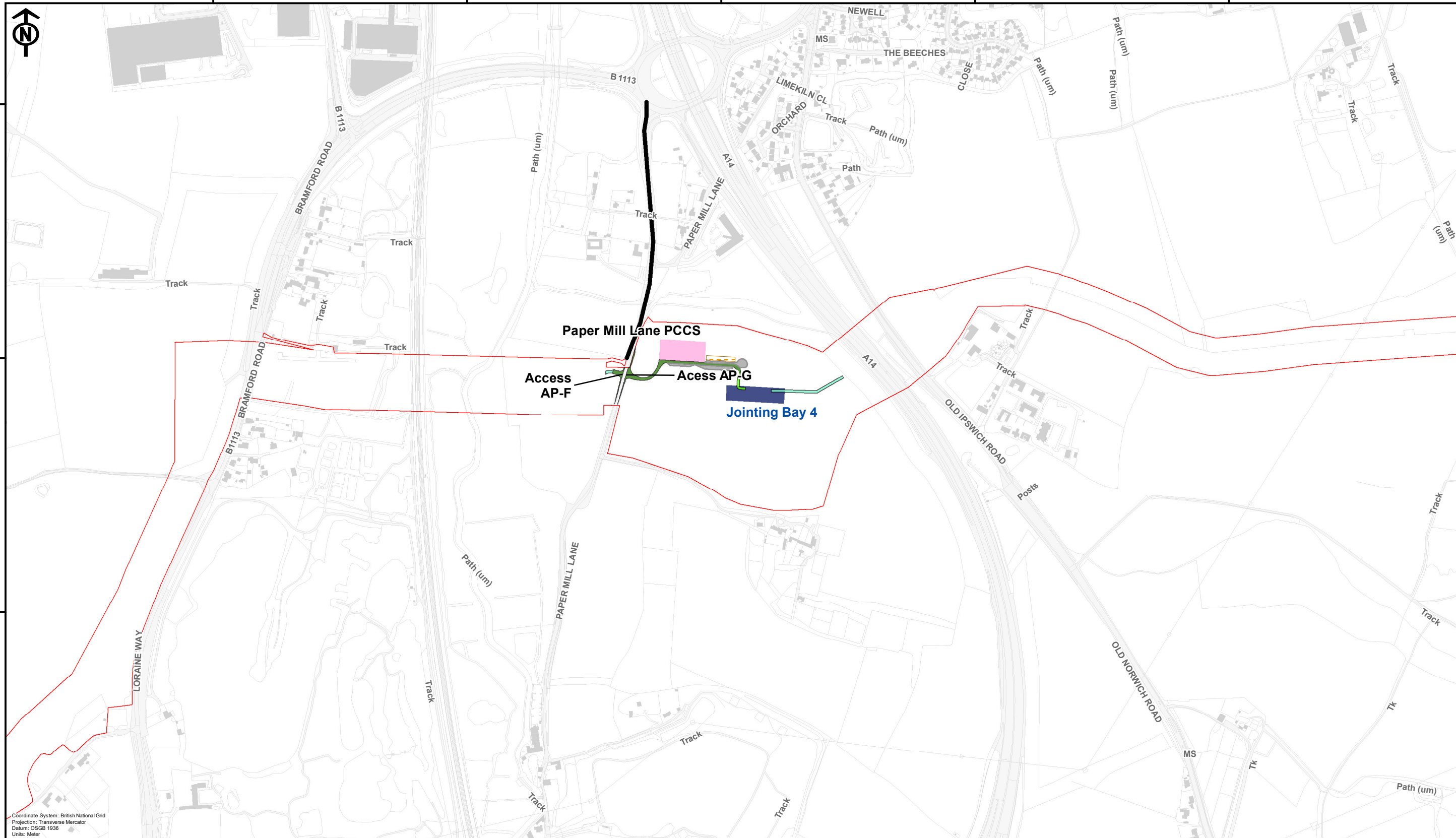

Coordinate System: British National Grid
 Projection: Transverse Mercator
 Datum: OSGB 1936
 Units: Meter

EA THREE DCO Corridor	HGV Turning, Cleaning and Washing	Top Soil
Primary Construction Consolidation Site	Trackway	Construction Access Route
Jointing Bay Compound	Access Track	
	Haul Road	



Rev	Date	By	Comment
B	12/04/2022	PW	Second Issue
A	31/01/2022	PW	First Issue

Original A3 Plot Scale 1:7,500

0 150 300 Metres

© Crown copyright. All rights reserved. 2021 Licence number 0100031673.
 © British Crown and SeaZone Solutions Limited. All rights reserved. Products Licence No. 082010.001. This product has been derived in part from material obtained from the UK Hydrographic Office with the permission of the Controller of Her Majesty's Stationery Office and the UK Hydrographic Office (www.ukho.gov.uk).
 NOT TO BE USED FOR NAVIGATION.

Paper Mill Lane Works Stage

Figure 2: Construction Access Route

Drg No	05356.00006.12.0078.1 Construction Access Route
Rev	2
Date	12/04/2022
Layout	N/A